



# MISSION BOULEVARD CODE

City of Hayward, California  
Public Hearing Draft | May 2020

*This page intentionally left blank.*

# CONTENTS

## Article 1: Introduction

<b>Division 1.1 Purpose and Intent</b>	<b>1-3</b>
1.1.010 Purpose and Intent .....	1-3
1.1.020 Effective Date .....	1-3
1.1.030 Applicability .....	1-4
1.1.040 Organization and Use .....	1-4
1.1.050 Rules of Interpretation .....	1-5

## Article 2: Specific to Zones

<b>Division 2.1: Establishment of Zones</b>	<b>2-3</b>
2.1.010 Zones Established .....	2-3
2.1.020 Zoning Map .....	2-3
<b>Division 2.2: Mission Boulevard Corridor Zones</b>	<b>2-7</b>
2.2.010 Purpose .....	2-7
2.2.020 Applicability .....	2-7
2.2.030 Overview of Mission Boulevard Corridor Zones .....	2-8
2.2.040 Mission Boulevard - Corridor Neighborhood (MB-CN) .....	2-10
2.2.050 Mission Boulevard - Neighborhood Node (MB-NN) .....	2-14
2.2.060 Mission Boulevard - Corridor Center (MB-CC) .....	2-18
<b>Division 2.3: Use Tables</b>	<b>2-23</b>
2.3.010 Allowed Land Uses and Permit Requirements .....	2-23

## Article 3: Supplemental to Zones

<b>Division 3.1 Purpose and Intent</b>	<b>3-3</b>
3.1.010 Purpose and Intent .....	3-3
3.1.020 Applicability .....	3-3
<b>Division 3.2: General Standards</b>	<b>3-5</b>
3.2.010 Architectural Standards .....	3-5
3.2.020 Mechanical and Electrical Equipment .....	3-6

3.2.030	Exterior and Parking Lot Lighting . . . . .	3-6
3.2.040	Fences and Walls . . . . .	3-6
3.2.050	Parking and loading . . . . .	3-7
3.2.060	Landscaping . . . . .	3-9
3.2.070	Air Quality Mitigation Measures . . . . .	3-10
3.2.080	Visitability Standards . . . . .	3-11
3.2.090	Sustainability Plan . . . . .	3-11

---

<b>Division 3.3 Specific to Frontage Types</b>	<b>3-13</b>
--	-------------

3.3.010	Purpose . . . . .	3-13
3.3.020	Applicability . . . . .	3-13
3.3.030	Overview . . . . .	3-14
3.3.040	General to Private Frontages . . . . .	3-14
3.3.050	Front Yard . . . . .	3-15
3.3.060	Porch: Projecting . . . . .	3-16
3.3.070	Porch: Engaged . . . . .	3-17
3.3.080	Stoop . . . . .	3-18
3.3.090	Forecourt . . . . .	3-19
3.3.100	Dooryard . . . . .	3-20
3.3.110	Maker Shopfront . . . . .	3-21
3.3.120	Shopfront . . . . .	3-22
3.3.130	Terrace . . . . .	3-23
3.3.140	Gallery . . . . .	3-24

---

<b>Division 3.4 Specific to Civic Spaces</b>	<b>3-25</b>
--	-------------

3.4.010	Purpose . . . . .	3-25
3.4.020	Applicability . . . . .	3-25
3.4.030	Overview . . . . .	3-26
3.4.040	General to All Civic Spaces . . . . .	3-26
3.4.050	Greenway . . . . .	3-28
3.4.060	Green . . . . .	3-29
3.4.070	Square . . . . .	3-30
3.4.080	Pocket Plaza . . . . .	3-31
3.4.090	Playground . . . . .	3-32

---

<b>Division 3.5 Specific to Uses</b>	<b>3-33</b>
--------------------------------------	-------------

3.5.010	Telecommunication Facilities . . . . .	3-33
---------	--	------

3.5.020	Temporary Uses .....	3-34
---------	----------------------	------

---

<b>Division 3.6: Standards for Large Sites</b>	<b>3-39</b>
--	-------------

3.6.010	Purpose and Applicability.....	3-39
3.6.020	Major Site Plan Required.....	3-39
3.6.030	Development Requirements .....	3-40

## Article 4: Permits and Procedures

---

<b>Division 4.1 Purpose</b>	<b>4-3</b>
-----------------------------	------------

4.1.010	Purpose .....	4-3
4.1.020	Applicability.....	4-3

---

<b>Division 4.2 Site Plan Review</b>	<b>4-5</b>
--------------------------------------	------------

4.2.010	Site Plan Review .....	4-5
4.2.020	Major Site Plan Review .....	4-5

---

<b>Division 4.3 Minor Modifications</b>	<b>4-7</b>
---	------------

4.3.010	Modification .....	4-7
4.3.010	Purpose and Applicability.....	4-7
4.3.020	Review Procedures.....	4-7
4.3.030	Modification Allowed.....	4-8
4.3.040	Findings for a Decision on a Minor Modification .....	4-9
4.3.050	Review and Decision .....	4-9

---

<b>Division 4.4 Temporary Use Permit</b>	<b>4-11</b>
--	-------------

4.4.010	Purpose and Applicability.....	4-11
4.4.020	Review Procedures.....	4-11
4.4.030	Findings .....	4-12
4.4.040	Lapse of Approval.....	4-12
4.4.050	Time Limits .....	4-13
4.4.060	Appeals.....	4-13

## Article 5: Definitions

---

<b>Division 5.1 General Terms and Definitions</b>	<b>5-3</b>
---	------------

5.1.010	Purpose and Intent .....	5-3
5.1.020	Land Uses .....	5-3

Table of Contents

5.1.030      General Terms..... 5-3

# Article 1: Introduction

## Contents

---

<b>Division 1.1 Purpose and Intent</b>	<b>1-3</b>
1.1.010 Purpose and Intent .....	1-3
1.1.020 Effective Date .....	1-3
1.1.030 Applicability.....	1-4
1.1.040 Organization and Use .....	1-4
1.1.050 Rules of Interpretation .....	1-5

*This page intentionally left blank*



## Division 1.1 Purpose and Intent

---

### Sections

1.1.010	Purpose and Intent . . . . .	1-3
1.1.020	Effective Date . . . . .	1-3
1.1.030	Applicability . . . . .	1-4
1.1.040	Organization and Use . . . . .	1-4
1.1.050	Rules of Interpretation . . . . .	1-5

---

### 1.1.010 Purpose and Intent

- A. This Chapter of the Hayward Municipal Code shall be known, and may be cited, as the Mission Boulevard Corridor Code. References to “Code” within this Chapter are references to the Mission Boulevard Corridor Code unless the text indicates otherwise. References to the “Municipal Code” refer to the Hayward Municipal Code and references to “Hayward Zoning Code” refer to [Chapter 10 of the Hayward Municipal Code](#).
- B. This Code carries out the policies of the Hayward General Plan for the Mission Boulevard Corridor Code Area (Code Area) identified in [Figure 2.1.020.1 \(Mission Boulevard Code Regulating Plan\)](#) by classifying and regulating the types and intensities of development and land uses within the Code Area consistent with, and in furtherance of, the policies and objectives of the General Plan. This Code is adopted to protect and promote the public health, safety, comfort, convenience, prosperity, and general welfare of the community.
- C. This Code is a tool for implementing the goals, objectives, and policies of the Hayward General Plan, pursuant to the mandated provisions of the State Planning and Zoning Law, the California Environmental Quality Act, and other applicable State and local requirements.

---

### 1.1.020 Effective Date

The Mission Boulevard Corridor Code has an effective date of [{to be completed}](#).

---

### 1.1.030 Applicability

- A. This Code applies to all land uses, subdivisions, and development within the Code Area identified in [Figure 2.1.020.1 \(Mission Boulevard Code Regulating Plan\)](#).
- B. It shall be unlawful and a violation of this Code for any person to establish, construct, reconstruct, enlarge, alter, or replace any use of land or structure, except in compliance with the requirements listed below, including those relating to nonconforming uses, structures, and parcels. No building permit or grading permit shall be issued by the City unless the proposed construction complies with all applicable provisions of this Code.
- C. This Code supplements, or when in conflict replaces, the standards and procedures in [Chapter 10 \(Planning, Zoning, and Subdivisions\) of the Municipal Code](#). All applicable provisions of the Municipal Code that are not specifically replaced or identified as not applicable continue to apply to all properties within the Code Area. If there is a conflict between the standards of this Chapter and the standards in the Municipal Code, the standards in this Chapter supersede unless otherwise stated.
- D. **Minimum Requirements.** The provisions of this Code are minimum requirements for the protection and promotion of the public health, safety, comfort, convenience, prosperity, and general welfare. When this Code provides for discretion on the part of a City official or body, that discretion may be exercised to impose conditions on the approval of any project proposed in the Code Area, as may be determined by the Review Authority to be necessary to establish or promote development and land use, environmental resource protection, and the other purposes of this Code
- E. **Non-Conforming Structures and Land Uses.** Nonconforming structures and/or nonconforming use(s) legally existing when this Code was adopted must comply with [Section 10-1.2900 \(Nonconforming Uses\)](#) of the Hayward Zoning Code.
- F. **Effect of Zoning Code Changes on Projects in Progress.** An application for zoning approval that has been deemed complete by the Planning Director before the effective date of the ordinance codified in this Code or any amendment will be processed according to the requirements in effect when the review authority first considers the application in a public hearing.

---

### 1.1.040 Organization and Use

The Code consists of the following Articles:

1. **Article 1 Introduction.** This Article establishes the purpose of the Code and explains how existing and new standards will be applied to property within the boundaries of the Code Area identified in [Figure 2.1.020.1 \(Mission Boulevard Code Regulating Plan\)](#).
2. **Article 2 Specific to Zones.** This Article establishes and defines the zones for the Code Area and specifies the allowed uses, permit requirements, and development standards for each zone.
3. **Article 3 Supplemental to Zone.** This Article establishes general, frontage, and civic space standards for the zones. This Article also defines the character of each frontage and civic space type. This Article also provides additional standards and requirements that apply to a specific use, subdivisions, and air quality mitigation measures.

4. **Article 4 Permits and Procedures.** This Article describes the permitting and processing procedures that apply to property within the boundaries of the Code Area.
5. **Article 5 Definitions.** This Article provides definitions of terms used in the Code. This Article supplements, and when in conflict, replaces the definitions in [Section 10-1.3500 \(Definitions\) of the Hayward Zoning Code](#).

---

## 1.1.050 Rules of Interpretation

- A. Provisions of this Code are activated by “shall” or “must” when required; “should” when recommended; and “may” when optional.
- B. Terms used throughout this Code are defined in [Article 5 \(Definitions\)](#). Terms not defined in [Article 5](#) shall be as defined in [Section 10-1.3500 \(Definitions\) of the Hayward Zoning Code](#). Terms not defined in [Article 5](#) or [Section 10-1.3500](#) shall be accorded their commonly accepted meanings.
- C. Diagrams and figures that accompany tables and text are considered examples, and are not regulatory. Diagrams may not be to scale.
- D. Where in conflict, numerical metrics shall take precedence over graphic metrics.
- E. Within the Code, sections are occasionally prefaced with “purpose” or “intent” statements. Each such statement is intended as an official statement of legislative finding or purpose. The “purpose” or “intent” statements are legislatively adopted, together with their accompanying Code text. They are intended as a guide to the administrator and interpretation of the Code and shall be treated in the same manner as other aspects of legislative history. However, they are not binding standards.
- F. The Planning Director may make interpretations of this Code in compliance with [Hayward Zoning Code Section 10-1.120 \(Reviewing Authorities\)](#) and may refer any interpretation to the Planning Commission in compliance with [Hayward Zoning Code Section 10-1.2840 \(Administrative Referral\)](#).
- G. Any interpretation of this Code by the Planning Director may be appealed to the Planning Commission in compliance with [Section 10-1.2845 \(Appeal and Review Process\) of the Hayward Zoning Code](#).

*This page intentionally left blank*

# Article 2: Specific to Zones

<b>Division 2.1: Establishment of Zones</b>		<b>2-3</b>
2.1.010	Zones Established .....	2-3
2.1.020	Zoning Map .....	2-3
<b>Division 2.2: Mission Boulevard Corridor Zones</b>		<b>2-7</b>
2.2.010	Purpose .....	2-7
2.2.020	Applicability .....	2-7
2.2.030	Overview of Mission Boulevard Corridor Zones .....	2-8
2.2.040	Mission Boulevard - Corridor Neighborhood (MB-CN) .....	2-10
2.2.050	Mission Boulevard - Neighborhood Node (MB-NN) .....	2-14
2.2.060	Mission Boulevard - Corridor Center (MB-CC) .....	2-18
<b>Division 2.3: Use Tables</b>		<b>2-23</b>
2.3.010	Allowed Land Uses and Permit Requirements .....	2-23

*This page intentionally left blank*

## Division 2.1: Establishment of Zones

---

### Sections

2.1.010	Zones Established . . . . .	2-3
2.1.020	Zoning Map. . . . .	2-3

---

### 2.1.010 Zones Established

This Article establishes the zones applied to property within the Code Area, adopts the Mission Boulevard Code Regulating Plan for the Code Area as its Zoning Map, and establishes standards applicable to zones.

---

### 2.1.020 Zoning Map

The City Council hereby adopts the Mission Boulevard Code Regulating Plan (hereafter referred to as the “Regulating Plan”), as shown in [Figure 1](#), as an amendment to the zoning district map authorized by [Municipal Code Section 10-1.3400 \(Amendments\)](#). The Regulating Plan acts as the Zoning Map for the Code Area.

Most of the Mission Boulevard Code area is designated as Priority Development Areas (PDA) per the Bay Area Regional Transportation Plan and Sustainable Communities Strategy which both encourage growth within compact, mixed-use, and walkable neighborhoods and districts that are located near Hayward’s job centers and regional transit facilities such as the Hayward BART and South Hayward BART stations. Along the Mission Boulevard corridor, there is significant variation in parcel sizes and topography. The northern portion of the Regulating Plan between Harder Road and Rose Street primarily comprises of parcels that are small and narrow that include existing single-family homes and single-story commercial structures may be limited in their development potential. The southern end of the Regulating Plan (south of Harder Road) consists of larger sites that may accommodate larger-scale developments. Per the Hayward 2040 General Plan, the Mission Boulevard Code area is expected to change and will include higher-density developments with 3-5 story structures contingent on geological conditions and site suitability. Developments within the Mission Boulevard Code area will decrease dependency on the automobile and allow more people to walk, bike, or take transit for commute and daily trips. This will help reduce automobile use, local and regional traffic congestion, and related greenhouse gas emissions.

2.1.020

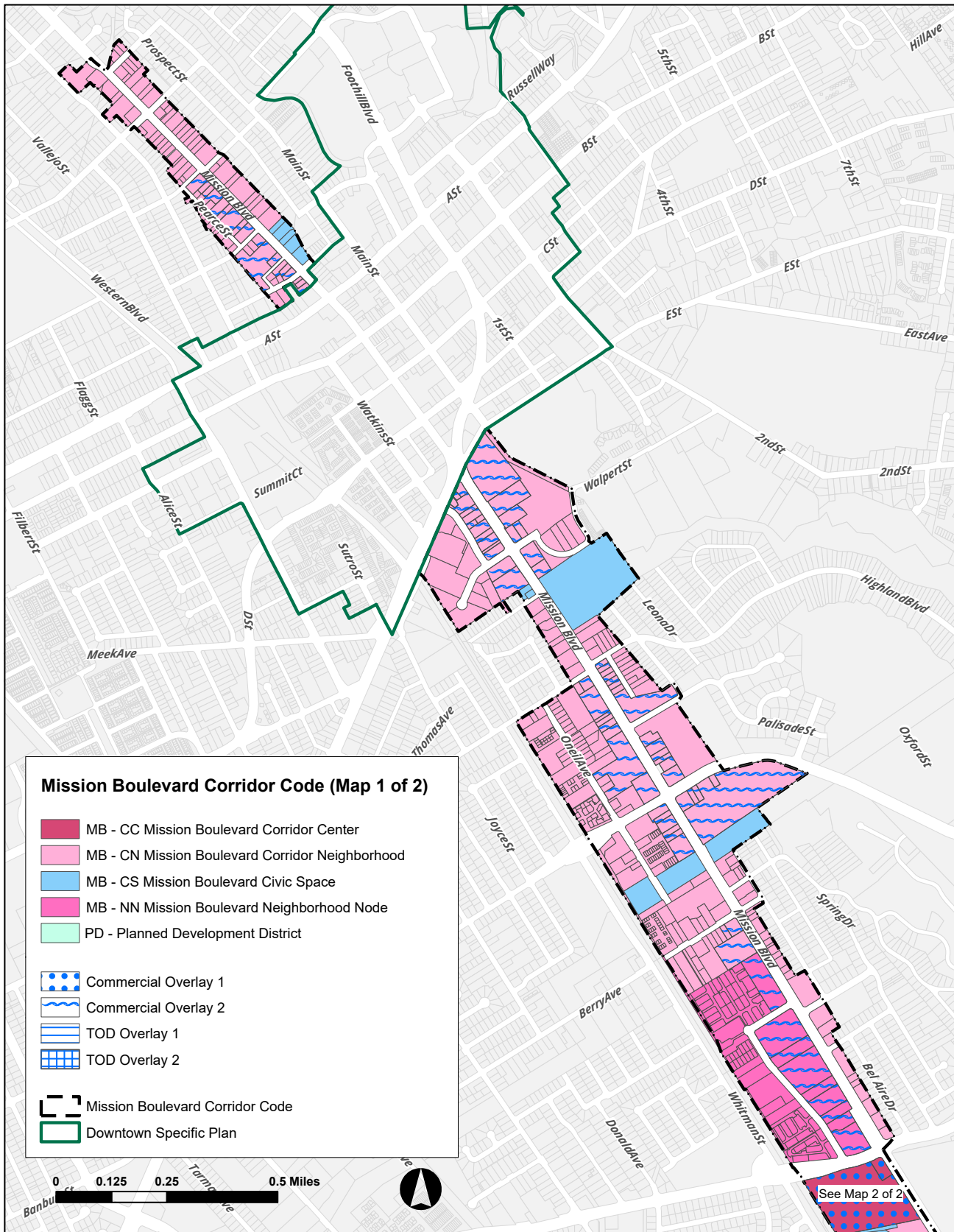

Figure 2.1.020.1A Mission Boulevard Code Regulating Plan



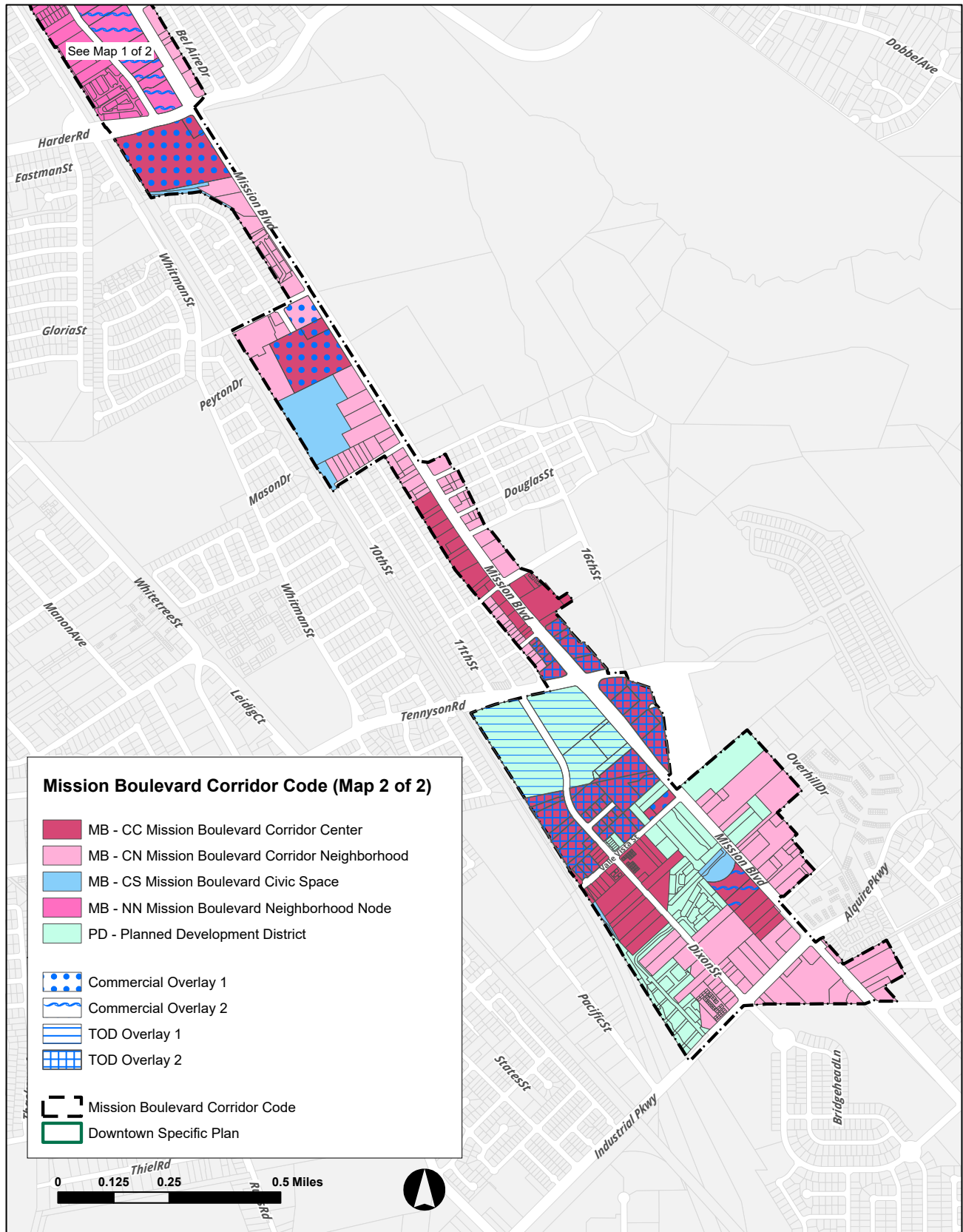

Figure 2.1.020.1B Mission Boulevard Code Regulating Plan

*This page intentionally left blank*

## Division 2.2: Mission Boulevard Corridor Zones

---

### Sections

2.2.010	Purpose .....	2-7
2.2.020	Applicability .....	2-7
2.2.030	Overview of Mission Boulevard Corridor Zones .....	2-8
2.2.040	Mission Boulevard - Corridor Neighborhood (MB-CN) .....	2-10
2.2.050	Mission Boulevard - Neighborhood Node (MB-NN) .....	2-14
2.2.060	Mission Boulevard - Corridor Center (MB-CC) .....	2-18

---



### 2.2.010 Purpose

This Division establishes the zones applied to property within the Mission Boulevard Corridor Code Area and establishes standards applicable to zones.

---

### 2.2.020 Applicability

- A. The standards in this Division apply to all proposed land uses and development within Mission Boulevard Corridor Code Area.
- B. All applicable provisions of Chapter 10 (Planning, Zoning, and Subdivisions) of the Municipal Code that are not specifically replaced or identified as not applicable continue to apply, unless otherwise provided.
- C. If there is a conflict between the standards of this Division and the standards in another Division or Article of the Mission Boulevard Corridor Code or with the Municipal Code, the standards in this Division supersede the Municipal Code and Article 3 (Supplemental to Zones) supersedes this Division.

<p><b>Mission Boulevard - Corridor Neighborhood</b></p>	<p><b>Mission Boulevard - Neighborhood Node</b></p>	<p><b>Mission Boulevard - Corridor Center</b></p>
		
<p><b>Zone(s)</b> Mission Boulevard - Corridor Neighborhood (MB-CN)</p>	<p><b>Zone(s)</b> Mission Boulevard - Neighborhood Node (MB-NN)</p>	<p><b>Zone(s)</b> Mission Boulevard - Corridor Center (MB-CC)</p>
<p><b>Intent</b> A mixed-use neighborhood environment with moderate-intensity, medium-scale residential and non-residential uses compatible with surrounding neighborhoods, along a multi-modal corridor within short walking, biking, or bus distance of neighborhood serving retail and service uses.</p>	<p><b>Intent</b> A vibrant, urban neighborhood-serving node supporting mixed-use infill development to provide a range of commercial, retail, entertainment, civic, and moderate intensity residential uses in a more compact urban setting.</p>	<p><b>Intent</b> A transit-oriented mixed-use, urban center with high-intensity, residential and non-residential uses located within close proximity to BART, to facilitate access to BART by biking or walking.</p>

**2.2.030 Overview of Mission Boulevard Corridor Zones**

- A. The Mission Boulevard Corridor Zones are described in this Division, and each zone is established based on the intent of the desired physical form and character of particular environments. Other than the Mission Boulevard - Civic Space (MB-CS) Zone, the zones range in function and intensity from moderate intensity (Mission Boulevard - Corridor Neighborhood), to a higher intensity (Mission Boulevard - Corridor Center). The naming of these zones is based on an overall spectrum of context types from less urban to more urban along the Mission Boulevard Corridor.

1. **Mission Boulevard - Civic Space (MB-CS).** This zone is intended for the provision of public open space, civic buildings, and civic uses. When the MB-CS Zone is applied to privately owned property, the use and building existing at the time this Code comes into effect may continue until the site is redeveloped or becomes under public ownership. Allowed uses and permit requirements are as prescribed in Table 2.3.010.A: Allowed Uses and Permit Requirements. Buildings shall be designed and located in compliance with the standards of the MB-CN.

**B. Overlay Zones**

1. **TOD Overlays.** Properties within close proximity to public transit centers, including BART, as identified on the Mission Boulevard Code, are modified to allow for an increase in residential density and adjusted height regulations.
2. **Commercial Overlay #1.** Properties designated with a Commercial Overlay Zone 1 designation shall not be developed with residential units on the first or ground floor. Uses associated with the residential use, such as leasing office, community space, amenities, etc., are allowed on the ground floor. This requirement may be adjusted through the Major Site Plan Review Process.
3. **Commercial Overlay #2.** Properties designated with a Commercial Overlay Zone 2 designation shall not be developed with residential units along the primary street frontage unless permitted with a conditional use permit.

# Mission Boulevard - Corridor Neighborhood

## 2.2.040 Mission Boulevard - Corridor Neighborhood (MB-CN)



### A. Intent

A mixed-use neighborhood environment with moderate-intensity, medium-scale residential and non-residential uses compatible with surrounding neighborhoods, along a multi-modal corridor within short walking, biking, or bus distance of neighborhood serving retail and service uses.

### B. Density

Minimum <sup>1</sup>	17.5 du/ac
Maximum	35 du/ac
	55 du/ac South of A Street with Major Site Plan Review

*General note: The image above is intended to provide a brief overview of this zone and is illustrative only.*

<sup>1</sup> Reduction in minimum density allowed subject to Major Site Plan Review.

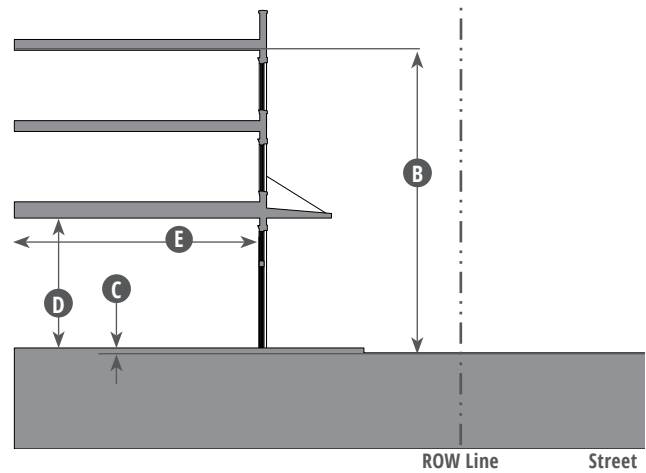
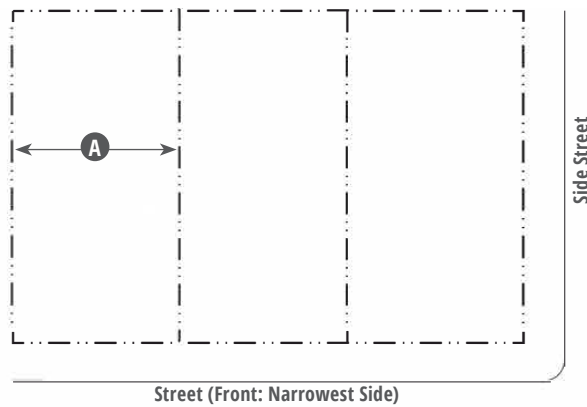

**Key**

--- ROW / Lot Line

**C. Lot Occupation**

Lot Width	18' min.	<b>A</b>
Lot Coverage	80% max.	
Landscaping	15% of lot area, min.	
Open Space	150 sf min. per unit <sup>1</sup>	

<sup>1</sup> Minimum 50 sf must be provided as private usable open space for minimum 50% of the units and minimum 50 sf per unit must be provided as common usable open space. The remaining open space requirement may be met by a combination of private or common usable open space.

**Key**

--- ROW Line

**D. Building Form**

<b>Height</b>		
<b>Main Building</b>		<b>B</b>
Stories- North of A Street	3 max.	
Stories- South of A Street	4 max., 5 max. with Major Site Plan Review	
Overall- South of A Street	57' max., 68' max. with Major Site Plan Review	

<b>Accessory Structure(s)</b>		
Stories	2 max.	

<b>Ground Floor Finish Level</b>		<b>C</b>
Residential	12" min. <sup>1</sup>	
Non-Residential	3' max.	

<b>Ground Floor Ceiling</b>		<b>D</b>
Non-Residential	14' min.	

<b>Other</b>		
<b>Accessory Structure(s)</b>		
Square Feet	440 max.	

<b>Building Depth, Ground-Floor</b>	30' min.	<b>E</b>
-------------------------------------	----------	----------

<sup>1</sup> The ground floor finish level of buildings facing a public ROW must be 12 inches above grade, unless otherwise adjusted to comply with ADA.

Height limits do not apply to chimneys, architectural features, parapets, solar energy systems, or necessary mechanical equipment, provided that such features are limited to the minimum height necessary for their proper functioning.

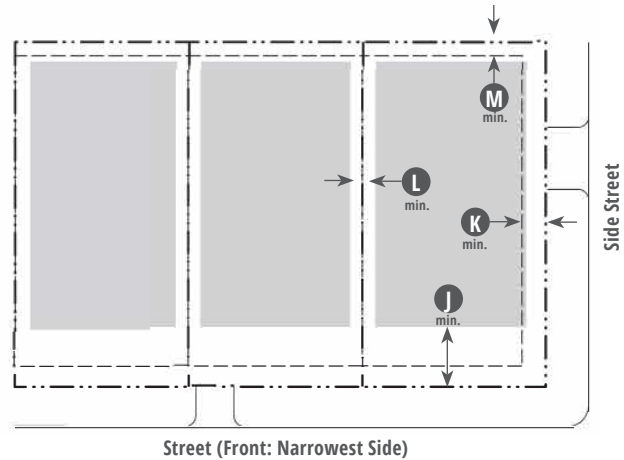
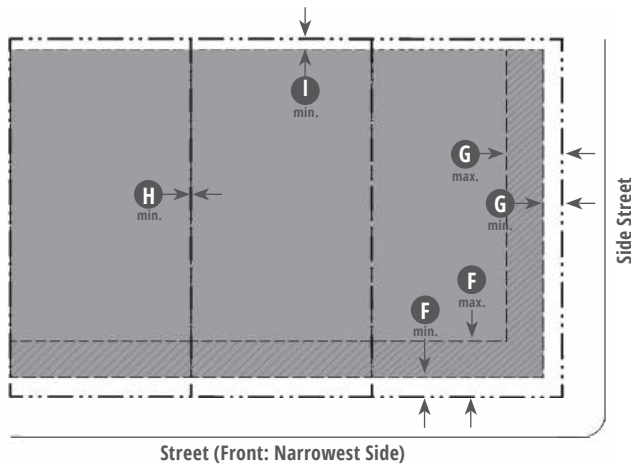

**Key**

- - - - ROW / Lot Line
- - - - Building Setback Line
- Buildable Area
- ▨ Facade Zone

**E. Building Placement**

**Setback (Distance from ROW / Lot Line)**

<b>Front (Facade Zone)</b>		F
Main Building <sup>1, 2</sup>	6' min.; 24' max.	
Accessory Structure(s)	26' min.	
<b>Street Side (Facade Zone)</b>		G
Main Building <sup>1</sup>	6' min.; 24' max.	
Accessory Structure(s)	6' min.	
<b>Side</b>		H
Main Building	0' min.	
Accessory Structure(s)	0' min.	
<b>Rear</b>		I
Main Building and Accessory Structure(s)	3' min.	

<sup>1</sup> Or average front setback of adjacent lots, whichever is less. For corner lots, average of minimum required and front setback of adjacent lot, whichever is less.

<sup>2</sup> A larger setback may be required to accommodate required frontage or other planned improvements.

**Building within Facade Zone (Percent of Net Lot Width)**

Front <sup>3</sup>	60% min.
Street Side	40% min.

<sup>3</sup> Required only when facing a public ROW

**Miscellaneous**

Building facade must be parallel to ROW/Lot Line.

Minimum one primary pedestrian entrance from primary street located within front facade zone.

**Key**

- - - - ROW / Lot Line
- - - - Building Setback Line
- Parking Area

**F. Parking and Driveways**

**Parking Requirements**

See [Section 3.2.050 \(Parking and Loading\)](#)

**Parking Location (Distance from ROW / Lot Line)**

Front Setback	30' min.	J
Street Side Setback	5' min.	K
Side Setback	5' min.	L
Rear Setback	5' min.	M



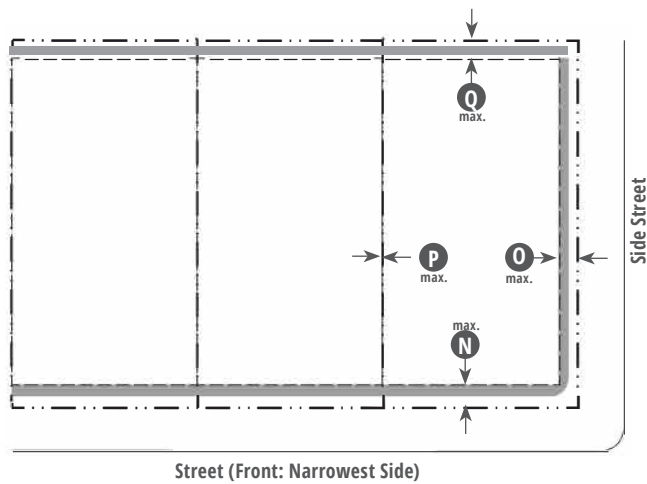

**Key**

- - - - ROW / Lot Line
- Encroachment Area
- — — Building Setback Line

**G. Projections into Required Yards**

Encroachment Type	N	O	P	Q
	Front	St. Side	Side	Rear
Frontage <sup>1</sup>	3' max.	3' max.	—	—
Steps or Ramp to Building Entrance	4' max.	3' max.	—	—
Architectural Features	3' max.	3' max.	—	3' max.

Encroachments at grade are not allowed within a street ROW, alley ROW, or across a lot line.

<sup>1</sup> See Division 3.3 (Specific to Frontage Types) for further refinement of the allowed encroachments for frontage elements.

**H. Frontages**

Private Frontage Type	Front	St. Side	Standards
Front Yard	A	A	3.4.050
Porch: Projecting	A	A	3.4.060
Porch: Engaged	A	A	3.4.070
Stoop	A	A	3.4.080
Forecourt	A	A	3.4.090
Dooryard	A	A	3.4.100
Maker Shopfront	-	A	3.4.110
Shopfront	A	A	3.4.120
Terrace	A	A	3.4.130

**Miscellaneous**

Corner Lots must have private frontage located within the Front and Street Side Facade Zone as required in Subsection E.

First story facades for non-residential uses and common areas for residential, must provide minimum 30% glazing with clear glass. See Division 3.3 (Specific to Frontage Types) for further refinement of the glazing requirements by frontage type.

**Key** A = Allowed — = Not Allowed

# Mission Boulevard - Neighborhood Node

## 2.2.050 Mission Boulevard - Neighborhood Node (MB-NN)



### A. Intent

A vibrant, urban neighborhood-serving node supporting mixed-use infill development to provide a range of commercial, retail, entertainment, civic, and moderate intensity residential uses in a more compact urban setting.

### B. Density

Minimum <sup>1</sup>	17.5 du/ac
Maximum	35 du/ac
	65 du/ac with Major Site Plan Review

*General note: The image above is intended to provide a brief overview of this zone and is illustrative only.*

*<sup>1</sup> Reduction in minimum density allowed subject to Major Site Plan Review.*

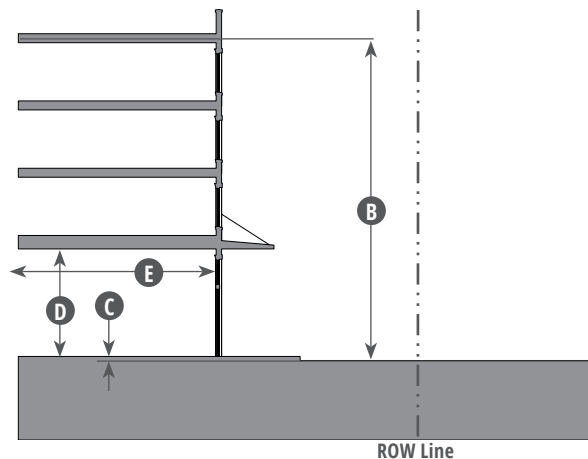
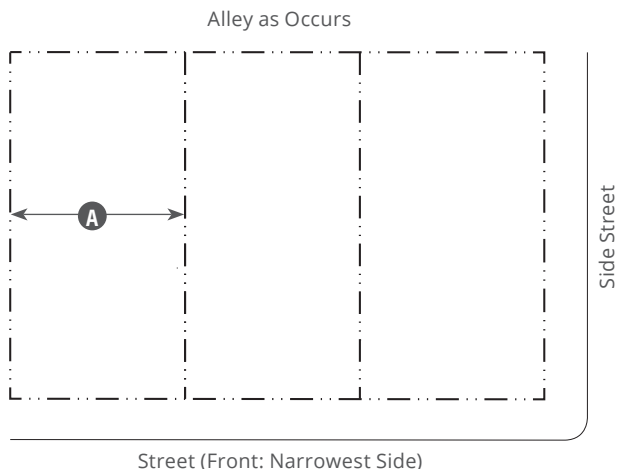

**Key**

--- ROW / Lot Line

**C. Lot Occupation**

Lot Width	18' min.	<b>A</b>
Lot Coverage	80% max.	
Landscaping	10% of lot area, min.	
Open Space	100 sf min. per unit <sup>1</sup>	

<sup>1</sup> Minimum 50 sf must be provided as private usable open space for minimum 50% of the units and minimum 50 sf per unit must be provided as common usable open space. The remaining open space requirement may be met by a combination of private or common usable open space.

**Key**

--- ROW Line

**D. Building Form**

<b>Height</b>		
<b>Main Building</b>		<b>B</b>
Stories	4 max., 5 max. with Major Site Plan Review	
Overall	57' max., 79 max. with Major Site Plan Review	

<b>Accessory Structure(s)</b>		
Stories	2 max.	

<b>Ground Floor Finish Level</b>		<b>C</b>
Residential	12" min. <sup>1</sup>	
Non-Residential	3' max.	

<b>Ground Floor Ceiling</b>		<b>D</b>
Non-Residential	14' min.	

**Other**

<b>Accessory Structure(s)</b>		
Square Feet	440 max.	

<b>Building Depth, Ground-Floor</b>	30' min.	<b>E</b>
-------------------------------------	----------	----------

<sup>1</sup> The ground floor finish level of buildings facing a public ROW must be 12 inches above grade, unless otherwise adjusted to comply with ADA.

Height limits do not apply to chimneys, architectural features, parapets, solar energy systems, or necessary mechanical equipment, provided that such features are limited to the minimum height necessary for their proper functioning.

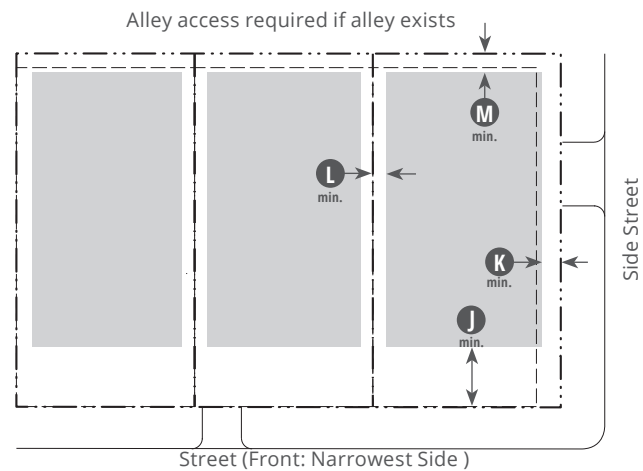
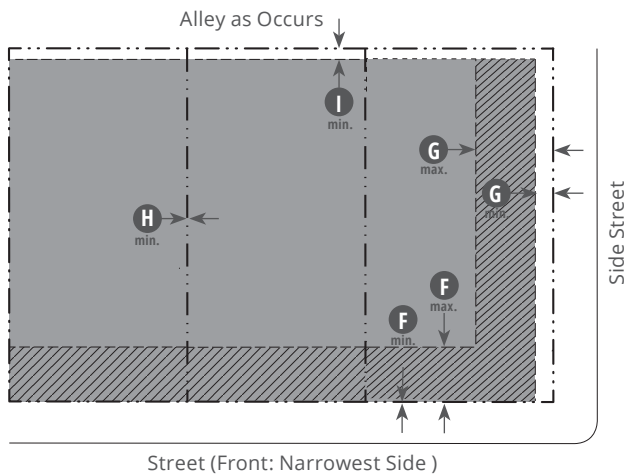

**Key**

- - - - ROW / Lot Line
- - - - Building Setback Line
- █ Buildable Area
- ▨ Facade Zone

**E. Building Placement**

**Setback (Distance from ROW / Lot Line)**

<b>Front (Facade Zone)</b>		<b>F</b>
Main Building <sup>1,2</sup>	0' min.; 24' max.	
Accessory Structure(s)	20' min.	
<b>Street Side (Facade Zone)</b>		<b>G</b>
Main Building <sup>1</sup>	6' min.; 24' max.	
Accessory Structure(s)	6' min.	
<b>Side</b>		<b>H</b>
Main Building	0' min.	
Accessory Structure(s)	0' min.	
<b>Rear</b>		<b>I</b>
Main Building and Accessory Structure(s)	3' min.	

<sup>1</sup> Or average front setback of adjacent lots, whichever is less. For corner lots, average of minimum required and front setback of adjacent lot, whichever is less.

<sup>2</sup> A larger setback may be required to accommodate required frontage or other planned improvements.

**Building within Facade Zone (Percent of Net Lot Width)**

Front <sup>3</sup>	60% min.
Street Side	40% min.

<sup>3</sup> Required only when facing a public ROW

**Miscellaneous**

Building facade must be parallel to ROW/Lot Line.

Minimum one primary pedestrian entrance from primary street located within front facade zone.

**Key**

- - - - ROW / Lot Line
- - - - Building Setback Line
- █ Parking Area

**F. Parking and Driveways**

**Parking Requirements**

See [Section 3.2.050 \(Parking and Loading\)](#)

**Parking Location (Distance from ROW / Lot Line)**

Front Setback	30' min.	<b>J</b>
Street Side Setback	5' min.	<b>K</b>
Side Setback	5' min.	<b>L</b>
Rear Setback	5' min.	<b>M</b>

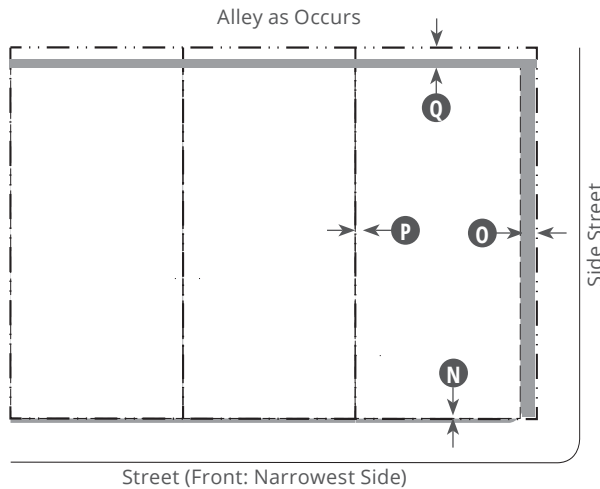

**Key**

- ROW / Lot Line
- Building Setback Line
- Encroachment Area

**G. Projections into Required Yards**

Encroachment Type	N	O	P	Q
	Front	St. Side	Side	Rear
Frontage <sup>1</sup>	May encroach up to the property line		—	—
Steps or Ramp to Building Entrance	May encroach up to the property line		—	—
Architectural Features	3' max.	3' max.	—	3' max.

Encroachments at grade are not allowed within a street ROW, alley ROW, or across a lot line.

<sup>1</sup> See Division 3.3 (Specific to Frontage Types) for further refinement of the allowed encroachments for frontage elements.

**H. Frontages**

Private Frontage Type	Front	St. Side	Standards
Porch: Projecting	A <sup>1</sup>	A	3.4.060
Porch: Engaged	A <sup>1</sup>	A	3.4.070
Stoop	A <sup>1</sup>	A	3.4.080
Forecourt	A	A	3.4.090
Dooryard	A	A	3.4.100
Maker Shopfront	-	A	3.4.110
Shopfront	A	A	3.4.120
Terrace	A	A	3.4.130
Gallery	A	A	3.4.140

<sup>1</sup> Not allowed facing Mission Boulevard.

**Miscellaneous**

Corner Lots must have private frontage located within the Front and Street Side Facade Zone as required in Subsection E.

First story facades for non-residential uses and common areas for residential, must provide minimum 30% glazing with clear glass. See Division 3.3 (Specific to Frontage Types) for further refinement of the glazing requirements by frontage type.

**Key** A = Allowed — = Not Allowed

# Mission Boulevard - Corridor Center

## 2.2.060 Mission Boulevard - Corridor Center (MB-CC)



### A. Intent

A transit-oriented mixed-use, urban center with high-intensity, residential and non-residential uses located within close proximity to BART, to facilitate access to BART by biking or walking.

### B. Density

Minimum <sup>1</sup>	35 du/ac
TOD Overlay 1	75 du/ac
TOD Overlay 2	40 du/ac
Maximum	55 du/ac , 75 du/ac with Major Site Plan Review
TOD Overlay 1	100 du/ac
TOD Overlay 2	65 du/ac, 100 du/ac with Major Site Plan Review

*General note: The image above is intended to provide a brief overview of this zone and is illustrative only.*

*<sup>1</sup> Reduction in minimum density allowed subject to Major Site Plan Review.*

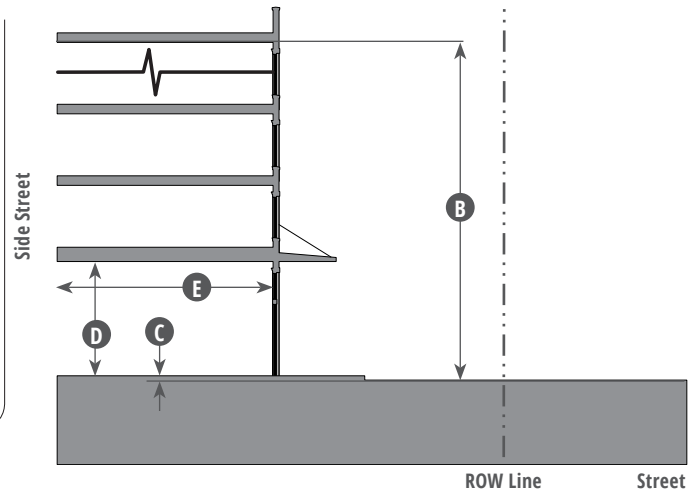
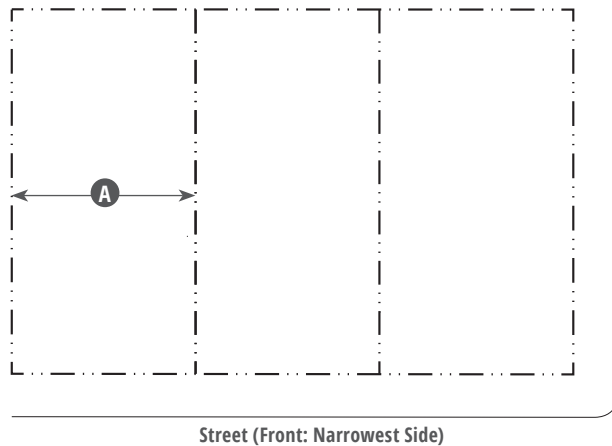

**Key**

--- ROW / Lot Line

**C. Lot Occupation**

Lot Width	18' min.	<b>A</b>
Lot Coverage	90% max.	
Landscaping	10% of lot area, min.	
Open Space	100 sf min. per unit <sup>1</sup>	

<sup>1</sup> Minimum 50 sf must be provided as private usable open space for minimum 50% of the units and minimum 50 sf per unit must be provided as common usable open space. The remaining open space requirement may be met by a combination of private or common usable open space.

**Key**

--- ROW Line

↖ Additional Stories in Place

**D. Building Form**

<b>Height</b>		<b>B</b>
<b>Main Building</b>	Stories	5 max., 6 max. with Major Site Plan Review
	Overall	68' max., 79' max. with Major Site Plan Review

<b>Accessory Structure(s)</b>	Stories	2 max.
-------------------------------	---------	--------

<b>Ground Floor Finish Level</b>		<b>C</b>
	Residential	12" min. <sup>1</sup>
	Non-Residential	3' max.

<b>Ground Floor Ceiling</b>		<b>D</b>
	Non-Residential	14' min.

**Other**

<b>Accessory Structure(s)</b>	Square Feet	440 max.
-------------------------------	-------------	----------

<b>Building Depth, Ground-Floor</b>		30' min.	<b>E</b>
-------------------------------------	--	----------	----------

<sup>1</sup> The ground floor finish level of buildings facing a public ROW must be 12 inches above grade, unless otherwise adjusted to comply with ADA.

Height limits do not apply to chimneys, architectural features, parapets, solar energy systems, or necessary mechanical equipment, provided that such features are limited to the minimum height necessary for their proper functioning.

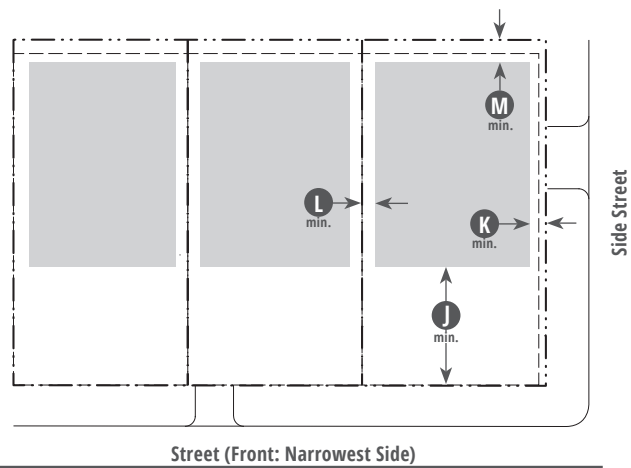
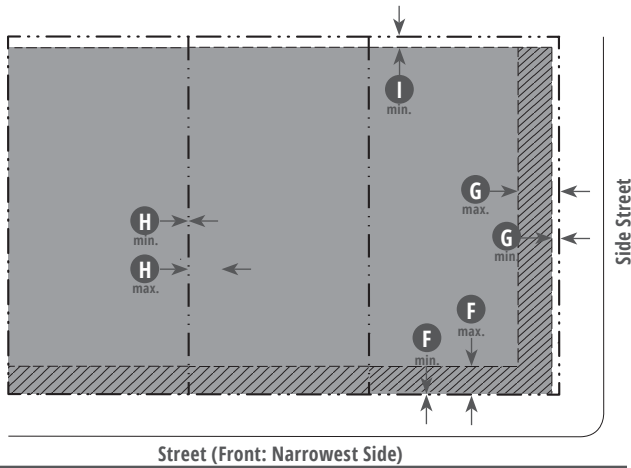

**Key**

- - - - ROW / Lot Line
- - - - Building Setback Line
- █ Buildable Area
- ▨ Facade Zone

**E. Building Placement**

**Setback (Distance from ROW / Lot Line)**

**Front (Facade Zone)**

Main Building <sup>1, 2</sup>	0' min.; 12' max.	<b>F</b>
Accessory Structure(s)	Must be within 40' from rear lot line	

**Street Side (Facade Zone)**

Main Building <sup>1</sup>	2' min.; 12' max.	<b>G</b>
Accessory Structure(s)	2' min.	

**Side**

Main Building	0' min. 12' max.	<b>H</b>
Accessory Structure(s)	0' min.	

**Rear**

Main Building and Accessory Structure(s)	3' min.	<b>I</b>
--	---------	----------

<sup>1</sup> Or average front setback of adjacent lots, whichever is less. For corner lots, average of minimum required and front setback of adjacent lot, whichever is less.

<sup>2</sup> A larger setback may be required to accommodate required frontage or other planned improvements.

**Building within Facade Zone (Percent of Net Lot Width)**

Front <sup>3</sup>	80% min.
Street Side	60% min.

<sup>3</sup> Required only when facing a public ROW. May be reduced as needed to comply with minimum fire access requirements.

**Key**

- - - - ROW / Lot Line
- - - - Building Setback Line
- █ Parking Area

**E. Building Placement (continued)**

**Miscellaneous**

Building facade must be parallel to ROW/Lot Line.

Minimum one primary pedestrian entrance from primary street located within front facade zone.

**F. Parking and Driveways**

**Parking Requirements**

See [Section 3.2.050 \(Parking and Loading\)](#)

**Parking Location (Distance from ROW / Lot Line)**

Front Setback	40' min.	<b>J</b>
Street Side Setback	5' min.	<b>K</b>
Side Setback	5' min.	<b>L</b>
Rear Setback	5' min.	<b>M</b>

**Miscellaneous**

Pedestrian exits from all parking lots, garages, and Parking Structures shall be directly to a public ROW (i.e., not directly into a building) except underground levels which may be exited by pedestrians directly into a building.



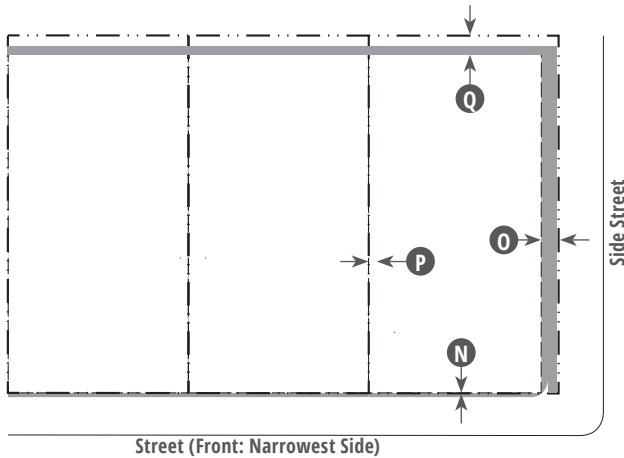

**Key**

- ROW / Lot Line
- Building Setback Line
- Encroachment Area

**G. Projections into Required Yards**

Encroachment Type	N	O	P	Q
	Front	St. Side	Side	Rear
Frontage <sup>1</sup>	May encroach up to the property line		—	—
Steps or Ramp to Building Entrance	May encroach up to the property line		—	—
Architectural Features	3' max.	3' max.	—	3' max.

Encroachments at grade are not allowed within a street ROW, alley ROW, or across a lot line.

<sup>1</sup> See Division 3.3 (Specific to Frontage Types) for further refinement of the allowed encroachments for frontage elements.

**H. Frontages**

Private Frontage Type	Front	St. Side	Standards
Stoop	A	A	3.4.080
Forecourt	A	A	3.4.090
Dooryard	A	A	3.4.100
Maker Shopfront	-	A	3.4.110
Shopfront	A	A	3.4.120
Terrace	A	A	3.4.130
Gallery	A	A	3.4.140

**Miscellaneous**

Corner Lots must have private frontage located within the Front and Street Side Facade Zone as required in Subsection E.

First story facades for non-residential uses and common areas for residential, must provide minimum 30% glazing with clear glass. See Division 3.3 (Specific to Frontage Types) for further refinement of the glazing requirements by frontage type.

**Key** A = Allowed — = Not Allowed

*This page intentionally left blank*

## Division 2.3: Use Tables

### Sections

2.3.010 Allowed Land Uses and Permit Requirements. . . . . 2-23

### 2.3.010 Allowed Land Uses and Permit Requirements

- A. Table 2.3.010.A (Allowed Uses and Permit Requirements), sets the land use regulations for the Mission Boulevard Corridor Zones by letter designation as follows unless a use or activity is prohibited or subject to a higher level of permit pursuant to other parts of this Code or other applicable regulations:
  - “P” designates permitted uses.
  - “A” designates uses that are permitted after review and approval of an Administrative Use Permit.
  - “C” designates uses that are permitted after review and approval of a Conditional Use Permit.
  - “P/C” designates uses that are permitted or permitted after review and approval of a Conditional Use Permit under certain circumstances.
  - “-” designates uses that are not allowed.
- B. A project which includes two or more categories of land use in the same building or on the same site is subject to the highest permit level required for any individual use or single component of the project.
- C. Land uses are defined in [Section 10-1.3500 \(Definitions\)](#), of the Hayward Zoning Code. In cases where a specific land use or activity is not defined, the Planning Director may make a determination in compliance with [Section 10-1.2835 \(District Uses Not Specified\)](#) of the Hayward Zoning Code.

Table 2.3.010.A: Allowed Uses and Permit Requirements					
Land Use	MB-CN	MB-NN	MB-CC	MB-CS <sup>1</sup>	Additional Regulations
<b>Residential</b>					
Emergency Homeless Shelter	P/C <sup>2,3</sup>	P/C <sup>2,3</sup>	-	-	Limited to parcels abutting Mission Boulevard
Live-Work	P/C <sup>2,3</sup>	P/C <sup>2,3</sup>	-	-	
Multiple Family Dwelling(s)	P/C <sup>2,3</sup>	P/C <sup>2,3</sup>	P/C <sup>2,3</sup>	-	
Single-Family Dwelling <sup>4</sup>	P	P	P	-	
Single Room Occupancy (SRO)	-	-	C	-	
Townhouse Dwelling	P/C <sup>2,3</sup>	P/C <sup>2,3</sup>	P/C <sup>2,3</sup>	-	
<b>Lodging</b>					
Hotel	A	A	A	-	
<b>Office</b>					
Architectural Service, Drafting Service, Engineering Service	P	P	P	-	
Banks <sup>5</sup>	P	P	P	-	

<b>Table 2.3.010.A: Allowed Uses and Permit Requirements</b>					
<b>Land Use</b>	<b>MB-CN</b>	<b>MB-NN</b>	<b>MB-CC</b>	<b>MB-CS <sup>1</sup></b>	<b>Additional Regulations</b>
Financial Institutions <sup>5</sup>	P	P	P	-	
Medical/Dental Laboratory	A	A	A	C	
Office	P	P	P	-	
<b>Retail/Commercial</b>					
Alcohol Sales	Refer to Section 10-1.2750 et seq. of the Hayward Zoning Code for Alcoholic Beverage Outlets Regulations				
Appliance Repair Shop	P	P	A	-	
Appliance Store	P	P	A	-	
Bar, Cocktail Lounge	C	C	C	-	
Carpet/Draper Store	P	P	A	-	
Check Cashing Store	-	-	-	-	
Convenience Market	P	P	P	-	If use includes alcohol sales, see also Section 10-1.2750 et seq. of the Hayward Zoning Code for Alcoholic Beverage Outlets Regulations
Copying or Reproduction Facility	P	P	P	-	
Equipment Rental Service	A	A	A	-	
Furniture Store	P	P	A	-	
Health Club	A	A	A	C	
Kennel	A	A	A	-	
Large Motion Picture Theater	C	C	C	C	
Liquor Store	-	-	-	-	
Live Performance Theater	A	A	A	A	
Massage Parlor	-	-	-	-	
Media Production	A	A	P	-	
Newspaper Printing Facility	A	A	P	-	
Nursery (Plants)	P	P	P	-	
Pawn Shop	-	-	-	-	
Payday Loan Facilities	-	-	-	-	
Personal Services	P	P	P	-	
Physical Fitness Studio	P	P	P	C	
Publishing Facility	A	A	P	-	
Recreational Facility	A	A	A	C	
Small Recycling Collection Facilities/Recycling Collection Area	A	A	A	-	See Hayward Zoning Code Subsection 10-1.2735.j, Small Recycling Collection Facilities and Unattended Collection Boxes

<b>Table 2.3.010.A: Allowed Uses and Permit Requirements</b>					
<b>Land Use</b>	<b>MB-CN</b>	<b>MB-NN</b>	<b>MB-CC</b>	<b>MB-CS<sup>1</sup></b>	<b>Additional Regulations</b>
Restaurant, Including Micro-Breweries as accessory to the Restaurant and standalone Catering Facilities.	P	P	P	-	See Hayward Zoning Code Section 10-1.2750 et seq. for alcohol regulations  See Section 3.4.040.F.4 and 5 for outdoor seating requirements
Retail	P	P	P	C	
Small Motion Picture Theater	A	A	A	C	
Tattoo Parlor	-	-	-	-	
Tobacco Retail Sales Establishment	-	-	-	-	
<b>Civic</b>					
Cultural or Meeting Facilities	A	A	A	C	
Public Park/Public Gathering	P	P	P	P	
Parking Lots and Structures	A	A	A	C	
Public Agency Facilities	P	P	P	P	
Religious Facility	A	A	A	C	
<b>Other: Agriculture</b>					
Community Garden	P	P	P	P	
<b>Other: Automotive</b>					
Automobile Repair (Minor)	A	A	A	-	
Automobile Repair (Major)	C	C	C	-	
Automobile Sales <sup>6</sup>	P/C	P/C	P/C	-	
Drive-In Establishment	C	C	C	-	
Automobile Service Station	C	C	C	-	
Taxi Company	A	A	A	-	
<b>Other: Civil Support</b>					
Hospital	A	A	A	C	
Mortuary	A	A	A	C	
<b>Other: Education</b>					
Day Care Center	P	P	P	C	
Day Care Home	P	P	-	-	
Educational Facilities ≤ 2,000 GFA	P	P	P	C	
Educational Facilities > 2,000 GFA	A	A	A	C	
Industrial/Vocational Trade School	A	A	A	C	
<b>Other: Light Industrial</b>					
Micro-Brewery	C	C	C	-	See Hayward Zoning Code Section 10-1.2750 et seq. for alcohol regulations
Custom Manufacturing	P	P	P	-	

<b>Table 2.3.010.A: Allowed Uses and Permit Requirements</b>					
<b>Land Use</b>	<b>MB-CN</b>	<b>MB-NN</b>	<b>MB-CC</b>	<b>MB-CS <sup>1</sup></b>	<b>Additional Regulations</b>
Distillery	C	C	C	-	See Hayward Zoning Code Section 10-1.2750 et seq. for alcohol regulations
Light Manufacturing	AUP	AUP	-	-	
Research and Development	P	P	-	-	
<b>Other Use</b>					
Animal Hospital	A	A	A	-	
Commercial Amusement Facility	A	A	A	-	
Food Vendor	P	P	P	-	See Hayward Zoning Code Subsection 10-1.2735.m, Food Vendor Permit
Temporary Uses	See Section 3.5.020, Temporary Uses				
<b>Specific Limitations:</b>					
<ol style="list-style-type: none"> <li>1. When the MB-CS Zone is applied to privately owned property, the use and building existing at the time this Code comes into effect may continue until the site is redeveloped or becomes under public ownership.</li> <li>2. For properties located within Commercial Overlay Zone 1, as shown in the Regulating Plan, commercial uses are required on the ground floor along roadway frontages. Uses associated with the residential use, such as leasing office, community space, amenities, etc., are allowed on the ground floor.</li> <li>3. For properties located within Commercial Overlay Zone 2, as shown in the Regulating Plan, residential units are only allowed along the primary street frontage with a conditional use permit.</li> <li>4. Single-family dwelling permitted if the lot/parcel has an existing, permitted single-family dwelling that was constructed prior to the effective date of this Code. No new detached single-family dwellings are allowed.</li> <li>5. Does not include check cashing, pay loans, or auto title loans.</li> <li>6. An Administrative Use Permit is required for automobile sales uses south of Harder Road.</li> </ol>					

# Article 3: Supplemental to Zones

<b>Division 3.1 Purpose and Intent</b>		<b>3-3</b>
3.1.010	Purpose and Intent .....	3-3
3.1.020	Applicability.....	3-3
<b>Division 3.2: General Standards</b>		<b>3-5</b>
3.2.010	Architectural Standards .....	3-5
3.2.020	Mechanical and Electrical Equipment.....	3-6
3.2.030	Exterior and Parking Lot Lighting .....	3-6
3.2.040	Fences and Walls .....	3-6
3.2.050	Parking and loading.....	3-7
3.2.060	Landscaping .....	3-9
3.2.070	Air Quality Mitigation Measures .....	3-10
3.2.080	Visitability Standards.....	3-11
3.2.090	Sustainability Plan .....	3-11
<b>Division 3.3 Specific to Frontage Types</b>		<b>3-13</b>
3.3.010	Purpose .....	3-13
3.3.020	Applicability.....	3-13
3.3.030	Overview .....	3-14
3.3.040	General to Private Frontages .....	3-14
3.3.050	Front Yard .....	3-15
3.3.060	Porch: Projecting .....	3-16
3.3.070	Porch: Engaged .....	3-17
3.3.080	Stoop .....	3-18
3.3.090	Forecourt.....	3-19
3.3.100	Dooryard .....	3-20
3.3.110	Maker Shopfront.....	3-21
3.3.120	Shopfront.....	3-22
3.3.130	Terrace .....	3-23
3.3.140	Gallery .....	3-24

<b>Division 3.4 Specific to Civic Spaces</b>		<b>3-25</b>
3.4.010	Purpose .....	3-25
3.4.020	Applicability .....	3-25
3.4.030	Overview .....	3-26
3.4.040	General to All Civic Spaces .....	3-26
3.4.050	Greenway .....	3-28
3.4.060	Green .....	3-29
3.4.070	Square .....	3-30
3.4.080	Pocket Plaza .....	3-31
3.4.090	Playground .....	3-32
<b>Division 3.5 Specific to Uses</b>		<b>3-33</b>
3.5.010	Telecommunication Facilities .....	3-33
3.5.020	Temporary Uses .....	3-34
<b>Division 3.6: Standards for Large Sites</b>		<b>3-39</b>
3.6.010	Purpose and Applicability .....	3-39
3.6.020	Major Site Plan Required .....	3-39
3.6.030	Development Requirements .....	3-40



## Division 3.1 Purpose and Intent

---

### Sections

3.1.010	Purpose and Intent . . . . .	3-3
3.1.020	Applicability . . . . .	3-3

---

### 3.1.010 Purpose and Intent

This Article sets forth supplemental standards for the development of each frontage type, civic space type, and related general standards within zones. These standards supplement the standards for each zone.

---

### 3.1.020 Applicability

- A. The standards in this Article apply to all proposed development within Mission Boulevard Corridor Code Area and must be considered in combination with the standards for the applicable zone in [Division 2.2 \(Mission Boulevard Corridor Zones\)](#).
- B. In the event of any conflict between the standards of this Article and the standards in another Article of this Chapter or any standard in the Municipal Code, the standards in this Article supersede, unless stated otherwise.

*This page intentionally left blank*

## Division 3.2: General Standards

---

### Sections

3.2.010	Architectural Standards . . . . .	3-5
3.2.020	Mechanical and Electrical Equipment . . . . .	3-6
3.2.030	Exterior and Parking Lot Lighting . . . . .	3-6
3.2.040	Fences and Walls . . . . .	3-6
3.2.050	Parking and loading . . . . .	3-7
3.2.060	Landscaping . . . . .	3-9
3.2.070	Air Quality Mitigation Measures . . . . .	3-10
3.2.080	Visitability Standards . . . . .	3-11
3.2.090	Sustainability Plan . . . . .	3-11

---

### 3.2.010 Architectural Standards

- A. **Facade Articulation.** Projects shall be designed consistent with the following design objectives:
1. Street facing elevations shall be articulated through variation in wall plane, variation in wall height, and roofs located at different levels in order to enhance visual interest of the elevation.
  2. Massing elements shall be properly scaled and in proportion to one another in order to provide a balance between horizontal and vertical emphasis.
  3. Minimize blank wall planes on all elevations through the use of wall plane variation, trim or reveals, entry and window openings, and/or varying colors and materials.
- B. **Materials.**
1. Building wall materials may be horizontally combined on each facade with the visually heavier/denser material located below the lighter material.
  2. Galleries, balconies, and porches shall be of a material compatible with the architectural materials of the main building.
- C. **Openings.** All openings, including porches, galleries, and windows, with the exception of shopfronts, shall be square or vertical in proportion.
- D. **Roofs.** Flat roofs shall be enclosed by parapets a minimum of 42 inches high, or as required to conceal mechanical equipment to the satisfaction of the Review Authority.

---

### 3.2.020 Mechanical and Electrical Equipment

All exterior mechanical and electrical equipment shall be screened or incorporated into the design of buildings so as not to be visible from public rights-of-way. Equipment to be screened includes, but is not limited to, all roof-mounted equipment, air conditioners, emergency generators, heaters, utility meters, cable equipment, telephone entry boxes, backflow preventions, irrigation control valves, electrical transformers, pull boxes, and all ducting for air conditioning, heating, and blower systems. Screening materials shall be consistent with the exterior colors and materials of the building. Exceptions may be granted by the Planning Director or other approving authority where screening is infeasible due to existing development or health and safety or utility requirements.

---

### 3.2.030 Exterior and Parking Lot Lighting

- A. Exterior lighting and parking lot lighting shall be provided and be designed by a qualified lighting designer and erected and maintained so that light is confined to the property and will not cast direct light or glare upon adjacent properties or public rights-of-way. Such lighting shall also be designed such that it is decorative and in keeping with the design of the development.
- B. **Safety and Security.** Common areas, parking lots, entries, and areas adjacent to walkways, bike paths, and other connections shall be well lit and provide for visual surveillance, especially at points of entry. Avoid dense hedges, dark corners, and other elements or site layouts that can obstruct visibility or result single point of entry and exit.

---

### 3.2.040 Fences and Walls

- A. **Height.** Fences and walls may be constructed to a height of six (6) feet in any side or rear setback, and to a height of four (4) feet in any portion of a front or street side setback, except that where the rear or side setback is contiguous to the BART tracks, a flood control channel, or parking lot, a maximum 8-foot-high fence or wall is permitted.
- B. **Materials.**
  - 1. Fences and walls in the front and street side setbacks shall be painted, mural-covered, vine-covered, or of a high-quality or decorative material compatible with the architectural materials of the main building.
  - 2. Anti-graffiti coating shall be required for all solid walls, decorative or otherwise, unless covered with a mural or vines.
  - 3. Other fences may be of wood board or decorative metal.
  - 4. Barb wire, razor wire, or electric fences are prohibited.
  - 5. Fences and walls above 3 feet are prohibited in the Vision Triangle area.
- C. **Fence Types.** [Table A \(Fences and Walls by Zone\)](#) shows five common types of fences and walls and their appropriateness within the Mission Boulevard Corridor Zones. Only these fences and wall types shall be used in any portion of a front or side yard unless an alternative type, complementary to the design and character of the development, is approved by the Planning Director.

Fence Type	MB-CN	MB-NN	MB-CC	Notes
Chain Link Fence	X	X	X	Allowed only within side and rear yard areas that do not front private driveways or public roadways.
Wood Picket Fence	X	X	-	
Iron Picket Fence	X	X	X	
Metal Fence on Concrete Base	X	X	X	The concrete base should be 18"-36" in height.
Brick and Iron Fence	X	X	X	Although brick only is named, other materials such as stone, slate, etc. are also acceptable, with a tie-in to the building material
Brick Wall	X	X	X	

### 3.2.050 Parking and loading

The parking and loading provisions of Article 2 (Off-Street Parking Regulations) of the Hayward Zoning Code apply except as provided below.

#### A. Required Ratio of Parking Spaces.

1. There is no requirement for a minimum number of off-street automobile parking spaces.
2. There is a maximum of two (2) off-street parking spaces per residential unit allowed except within one-half mile of the Hayward and South Hayward BART Stations where there is a maximum of one (1) off-street automobile parking space per residential unit allowed. The Review Authority may approve additional residential parking after making all the following findings:
  - a. The request is consistent with the goals and policies of the Hayward General Plan, the Mission Boulevard Form Based Code; and any other adopted policies related to parking and the multi-modal network.
  - b. The request is supported by a quantitative justification from the applicant that the demand for the additional parking spaces exists and providing additional parking spaces is warranted; and
  - c. The additional parking will not impede bicycle and pedestrian circulation and safety.

#### B. Tandem Parking.

1. Tandem parking may be provided for residential uses when spaces are assigned to the same dwelling unit.
2. Tandem Parking may be provided for nonresidential uses when a valet/attendant is on duty during the hours when the business is open.

- C. **Landscaped Planter.** A landscaped planter at least five feet wide shall be provided between any surface parking area and any property line for the length of the parking area.

D. **Bicycle Parking.** Bicycle parking shall be provided and located in accordance with the most recent version of Section 5.106.4 of the California Green Building Standards Code (CalGreen) and the following.

1. **Bicycle Parking Requirements.** Table D, **Bicycle Parking Requirements**, lists the amount of short-term and long-term bicycle parking to be provided.

<b>Table 3.2.050.B: Bicycle Parking Requirements</b>			
<b>Use Type</b>	<b>MB-CN</b>	<b>MB-NN</b>	<b>MB-CC</b>
<b>Short-Term Parking</b>			
Residential	1 space per 10 units, minimum 2 spaces	1 space per 10 units, minimum 2 spaces	1 space per 10 units, minimum 2 spaces
Office	1 space per 15,000 square feet, minimum 2 spaces	1 space per 15,000 square feet, minimum 2 spaces	1 space per 15,000 square feet, minimum 2 spaces
Retail	1 space per 5,000 square feet, minimum 2 spaces	1 space per 5,000 square feet, minimum 2 spaces	1 space per 5,000 square feet, minimum 2 spaces
Civic, Non-Assembly	1 space per 15,000 square feet, minimum 2 spaces	1 space per 15,000 square feet, minimum 2 spaces	1 space per 15,000 square feet, minimum 2 spaces
Civic, Assembly	1 space per 15,000 square feet, minimum 2 spaces	1 space per 15,000 square feet, minimum 2 spaces	1 space per 15,000 square feet, minimum 2 spaces
School, University	1 space per 10 students, minimum 2 spaces	1 space per 10 students, minimum 2 spaces	1 space per 20 students, minimum 2 spaces
<b>Long-Term Parking</b>			
Residential	1 space per 4 units, minimum 2 spaces	1 space per 4 units, minimum 2 spaces	1 space per 4 units, minimum 2 spaces
Office	1 space per 10,000 square feet, minimum 2 spaces	1 space per 10,000 square feet, minimum 2 spaces	1 space per 10,000 square feet, minimum 2 spaces
Retail	1 space per 10,000 square feet, minimum 2 spaces	1 space per 10,000 square feet, minimum 2 spaces	1 space per 10,000 square feet, minimum 2 spaces
Civic, Non-Assembly	1 space per 15 employees, minimum 2 spaces	1 space per 15 employees, minimum 2 spaces	1 space per 15 employees, minimum 2 spaces
Civic, Assembly	1 space per 15 employees, minimum 2 spaces	1 space per 15 employees, minimum 2 spaces	1 space per 15 employees, minimum 2 spaces
School, University	1 space per 10 students, minimum 2 spaces	1 space per 10 students, minimum 2 spaces	1 space per 10 students, minimum 2 spaces

2. **Bicycle Parking Standards.** Bicycle spaces must be provided in compliance with the following standards:
  - a. Long-term bicycle parking must consist of one of the following:
    - (i) Covered, lockable enclosures with permanently anchored racks for bicycles;
    - (ii) Lockable bicycle rooms with permanently anchored racks;
    - (iii) Lockable, permanently anchored bicycle lockers; or

- (iv) For residential uses, private garages or other private, lockable storage space accessible from the outside.
  - (v) Lockable enclosure shall be located in compliance with CPTED principles.
  - b. Short-term bicycle parking must include racks to which the bicycle can be locked;
  - c. Lockers and racks must be securely anchored to the pavement or a structure;
  - d. Racks must be designed and installed to allow two points of contact with the frame and allow the frame and one or both wheels to be secured;
  - e. Areas containing bicycle spaces must be surfaced with impervious surfaces such as concrete or pavers. Pervious pavements or gravel may be used where appropriate as determined by the Planning Director or City Engineer;
  - f. When located within a parking area, curbs, fences, planter areas, bumpers, or similar barriers must be installed and maintained for the mutual protection of bikes, motor vehicles and pedestrians, unless determined by the Planning Director to be unnecessary; and
  - g. Bicycle parking must be placed in a convenient, highly-visible, active, and well-lit location within 100 feet of the entrance of the use the bicycle parking is serving. At the discretion of the Planning Director, required bicycle parking may be provided within the public right-of-way.
3. **Bicycle Parking Space Dimensions.** All bicycle parking racks must meet the following minimum dimensions:
- a. Each bicycle parking space must include a minimum area of 72 inches in length and 24 inches in width that is clear of obstructions;
  - b. No part of the rack may be located closer than 30 inches to a wall or other obstruction;
  - c. The front or back of the rack must be located no less than 48 inches from a sidewalk or pedestrian way; and
  - d. A minimum of 30 inches must be provided between adjoining racks.
4. **Bicycle Parking Modifications.** If providing required bicycle parking spaces on-site is infeasible due to space or site specific constraints, the Planning Director may allow placement of bicycle parking off-site at a nearby location, which may include the public right-of-way.
5. **Location.** Bicycle racks and/or bicycle lockers shall be adjacent to building entries where they are clearly visible in order to enhance safety and security.

---

### 3.2.060 Landscaping

#### A. MB-CN and MB-NN Zones.

- 1. All setbacks shall be landscaped except for permitted driveways and walkways.
- 2. A minimum of one tree per 30 feet of frontage shall be planted within the front setback, (e.g. A lot with 120 feet of frontage requires 4 trees total). Trees should be a single species to match the species of street trees along the project frontage.

Portions of buildings facing a public street shall have one or more landscaped areas with a minimum five-foot-wide landscaped area along a minimum 50 percent of the building face.

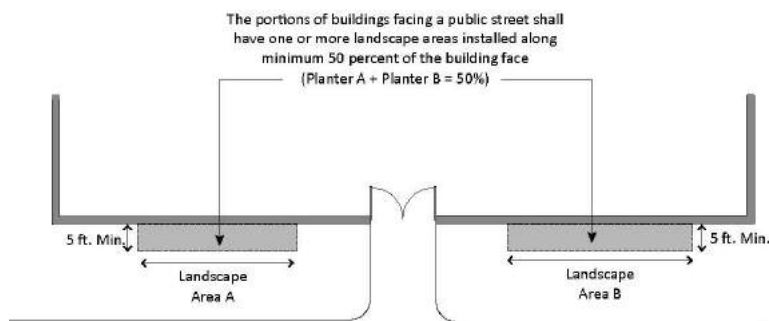

- B. **MB-CC Zone.** All setbacks shall be landscaped except for permitted driveways, walkways, or areas paved to match the pavement of the adjacent public frontage.

### 3.2.070 Air Quality Mitigation Measures

- A. **Applicability.** The provisions of this Section apply to development within 500 feet of Mission Boulevard, Jackson Street, or any stationary source which exceeds the applicable BAAQMD individual source or cumulative threshold.
- B. **Requirements.** All development projects that will be occupied by sensitive receptors shall incorporate indoor and outdoor air quality features pursuant to subsections C, Indoor Air Quality, and D, Outdoor Air Quality, below, or prepare a Health Risk Assessment (HRA) pursuant to subsection C.
1. Sensitive receptors include, but are not limited to, residences, schools and school yards, parks and play grounds, daycare centers, nursing homes, and medical facilities. Residences may include, but are not limited to, houses, apartments, and senior living complexes. Medical facilities may include, but are not limited to, hospitals, convalescent homes, and health clinics. Playgrounds may be, but are not limited to, play areas associated with parks or community centers.
- C. **Indoor Air Quality.**
1. Existing or new buildings to be occupied by sensitive receptors, shall include and maintain in good working order a central heating and ventilation (HVAC) system or other air intake system in the building, or in each individual unit, that meets or exceeds an efficiency standard of MERV 13 or equivalent. The HVAC system shall include installation of a high efficiency filter and/or carbon filter to filter particulates and other chemical matter from entering the building.
  2. Project applicants shall maintain, repair and/or replace HV system on an ongoing and as needed basis according to manufacturer specifications. For developments which are leased, sold or otherwise not maintained by the initial project developer, an operation and maintenance manual for the HVAC system shall be prepared. The manual shall include the operating instructions and the maintenance and replacement schedule. The Planning Director shall identify an appropriate filing location for the



manual, which may include, but is not limited to, the project conditions, covenants and restrictions (CC&Rs), County recorder, or City development permit file.

3. The HVAC system or other air intake system required above, shall be submitted to the Planning Director for review and action prior to the issuance of a demolition, grading, or building permit.

**D. Outdoor Air Quality.** To the maximum extent practicable, individual and common exterior open space, including playgrounds, patios, and decks, shall either be shielded from the source of air pollution by buildings or otherwise buffered to further reduce air pollution for project occupants.

**E. Health Risk Assessment.** As an alternative to the indoor and outdoor air quality requirements established in subsections A and B above, a Health Risk Assessment (HRA) may be prepared by a qualified air quality consultant in accordance with California Air Resources Board (CARB) and Office of Environmental Health and Hazard Assessment requirements.

1. The HRA shall demonstrate that indoor and outdoor air quality can be maintained within currently applicable health risk standards of the Bay Area Air Quality Management District.
2. The HRA shall be submitted to the Development Services Department for review and approval. The Development Services Department may require, at the applicant's sole expense, an independent review of the HRA by a qualified consultant.
3. If the HRA concludes that the air quality risks from nearby sources are at or below acceptable levels, then air quality mitigation measures are not required.
4. The applicant shall implement the approved HRA recommendations, if any.

---

### 3.2.080 Visitability Standards

There shall be provided at least one zero-step entrance to each building from an accessible path at the front, side, or rear of each building.

---

### 3.2.090 Sustainability Plan

All applications for new development or redevelopment of a site in the Code Area shall include a Sustainability Plan that incorporates best practices of sustainability for the proposed operations and site-specific improvements. The Plan may include, but not limited to, recommendations for energy conservation and efficiency, green infrastructure, water conservation, reductions in air emissions, use of toxic materials, and recycling.

*This page intentionally left blank*

## Division 3.3 Specific to Frontage Types

---

### Sections

3.3.010	Purpose .....	3-13
3.3.020	Applicability .....	3-13
3.3.030	Overview.....	3-14
3.3.040	General to Private Frontages .....	3-14
3.3.050	Front Yard.....	3-15
3.3.060	Porch: Projecting.....	3-16
3.3.070	Porch: Engaged .....	3-17
3.3.080	Stoop.....	3-18
3.3.090	Forecourt .....	3-19
3.3.100	Dooryard .....	3-20
3.3.110	Maker Shopfront.....	3-21
3.3.120	Shopfront .....	3-22
3.3.130	Terrace .....	3-23
3.3.140	Gallery.....	3-24

---

### 3.3.010 Purpose

This Division sets forth the standards for each private frontage within the Mission Boulevard Corridor Code Area. Private frontages are the components of a building that provide an important transition and interface between the public realm (street and sidewalk) and the private realm (yard or building). These standards supplement the standards for each zone in which the frontage types are allowed and are intended to ensure development that establishes the character and scale of Mission Boulevard and the adjacent walkable neighborhoods.

---

### 3.3.020 Applicability

The standards in this Division apply to all proposed development and renovations along front and street side facades within the Mission Boulevard Corridor Code Area, and must be considered in combination with the standards for the applicable zone and in the rest of this Article.

### 3.3.030 Overview

Table A (Frontage Types Overview) provides a list of the allowed frontage types by zone. The names of the frontage types indicate their particular configuration or function and are not intended to limit uses within the associated building. For example, a porch may be used by non-residential uses such as a restaurant or office as allowed by the zone.

FRONTAGE TYPE	SECTION	ZONES		
Front Yard	3.3.050	MB-CN	MB-NN	MB-CC
Porch: Projecting	3.3.060	MB-CN	MB-NN	MB-CC
Porch: Engaged	3.3.070	MB-CN	MB-NN	MB-CC
Stoop	3.3.080	MB-CN	MB-NN	MB-CC
Forecourt	3.3.090	MB-CN	MB-NN	MB-CC
Dooryard	3.3.100	MB-CN	MB-NN	MB-CC
Maker Shopfront	3.3.110	MB-CN	MB-NN	MB-CC
Shopfront	3.3.120	MB-CN	MB-NN	MB-CC
Terrace	3.3.130	MB-CN	MB-NN	MB-CC
Gallery	3.3.140	MB-CN	MB-NN	MB-CC

Key      Z=Zone      **Z** Allowed      **Z** Not Allowed

### 3.3.040 General to Private Frontages

- Each building must have at least one frontage type for each street frontage.
- Each building may have multiple frontage types in compliance with the allowed types in the zone.
- Frontage types not listed in the applicable zone standards are not allowed in that zone.

**3.3.050 Front Yard**

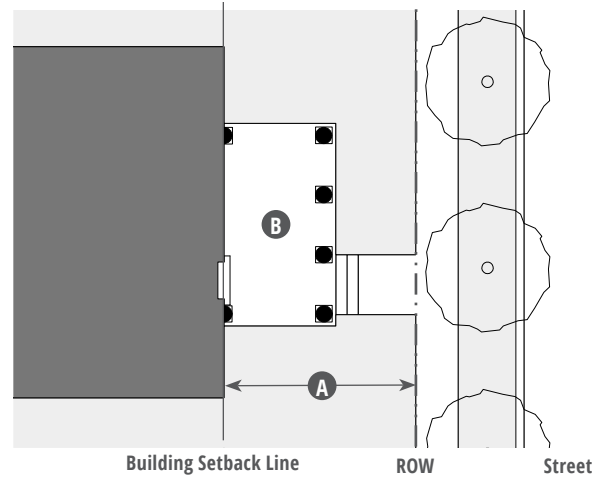
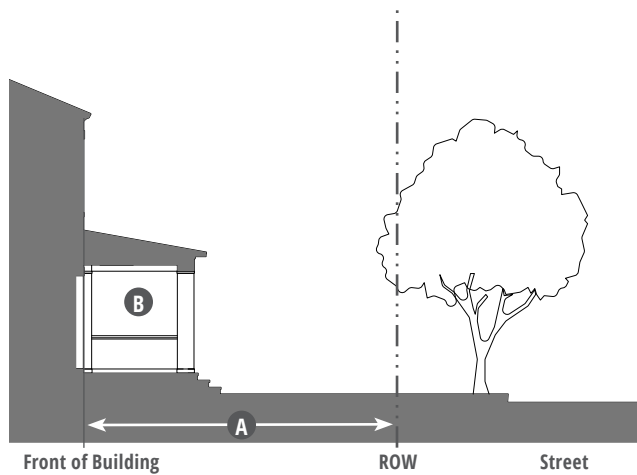

**Key**

---- ROW / Lot Line      ——— Building Setback Line

**A. Description**

The main facade of the building has a planted setback from the frontage line providing a buffer from the street. The yard may be fenced or unfenced to be visually continuous with adjacent yards, supporting a landscape that generates an open and green streetscape.

MB-CN

MB-NN

MB-CC

**B. Size/Dimensions**

Depth must comply with Subsection E (Building Placement) of the Zone standards. A

**C. Miscellaneous**

Fences are allowed between front yards or between the sidewalk and front yard.

Front Yard Frontage may be combined with Porch (see Sections 3.3.060 and 3.3.070) or Stoop (see Section 3.3.080). The Front Yard frontage type standards control in case of conflict. B



Front yard with landscaping



Small Front Yard with landscaping to help accent and define the space.

General Note: Photos on this page are illustrative, not regulatory.

**3.3.060 Porch: Projecting**

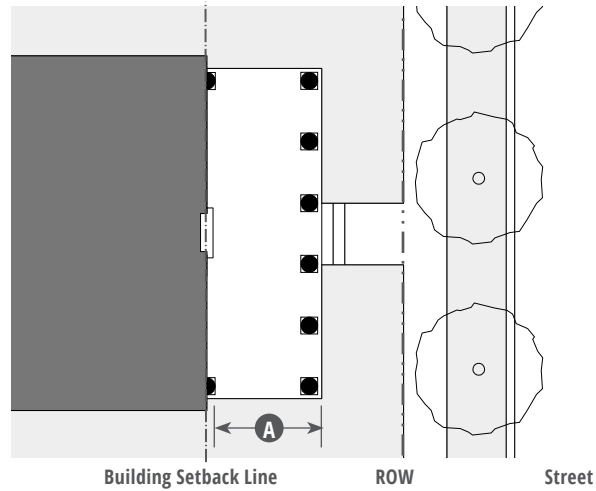
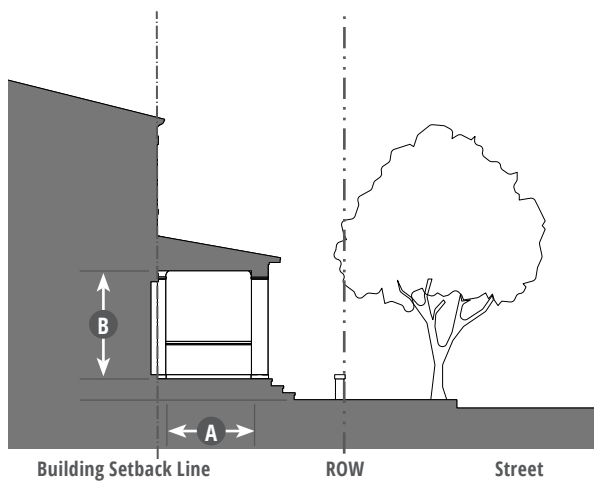

**Key**

---- ROW / Lot Line      - - - - Building Setback Line

**A. Description**

The main facade of the building is setback from the frontage line. The resulting front yard is typically small and can be defined by a fence or hedge to spatially maintain the edge of the street. The porch is open on three sides and all habitable space is located behind the building setback line.

MB-CN    MB-NN    MB-CC

**B. Size/Dimensions**

Depth, Clear	8' min.	<b>A</b>
Height, Clear	8' min.	<b>B</b>

**C. Miscellaneous**

Projecting porches must be open on three sides and have a roof.

A porch can encroach into the required setback.



*A projecting porch for a house form commercial use. .*



*A projecting porch on the front facade that creates a nice seating space.*

*General Note: Photos on this page are illustrative, not regulatory.*

**3.3.070 Porch: Engaged**

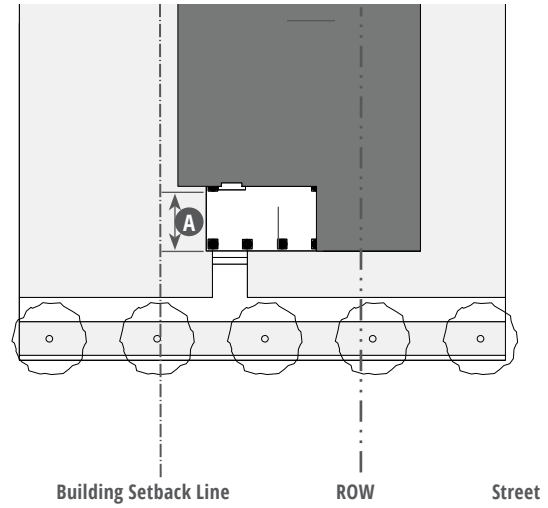
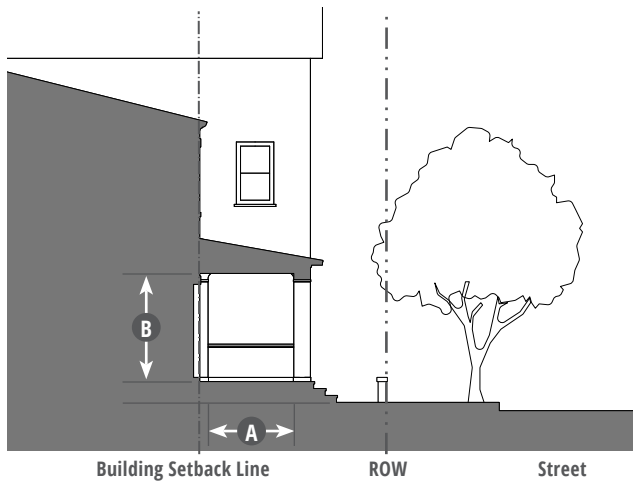

**Key**

---- ROW / Lot Line      - - - - Building Setback Line

**A. Description**

The main facade of the building is setback from the frontage line. The resulting yard is typically small and can be defined by a fence or hedge to spatially maintain the edge of the street. The porch has two adjacent sides that are engaged to the building while the other two sides are open.

**MB-CN**   **MB-NN**   **MB-CC**

**B. Size/Dimensions**

Depth, Clear	8' min.	<b>A</b>
Height, Clear	8' min.	<b>B</b>

**C. Miscellaneous**

Engaged porches must be open on two sides and have a roof.

A porch can encroach into the required setback.



*Engaged porch to second floor.*

*General Note: Photos on this page are illustrative, not regulatory.*

### 3.3.080 Stoop

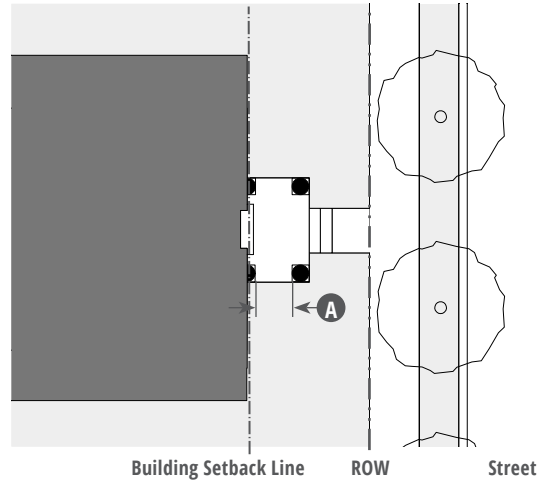
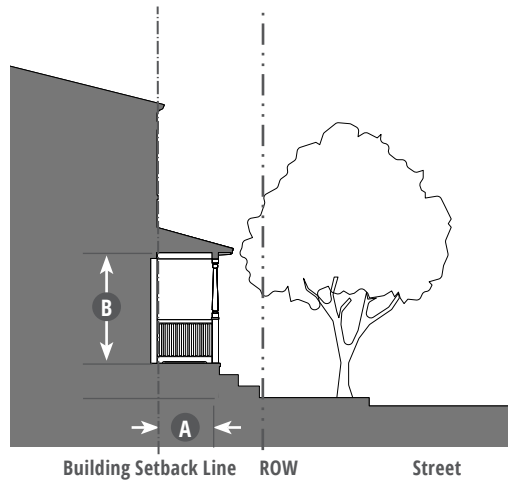

**Key**

----- ROW / Lot Line      - - - - - Building Setback Line

**A. Description**

The main facade of the building is near the frontage line and the stoop engages the first floor with the sidewalk. The stoop is elevated above the sidewalk to provide privacy along the sidewalk-facing rooms. Stairs or ramps from the stoop may lead directly to the sidewalk or may be side-accessed. The stoop is appropriate for residential ground floor uses.

MB-CN    MB-NN    MB-CC

**B. Size/Dimensions**

Depth, Clear	5' min.	<b>A</b>
Height, Clear	8' min.	<b>B</b>

**C. Miscellaneous**

Stairs may be perpendicular or parallel to the building facade.

Entry doors are covered or recessed to provide shelter from the elements.

All entry doors must face the street.



*Stoops define the entries to this Rowhouse building while elevating the ground floor from the street level.*



*Stoop with paired entries to dwelling portion of Live/Work units.*

*General Note: Photos on this page are illustrative, not regulatory.*



**3.3.090 Forecourt**

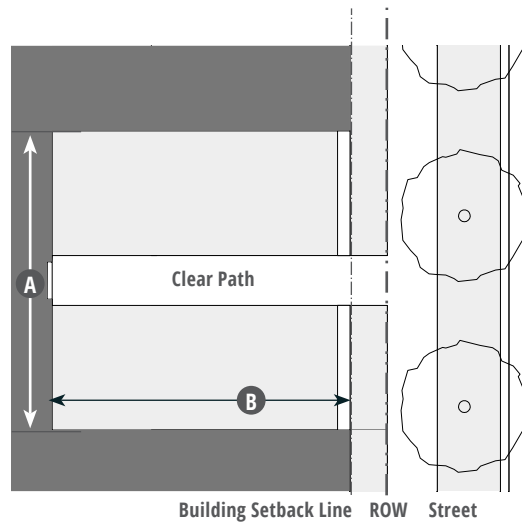
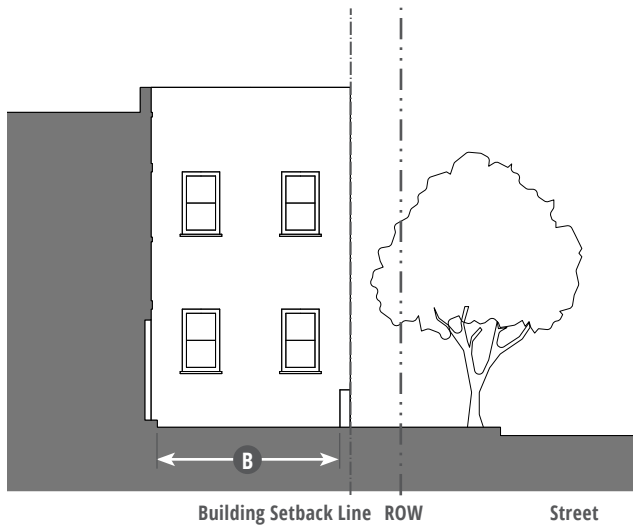

**Key**

---- ROW / Lot Line      - - - - Building Setback Line

**A. Description**

The main facade of the building is at or near the frontage line and a small portion of the building is set back, creating a small court and extending the public realm into the lot. The space may be used as an entry court or shared garden space for apartment buildings, or as an additional shopping or restaurant seating area within retail and service areas.

MB-CN    MB-NN    MB-CC

**B. Size/Dimensions**

Width, Clear	12' min.	<b>A</b>
Depth, Clear	12' min.	<b>B</b>

**C. Miscellaneous**

This type may be allocated in conjunction with other Frontage types

Forecourt may be utilized to group entries at a common elevation.



*Forecourt visually extends the public realm into this retail and office lot.*



*Forecourt provides unique entries to dwellings and breaks down the overall massing of the buildings shaping the space.*

*General Note: Photos on this page are illustrative, not regulatory.*

### 3.3.100 Dooryard

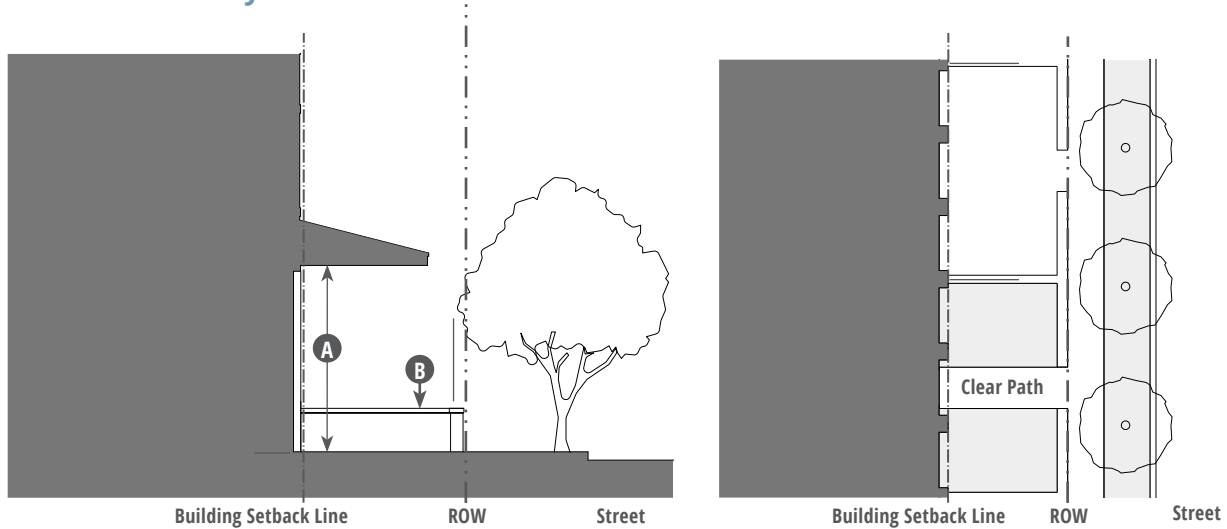

**Key**

----- ROW / Lot Line      - - - - - Building Setback Line

**A. Description**

The main facade of the building is set back a small distance and the frontage line is defined by a low wall or hedge, creating a small dooryard. The dooryard may not provide public circulation along a ROW. The dooryard may be raised, sunken, or at grade and may be used for ground-floor residential or non-residential uses.

MB-CN    MB-NN    MB-CC

**B. Size/Dimensions**

Height, Clear	8' min.	<b>A</b>
Height of Dooryard Fence/Wall	36" max.	<b>B</b>

**C. Miscellaneous**

Each Dooryard must provide access to only one ground floor entry.



*Small dooryards include low fences to provide a visual transition from the public sidewalk.*



*A series of small dooryards with small outdoor gardens along the front of each ground floor unit.*

*General Note: Photos on this page are illustrative, not regulatory.*

### 3.3.110 Maker Shopfront

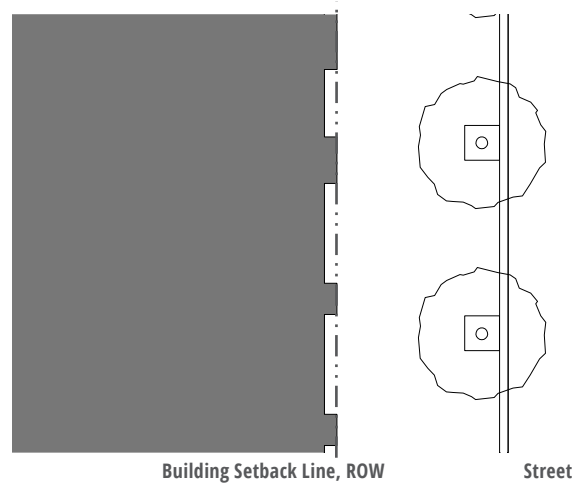
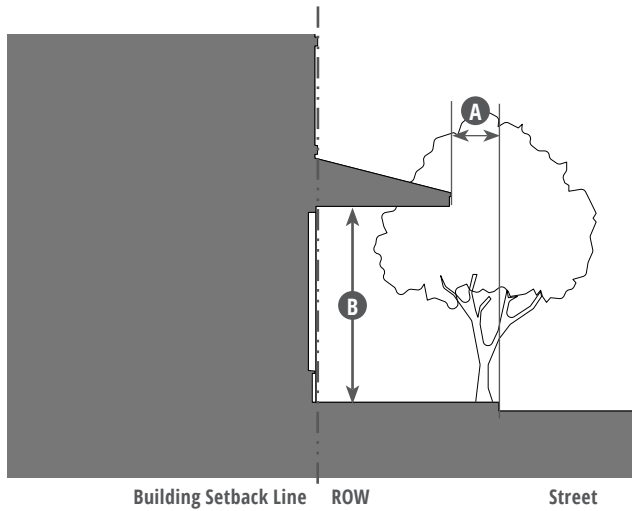

**Key**

---- ROW / Lot Line      - - - - Building Setback Line

**A. Description**

The main facade of the building is at or near the frontage line with an at-grade or elevated entrance from the sidewalk. The type is intended for industrial artisan businesses to show their activity to people passing by on the sidewalk as well as for retail sales of products made on-site. The type includes a decorative roll-down or sliding door, may include glazing and an awning that overlaps the sidewalk and may be used in conjunction with other frontage types allowed in the zone.

MB-CN    MB-NN    MB-CC

**B. Size/Dimensions**

Depth of Recessed Entries      5' max.

**C. Awning**

Setback from Curb      2' min.      **A**

Height, Clear      8' min.      **B**

**D. Miscellaneous**

Doors may be recessed when main facade is at the building setback line.



*Maker Shopfront with double doors for each entry.*

*General Note: Photos on this page are illustrative, not regulatory.*

### 3.3.120 Shopfront

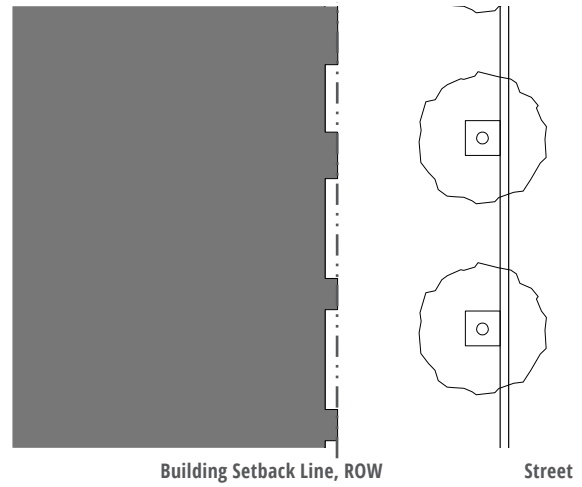
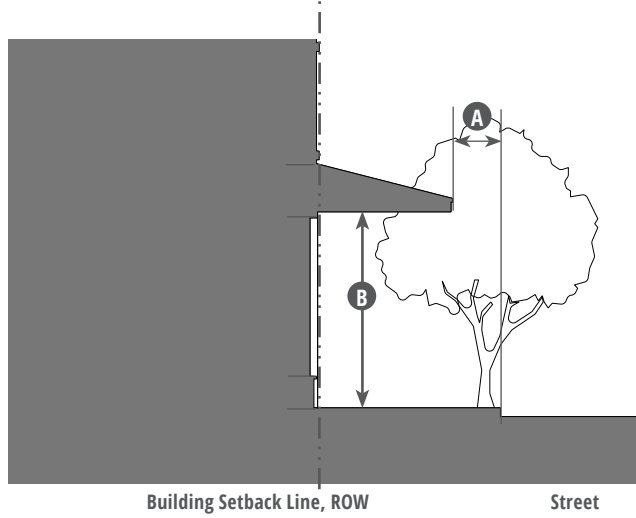

**Key**

--- ROW / Lot Line      - - - - Building Setback Line

#### A. Description

The main facade of the building is at or near the frontage line with at-grade entrance along the sidewalk. This type is intended for retail use, has substantial glazing between the shopfront base and the ground floor ceiling, and may include an awning that overlaps the sidewalk. This type may be used in conjunction with other frontage types allowed in the zone.

MB-CN    MB-NN    MB-CC

#### B. Size/Dimensions

Ground Floor Transparency	70% min.
Shopfront Base	2' max.

#### C. Awning

Setback from Curb	2' min.	<b>A</b>
Height, Clear	8' min.	<b>B</b>

#### D. Miscellaneous

Residential windows are not allowed on the ground floor.

Doors may be recessed when main facade is at the building setback line.



Shopfront frontage along ground floor of multi-story buildings.



Shopfront with recessed entry and simple large windows.

General Note: Photos on this page are illustrative, not regulatory.

**3.3.130 Terrace**

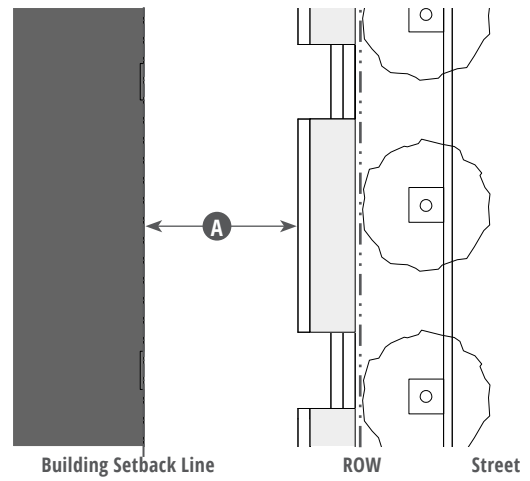
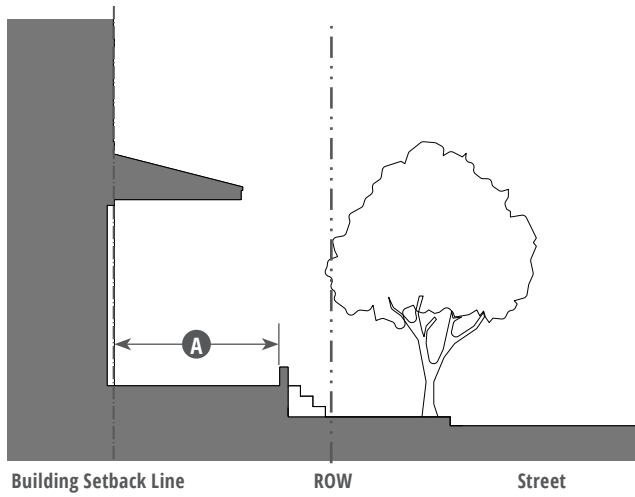

**Key**

---- ROW / Lot Line      - - - - Building Setback Line

**A. Description**

The main facade is set back from the frontage line with an elevated terrace providing public circulation along the facade. This type can be used to provide at-grade access while accommodating a grade change or buffer residential use from public sidewalk. Frequent steps up to the terrace are necessary to avoid blank sections of walls and to maximize access. This type may also be used in historic industrial areas to mimic historic loading docks.

MB-CN    MB-NN    MB-CC

**B. Size/Dimensions**

Depth of Terrace                      8' min.                      **A**

**C. Miscellaneous**

Low walls used as seating are allowed.

Where the zone requires the ground floor to be flush with the sidewalk, the terrace is considered to be the sidewalk.

Terrace may be utilized to group entries at a common elevation.



*Terrace accommodates a change in grade with low walls for seating while keeping visual connection with sidewalk.*

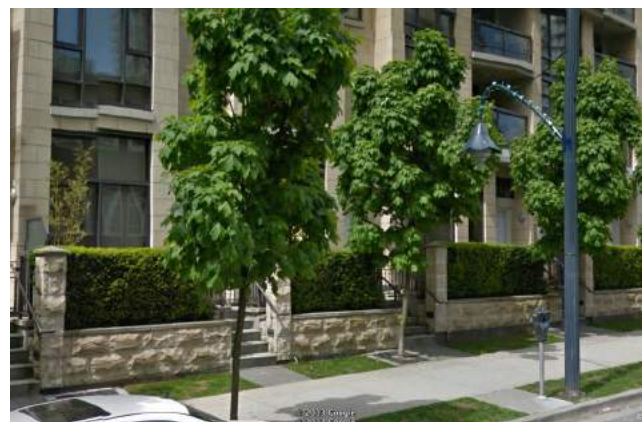

*One terrace spans across several ground floor townhouses with individual entries separated by landscaping.*

*General Note: Photos on this page are illustrative, not regulatory.*

**3.3.140 Gallery**

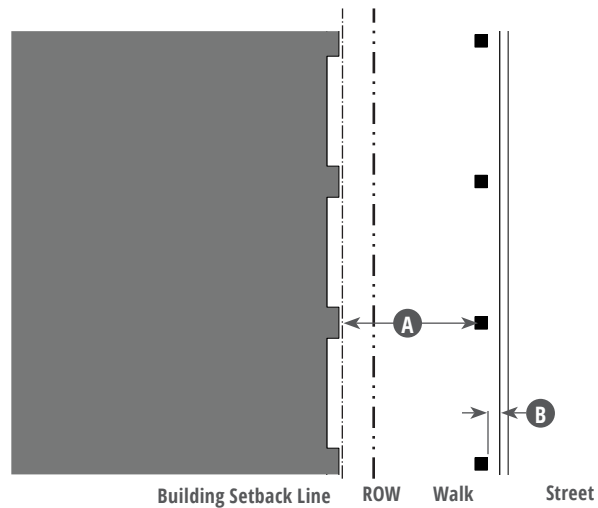
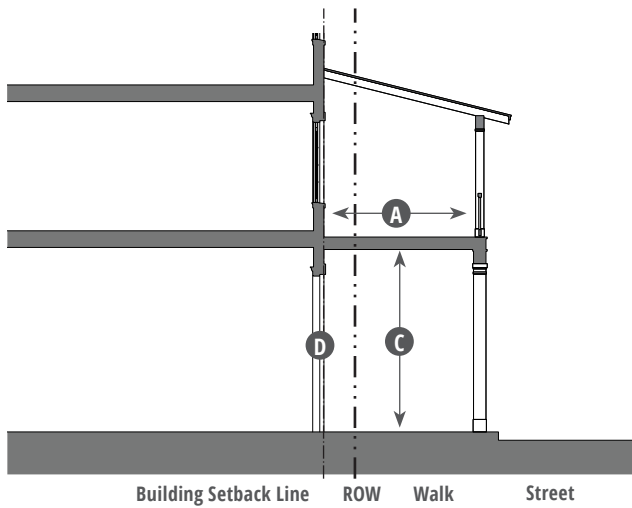

**Key**

---- ROW / Lot Line      - - - - Building Setback Line

**A. Description**

The main facade of the building is at or near the frontage line with a cantilevered shed or colonnade that may overlap the sidewalk. The gallery may support habitable space on the upper story. This type is intended for buildings with ground-floor commercial or retail uses and may be one or two stories. If the gallery overlaps the right-of-way, an easement is required. Alternatively the lot line may be aligned with the edge of the gallery and curb.

- MB-CN
- MB-NN
- MB-CC

**B. Size/Dimensions**

Depth, Clear	10' min.	A
Setback from Curb	2' min.	B
Height, Clear	10' min.	C

**C. Miscellaneous**

- Galleries must also follow the regulations for the [Shopfront Frontage Type](#) (See Section 3.3.110). D
- Galleries must have a consistent depth.
- Galleries must project over the sidewalk.



*One-story gallery.*



*A two-story gallery fronting a plaza.*

*General Note: Photos on this page are illustrative, not regulatory.*

## Division 3.4 Specific to Civic Spaces

---

### Sections

3.4.010	Purpose.....	3-25
3.4.020	Applicability.....	3-25
3.4.030	Overview.....	3-26
3.4.040	General to All Civic Spaces.....	3-26
3.4.050	Greenway.....	3-28
3.4.060	Green.....	3-29
3.4.070	Square.....	3-30
3.4.080	Pocket Plaza.....	3-31
3.4.090	Playground.....	3-32

---

### 3.4.010 Purpose

This Division sets forth the standards to provide a diverse palette of parks and other publicly accessible civic spaces that are publicly or privately owned throughout the Mission Boulevard Corridor. These standards supplement the standards for each zone in which the civic spaces are allowed and are intended to complement development and reinforce the character and scale of Mission Boulevard and the adjacent walkable neighborhoods. Civic space is a public benefit intended for use by the general community, and is distinct from private or common usable open space typically required as part of a residential project.

---

### 3.4.020 Applicability

This Division applies to any project where civic space is required, including Section 3.6.030(E), and is not exclusive to the MB-CS Zone.

### 3.4.030 Overview

- A. [Table A \(Civic Space Type Overview\)](#) provides an overview of the allowed civic space types in the Mission Boulevard Corridor Zones.
- B. The civic spaces specified in [Table A \(Civic Space Type Overview\)](#) are allowed as follows:
  1. **Allowed by Review.** Allowed if in compliance with the standards of this Division and if approved as part of Site Plan Review, Conditional Use Permit, Major Site Plan Review, or with an Administrative Use Permit.
  2. **Not Allowed.** Civic Space Types not allowed in the zone.

Table 3.4.030.A Civic Space Type Overview					
CIVIC SPACE TYPE	SECTION	ZONES			
Greenway	3.4.050	MB-CN	MB-NN	MB-CC	MB-CS
Green	3.4.060	MB-CN	MB-UN	MB-CC	MB-CS
Square	3.4.070	MB-CN	MB-NN	MB-CC	MB-CS
Pocket Plaza	3.4.080	MB-CN	MB-NN	MB-CC	MB-CS
Playground	3.4.090	MB-CN	MB-NN	MB-CC	MB-CS

Key      Z=Zone      **Z** Allowed by Review       Not Allowed

### 3.4.040 General to All Civic Spaces

- A. **Minimum Dimensions.** Minimum dimension of 25 feet by 25 feet
- B. **Building Frontage.** Buildings on lots adjacent to or across a thoroughfare from a civic space must be oriented to have the building facade face the civic space.
- C. **Public Access.** Public access and visibility from a public street and from on-site areas normally frequented by nearby uses, must be maintained.
- D. **Accessory Structure Standards.** Accessory structures within civic spaces, including, but not limited to, restrooms, open-air pavilions, gazebos, picnic shelters, and outdoor theaters, are subject to the standards of the applicable zone in [Division 2.2 \(Mission Boulevard Corridor Zones\)](#).



- E. **General Characteristics.** The placement of objects within the civic space.
1. **Natural.** Civic spaces with natural character must be designed in a natural manner with no formal arrangement of elements.
  2. **Formal.** Civic spaces with a formal character must be designed in a more rigid layout that follows geometric forms and has trees and other elements arranged in formal patterns.
  3. **Informal.** Civic spaces with an informal character must be designed to have a mix of formal and natural characteristics.
- F. **Design Criteria.** An area used for civic space must comply with the following:
1. Unless the land includes sensitive natural resources, a civic space area must be readily accessible and usable.
  2. The area may be developed using any practical combination of high quality plant and hardscape materials such as bricks, stone, concrete, permeable paving, or tile.
  3. The surface of the civic space must be suitable for outdoor activities, such as a lawn or paving for designated activities
  4. Locate seating areas and plazas should be located in areas with good solar exposure and wind protection.
  5. Civic space shall include benches or other seating. Amenities shall be included that enhance the comfort, aesthetics, or usability of the space, including but not limited to trees and other landscaping, shade structures, drinking fountains, water features, public art, trash receptacles, information kiosks, or performance areas.

**3.4.050 Greenway**

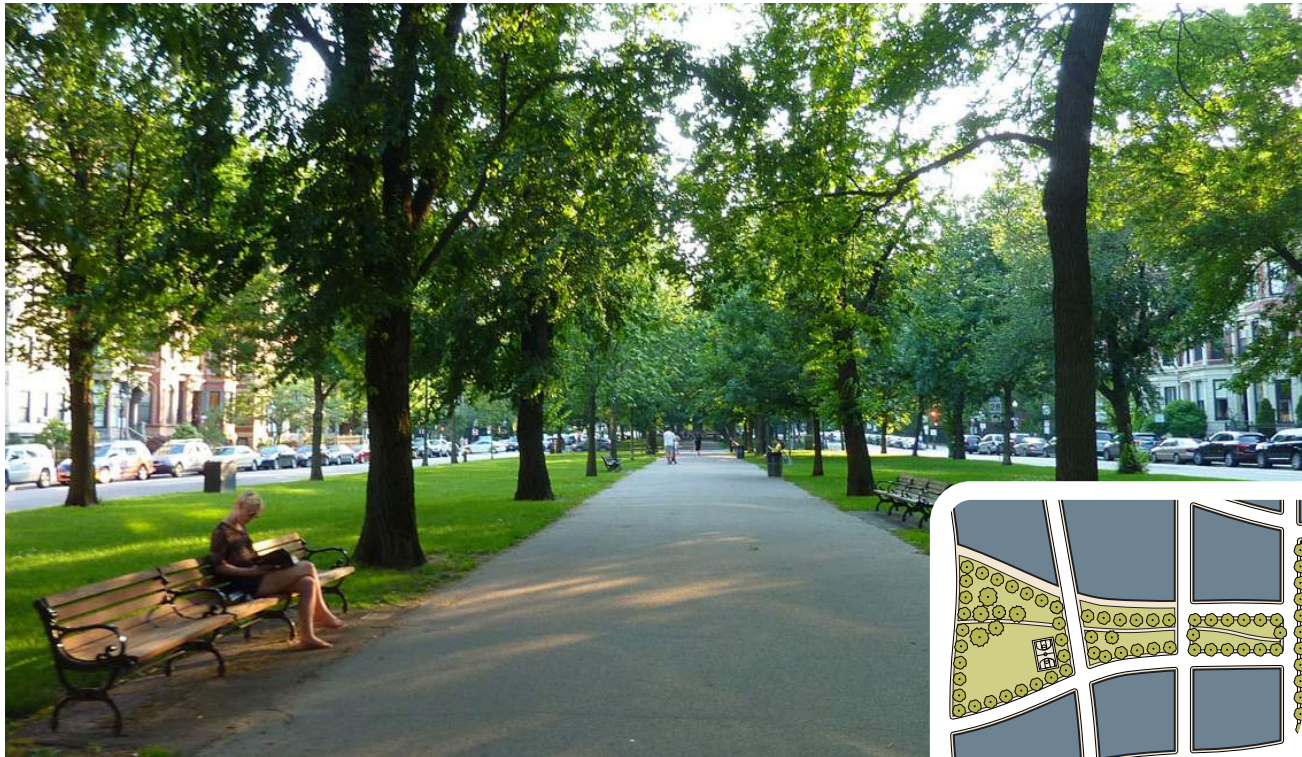

General Note: Images on this page are illustrative, not regulatory.

- MB-CN
- MB-NN
- MB-CC
- MB-CS

Key Z=Zone  Allowed by Review  Not Allowed

**A. Description**

Linear space for community gathering and strolling for nearby residents and employees, defined by tree-lined streets forming a one-way couplet on its flanks and by the fronting buildings across the street. Greenways can serve an important role as a green connector between destinations. Appropriate elements include community facility < 5,000 gsf., fountains, and benches.

**B. General Character**

Formal or informal

Hardscape or natural path

Spatially defined by tree-lined streets and adjacent buildings

**C. Size and Location**

Must front at least one street

**D. Typical Uses**

Passive recreation                      Walking/Running

Formal or informal seating

3.4.060 Green



- MB-CN
- MB-NN
- MB-CC
- MB-CS

Key Z=Zone  Allowed by Review  Not Allowed

**A. Description**

Open space available for unstructured and limited amounts of structured recreation. Appropriate elements include community facility < 5,000 gsf., fountains, and benches.

**B. General Character**

Informal or formal

Primarily planted areas with paths to and between recreation areas

Spatially defined by landscaping, tree-lined streets, and adjacent buildings

**C. Size and Location**

1/2 acre, min.

**D. Typical Uses**

Unstructured passive and active recreation

Civic uses

Temporary commercial uses

General Note: Images on this page are illustrative, not regulatory.

**3.4.070 Square**



General Note: Images on this page are illustrative, not regulatory.

- MB-CN
- MB-NN
- MB-CC
- MB-CS

Key Z=Zone  Allowed by Review  Not Allowed

**A. Description**

Neighborhood focal point available for civic purposes, commercial activity, and passive uses. Appropriate elements include kiosk, pergola, community facility < 5,000 gsf., fountains, and benches.

**B. General Character**

Formal  
 Combination of hardscape and planted areas in formal patterns

Spatially defined by tree-lined streets and adjacent buildings

Walkways and plantings at all edges, shaded seating areas

**C. Size and Location**

1/2 acre min., 5 acre max.

**D. Typical Uses**

Unstructured or structured recreation

Commercial and civic uses

Casual seating and/or outdoor dining

3.4.080 Pocket Plaza



- MB-CN
- MB-NN
- MB-CC
- MB-CS

Key Z=Zone  Allowed by Review  Not Allowed

**A. Description**

Small-scale, open space available for civic purposes and commercial activity, intended as spaces for seating or dining into which commercial and neighborhood activity may spill. Pocket plazas can also be used to create a formal space in front of a prominent building entrance. Appropriate elements include community facility < 1,000 gsf., fountains, and benches.

**B. General Character**

- Formal

---

- Primarily hardscape with landscape accents

---

- Spatially defined by building facades

---

- Trees and shrubs optional

**C. Size and Location**

5,000 sf min., 1/2 acre max.

**D. Typical Uses**

- Civic activity

---

- Commercial in support of civic activity

---

- Casual seating and/or outdoor dining

General Note: Images on this page are illustrative, not regulatory.

**3.4.090 Playground**



General Note: Images on this page are illustrative, not regulatory.

- MB-CN
- MB-NN
- MB-CC
- MB-CS

Key Z=Zone  Allowed by Review  Not Allowed

**A. Description**

Small-scale, open space designed and equipped for the recreation of children. These spaces serve as quiet, safe places protected from the street and typically in locations where children do not have to cross any major streets. An open shelter, play structures or interactive art and fountains may be included with landscaping between. Playgrounds may be included within all other civic space types.

**B. General Character**

- Focused toward children
- Play structure, interactive art, and/or fountains
- Shade and seating provided
- Protected from traffic; fenced with minimal exits
- Spatially defined by decorative fencing and trees

**C. Size and Location**

No min. or max.

**D. Typical Uses**

- Active and passive recreation
- Casual seating

## Division 3.5 Specific to Uses

---

### Sections

3.5.010	Telecommunication Facilities .....	3-33
3.5.020	Temporary Uses .....	3-34

---

### 3.5.010 Telecommunication Facilities

A. **Class 1 Telecommunication Facilities.** The following Telecommunication Facilities are classified as Class 1 facilities within the Code area:

1. Any Telecommunication Facility directly affixed to a building or structure, provided that all components of the facility are designed in a manner to be architecturally consistent with the building or structure. Examples include, without limitation, Telecommunications Facilities concealed within existing structures such as attics, cupolas, steeples, stanchions, bell towers, or similar structures, mounted to the penthouse of a building to appear as part of the architecture.
2. A ground-mounted or building-mounted receive-only radio or television satellite dish antenna which exceeds 36 inches in diameter but is not larger than 8 feet in diameter, provided the height of said dish does not exceed the height of the roof ridge line of a structure on which it is to be installed or is screened from view from the public right-of-way.
3. Any freestanding Telecommunications Facility designed to blend into the surrounding natural or man-made environment in order to minimize the overall visual impact. Examples include, without limitation, flag, telephone or light poles, palm trees, windmills, or rock formations and other similar items.
4. Any Telecommunications Facility proposed to co-locate on another freestanding existing Telecommunications Facility.
5. Government-owned and government-operated antenna(s).

The descriptions of Class 1 Telecommunication Facilities found in [Hayward Zoning Code Subection 10-13.070.a\(1\) through \(8\)](#) are inapplicable to the Code area.

B. **Allowed Facilities.**

1. Class 1 Telecommunication Facilities may be located in any zone within the Code area subject to Telecommunication Site Review approved by the Planning Director in accordance with [Municipal Code Chapter 10, Article 13 \(Antenna and Telecommunications Facilities Ordinance\)](#).
2. Class 2 and Class 3 Telecommunication Facilities are prohibited in the Code area.

- C. **Required Findings.** In addition to the findings required by [Hayward Zoning Code Section 10-13.070](#) and in order to approve a Telecommunications Site Review application, the Planning Director must find the proposed Telecommunication Facility is:
1. Sited and designed so as to be architecturally integrated such that it is virtually invisible to the naked eye from public streets and Civic spaces;
  2. The design, finish, colors and texture are non-reflective and blend with the surrounding natural and/or man-made environment; and
  3. If freestanding or pole-mounted, the height is the minimum necessary without compromising reasonable reception or transmission.
- D. **Other Requirements.** All other requirements of [Hayward Zoning Code Article 13 \(Antenna and Telecommunications Facilities Ordinance\)](#), apply.

---

### 3.5.020 Temporary Uses

- A. **Purpose.** The purpose of this Section is to establish standards for short term activities that would be compatible with adjacent and surrounding uses when conducted in compliance with this Section.
- B. **Applicability.** A Temporary Use allows short term activities that might not meet the normal development or use of standards of the applicable zone, but may otherwise be acceptable because of their temporary nature, when reviewed and appropriately conditioned in compliance with this Section and [Division 4.4 \(Temporary Use Permit\)](#).
- C. **Exempt Temporary Uses.** The following minor or limited duration temporary uses are exempt from the requirement for a Temporary Use Permit in [Division 4.4 \(Temporary Use Permit\)](#). Uses that do not fall within the categories defined below must comply with [Subsection E](#).
1. **Contractors' Construction Yards On-site.**
    - a. On-site contractors' construction/storage yard(s), in conjunction with an approved construction project on the same parcel, including, but not limited to, storage or cargo containers.
    - b. The construction yard must be removed immediately upon completion of the construction project, or the expiration of the companion Building Permit, authorizing the construction project, whichever first occurs.
  2. **Emergency Facilities.** Emergency public health and safety needs/land use activities, as determined by the Planning Director.
  3. **Fundraising Events.**
    - a. Fundraising events (e.g., bake sales, yard sales, car washes, etc.) are limited to a maximum of two days per month for each sponsoring organization.
    - b. Sponsorship is limited to educational, fraternal, religious, or service organizations directly engaged in civic or charitable efforts, or to tax exempt organizations in compliance with 501(c) of the Federal Revenue and Taxation Code.
  4. **Garage and Yard Sales.** Garage and yard sales (e.g., personal property sales) are allowed as Temporary Uses when conducted within a MB-CN or MB-NN zoned



property and are subject to the standards in [Subsection 10-1.2735.e \(Garage Sales\) of the Hayward Zoning Code](#).

5. **Sidewalk Dining.** Sidewalk dining, in compliance with [Section 3-5.13 of the Municipal Code](#).
- D. **Allowed Temporary Uses.** The following temporary uses and events require a Temporary Use Permit in compliance with [Division 4.4 \(Temporary Use Permits\)](#), and must comply with the following standards:
1. **Events.** In addition to the following standards, temporary events must comply with [Subsection 10-1.2735.h \(Outdoor Gatherings\) of the Hayward Zoning Code](#). If there is a conflict between this Section and the Municipal Code, this Section controls.
    - a. Circuses, carnivals, and similar transient amusement enterprises in a MB-CC Zone subject to no more than 30 days of site occupation and operation in any calendar year.
    - b. Music festivals, movie nights, outdoor art and craft shows and exhibits, and similar outdoor entertainment activities subject to a limitation on the number of days of operation as determined by the Planning Director.
  2. **Seasonal Sale Events.** Seasonal sale events (e.g., Halloween, Thanksgiving, Christmas, etc.) must comply with [Subsection 10-1.2735.c \(Christmas Tree and Pumpkin Patch Lot Regulations\) of the Hayward Zoning Code](#). Accessory uses, including temporary residence/security trailers, are only allowed on non-residential properties. Businesses holding valid a Business Permit, in compliance with [Chapter 8-1 \(Business Licenses\) of the Municipal Code](#) must not exceed 45 days for pumpkin and tree sales. Seasonal sales events may not occur more than four times per calendar year with a maximum of five days for each event.
  3. **Storage Containers.** Storage containers, including cargo containers or semitrailers, used for storage purposes.
    - a. No storage container may exceed a storage period of 15 days in any calendar year, except Subsection, below.
    - b. A storage container located on an active construction site may be retained longer than 15 days, but must be removed immediately following the issuance of a certificate of conformance or final inspection.
    - c. Storage containers are not allowed within the public ROW and must be placed to prevent public health or safety issues.
  4. **Tract Homes or Lot Sales Offices.**
  5. **Mobile Homes.** A mobile home to be utilized as a temporary dwelling in a residential zone while a single-family dwelling is under construction and subject to the following provisions:
    - a. The mobile home may only be located on the same parcel under construction and occupied while actual construction activities are taking place upon the parcel. The period of placement and use may not exceed 12 months.
    - b. The mobile home may only be occupied by the property owner, the builder designated on the Building Permit, and the owner's/ builder's family.
    - c. The timely removal and compliance with all conditions of approval may be required.

- d. The minimum setbacks for the zone must be maintained.
  - e. Additional conditions necessary and appropriate to ensure compatibility with surrounding development, existing and contemplated, may be imposed on the approved permit.
6. **Temporary Vegetable and Fruit Stands.** A temporary vegetable and/or fruit stand is allowed in compliance with the following standards:
- a. Vegetable and fruit stands must be operated by the producer;
  - b. The stand may not operate more than 90 days a year;
  - c. The producer shall obtain written consent from the land owner to operate a temporary vegetable and/or fruit stand on the property;
  - d. More than one stand per lot is prohibited;
  - e. Stands may encroach into required setbacks, but may not encroach into the public right-of-way.
- E. **General Requirements for All Temporary Uses.** The Review Authority (See [Division 4.4 \(Temporary Use Permit\)](#)) may impose requirements for any of the following conditions:
- 1. Compliance with all applicable Federal, State, or County, and local regulations and ordinances;
  - 2. Compliance with any other permit requirements (i.e., Building and/or Electric);
  - 3. Applicant availability during temporary use activity;
  - 4. Agreement that the temporary use will cease on the date printed on the permit, and all related equipment, supplies, product and personnel must be removed from the site; or
  - 5. Any other condition which will ensure the operation of the proposed temporary use or event in an orderly and efficient manner and in full compliance with the purpose of this Chapter, including those related to the following:
    - a. Cumulative time limits;
    - b. Parking;
    - c. Operating hours;
    - d. Screening;
    - e. Storm water;
    - f. Waste collection and disposal;
    - g. Pedestrian and vehicular access/circulation; and
    - h. Signs, in compliance with [Section 10-7.600 \(Temporary Sign Regulations\) of the Hayward Zoning Code](#).
- F. **Temporary Structures.** Temporary structures are allowed on vacant lots for a period not to exceed six months, provided the area is left unchanged and in its original condition after the removal of the temporary structure.
- G. **Temporary Use of Existing Structures.** Temporary, short-term, use of an existing structure is allowed in all zones, provided:

1. The short-term use, if a permanent use, would otherwise be a permitted use in the zone;
  2. The short-term tenant has signed a lease with the property owner for a time period of no more than six months.
- H. **Similar Temporary Uses.** Similar temporary uses, which are compatible with the zone and surrounding land uses, may require a Temporary Use Permit in compliance with [Division 4.4 \(Temporary Use Permit\)](#) and be subject to the standards in this Section, as determined by the Planning Director.
- I. **Condition of the Site Following Temporary Use.** Each site occupied by a temporary use must be cleaned of debris, litter, or any other evidence of the temporary use upon completion or removal of the use.

*This page intentionally left blank*

## Division 3.6: Standards for Large Sites

Sections

3.6.010	Purpose and Applicability .....	3-39
3.6.020	Major Site Plan Required .....	3-39
3.6.030	Development Requirements .....	3-40

### 3.6.010 Purpose and Applicability

- A. The intent of this Division is to:
  1. Create and reinforce compact and walkable urban environments with a mix of uses;
  2. Promote development patterns that support effective and convenient multi-modal transportation options, including pedestrian, bicycle, and public transit; and
  3. Provide opportunities for auto-oriented suburban contexts to transform into walkable urban development.
- B. The standards of this Division apply to new development or subdivision on sites that are two acres or larger in size or with more than 600 feet of cumulative front and side street frontage.



**A** Site with area greater than 2 acres    **B** Site with more than 600 feet of street frontage

### 3.6.020 Major Site Plan Required

Sites subject to this Division must obtain Major Site Plan Review in compliance with [Section 10-1.3000 \(Site Plan Review\) of the Hayward Zoning Code](#) and the requirements of this Division.

### 3.6.030 Development Requirements

#### A. Block Size

1. The total block perimeter must comply with the standards established in [Table A \(Block Size\)](#).
2. If a block or site contains multiple zones, smallest applicable block perimeter applies.

Zone	New Block Perimeter
MB-CN, MB-CS	2,400 ft. max.
MB-NN	2,800 ft. max.
MB-CC	2,000 ft. max.

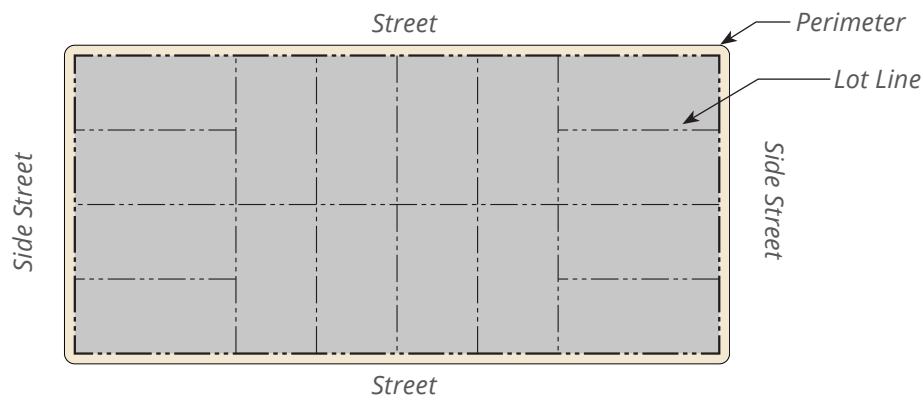

- B. **Thoroughfares.** Thoroughfares, public or private, define the streets, pedestrian paths, and bicycle routes that refine large sites into walkable urban environments that may also provide multiple routes for vehicular circulation.

#### 1. General to All.

- a. Thoroughfares are intended to provide multi-modal access to lots and civic spaces.
- b. Thoroughfares shall consist of vehicular lanes (including parking and bicycle lanes) and public frontages (including sidewalks and amenities) consistent with City complete streets principles and City plans for improvements.
- c. Pedestrian comfort shall be a primary consideration of the thoroughfare.
- d. Where presented, design conflicts between vehicular and pedestrian movement generally shall be decided in favor of the pedestrian.

#### 2. Design.

- a. Thoroughfares must comply with Department of Public Works and Utilities standards.
- b. The thoroughfare network must indicate the layout on streets, pedestrian paths, and bicycle facilities (as appropriate), and the block network in compliance with standards in this Subsection and [Subsection A](#).
- c. Thoroughfares shall accommodate sidewalks, Bicycle Lanes, Bicycle Routes and Bicycle Trails (if applicable) consistent with the City of Hayward Bicycle and Pedestrian Master Plan and any other plans for network improvements.

- d. Thoroughfares that pass through multiple zones must transition to align with the character of the zone. For example, while a thoroughfare within a Mission Boulevard- Corridor Center (MB-CC) Zone with retail shops may have wide sidewalks with trees in tree grates, it may transition to a narrower sidewalk with a planting strip within a less urban zone with lower intensity residential uses (e.g., Mission Boulevard-Corridor Neighborhood (MB-CN) Zone).

### 3. External Connectivity.

- a. Thoroughfares must be arranged to connect to existing or proposed thoroughfares into adjoining lands whether the adjoining lands are undeveloped and intended for future development, or if the adjoining lands are developed and include opportunities for such connections.
- b. Thoroughfare rights-of-way must be extended to or along adjoining property boundaries to provide a roadway connection or thoroughfare stub for development in compliance with the standards in [Subsection A \(Block Size\)](#).
- c. The site plan must identify all stubs for thoroughfares and include a notation that all stubs must connect with future thoroughfares on adjoining undeveloped property.
- d. Dead-end streets and cul-de-sacs are not allowed. This does not apply to public or private driveways leading to parking facilities, including garages, parking lots, or parking structures.

### 4. Specific to Bicycle and Pedestrian Connections.

The site circulation system must include a system of bicycle and/or pedestrian paths that, at minimum, include the following:

- a. Internal Connections. A system of pedestrian walkways shall connect all buildings on a site to each other, to on-site automobile and bicycle parking areas, and to any on-site common open space areas, civic spaces, or pedestrian amenities. Walkways must be physically separated from drive aisles, except when crossing a drive aisle.
- b. External Connections.
  - (1) Regular connections between on-site walkways and the public sidewalk shall be provided. An on-site walkway shall connect the primary building entry or entries to a public sidewalk on each street frontage.
- c. Direct and convenient access shall be provided from commercial and mixed-use projects to adjoining residential and commercial areas to the maximum extent feasible while still providing for safety and security.
- d. Safe and convenient pedestrian connections shall be provided from transit stops to building entrances.
- e. Pedestrian access must consist of an accessible, easily discernible, well-lit, and ADA compliant walkway a minimum of 5 feet in width.

- C. **Land Use.** The site shall provide a mix of land uses consistent with the uses allowed in [Division 2.3 \(Use Table\)](#), including a variety of entertainment, recreational, retail, residential, and supporting uses to create an active, mixed-use environment.
- D. **Civic Space.** Minimum of 10 percent of the net project area must be designed as civic space in compliance with [Division 3.4 \(Civic Space\)](#). Net project area is the area after subtracting streets right-of-way from the project area.

*This page intentionally left blank*



# Article 4: Permits and Procedures

<b>Division 4.1 Purpose</b>		<b>4-3</b>
4.1.010	Purpose .....	4-3
4.1.020	Applicability.....	4-3
<b>Division 4.2 Site Plan Review</b>		<b>4-5</b>
4.2.010	Site Plan Review .....	4-5
4.2.020	Major Site Plan Review .....	4-5
<b>Division 4.3 Minor Modifications</b>		<b>4-7</b>
4.3.010	Modification .....	4-7
4.3.010	Purpose and Applicability.....	4-7
4.3.020	Review Procedures.....	4-7
4.3.030	Modification Allowed.....	4-8
4.3.040	Findings for a Decision on a Minor Modification .....	4-9
4.3.050	Review and Decision .....	4-9
<b>Division 4.4 Temporary Use Permit</b>		<b>4-11</b>
4.4.010	Purpose and Applicability.....	4-11
4.4.020	Review Procedures.....	4-11
4.4.030	Findings .....	4-12
4.4.040	Lapse of Approval.....	4-12
4.4.050	Time Limits .....	4-13
4.4.060	Appeals.....	4-13

*This page intentionally left blank*

## Division 4.1 Purpose

---

Sections

4.1.010	Purpose.....	4-3
4.1.020	Applicability.....	4-3

---

### 4.1.010 Purpose

This Article establishes the review procedures for the administration of the Mission Boulevard Corridor Code and to ensure that each new or expanded use or structure complies with the applicable requirements of this Code and the Hayward Municipal Code.

---

### 4.1.020 Applicability

This Article applies to the use and development of property within the Mission Boulevard Corridor Code Area and shall be considered in addition to the applicable permit and review procedure requirements in any other section of this Code or the Hayward Municipal Code.

*This page intentionally left blank*

## Division 4.2 Site Plan Review

---

### Sections

4.2.010	Site Plan Review. . . . .	4-5
4.2.020	Major Site Plan Review . . . . .	4-5

---

### 4.2.010 Site Plan Review

Site Plan Review, pursuant to [Section 10-1.3000 of the Hayward Zoning Code](#), is required for all development projects and uses. If the project also requires Planning Commission approval, the project shall be processed and reviewed concurrently by the Planning Commission.

---

### 4.2.020 Major Site Plan Review

On sites of two or more acres or with more than 600 feet of street frontage, Major Site Plan Review, pursuant to [Section 10-1.3075 of the Hayward Zoning Code](#), shall be obtained prior to any subdivision or other approval for new development.

*This page intentionally left blank*

## Division 4.3 Minor Modifications

---

### Sections

4.3.010	Modification . . . . .	4-7
4.3.010	Purpose and Applicability . . . . .	4-7
4.3.020	Review Procedures . . . . .	4-7
4.3.030	Modification Allowed . . . . .	4-8
4.3.040	Findings for a Decision on a Minor Modification . . . . .	4-9
4.3.050	Review and Decision . . . . .	4-9

---

### 4.3.010 Modification

Modifications to the dimensional requirements of property development standards may be granted pursuant to [Section 10-1.2830, Conformance-Administrative Modification, of the Hayward Zoning Code](#) and as specifically identified in any section of this Code.

---

### 4.3.010 Purpose and Applicability

- A. The purpose of a Minor Modification is to streamline and expedite the permitting process by authorizing the Planning Director to allow minor deviations from certain code standards when such requests constitute a reasonable use of the property but are not otherwise permissible under a strict application of this Chapter.
- B. The provisions of this Division are intended to ensure that development of property within Mission Boulevard Corridor Zones:
  1. Makes a positive contribution to existing development on neighboring properties;
  2. Ensures that new or altered structures are compatible and harmonious with the design and use of existing structures on neighboring properties;
  3. Respects the existing views, privacy, and access to light and safety of neighboring properties; and
  4. Does not adversely affect neighboring properties, with “adversely affect” to mean to impact in a substantial, negative manner the economic value, habitability, or enjoyability of these properties.

---

### 4.3.020 Review Procedures

- A. **Application Filing and Processing.** The application must be filed with the Planning Director and include the information and materials in the most current Department publication for applications together with the required fee as specified in [Section 10-1.2815 \(Application\) of the Hayward Zoning Code](#). It is the responsibility of the applicant to provide evidence in support of the findings required by [Section 4.3.040 \(Findings for a Decision on a Minor Modification\)](#).

- B. The Planning Director may approve a Minor Modification as specified in [Table 4.3.030.A \(Minor Modifications Allowed\)](#), only after first determining that the requested modification complies with the findings specified in [Section 4.3.040 \(Findings for a Decision on a Minor Modification\)](#).
- C. A request for a modification beyond modification allowed in [Section 4.3.030 \(Modification Allowed\)](#) may apply for a Variance in compliance with [Section 10-1.3300 \(Variance\) of the Municipal Code](#), as appropriate.

### 4.3.030 Modification Allowed

- A. **General Modification.** The Planning Director may approve a Minor Modification in any Mission Boulevard Corridor Zone for a modification of up to 20 percent of any measurable standard prescribed in this Code, only after first determining that the requested modification complies with the findings specified in [Section 4.3.040 \(Findings for a Decision on a Minor Modification\)](#).
- B. **Additional Modification.** In addition to the modification allowed under [Subsection A](#), the Planning Director may approve a modification as provided in [Table A \(Minor Modifications Allowed\)](#). If the modification in [Table A \(Minor Modifications Allowed\)](#) is less permissive than [Subsection A](#), [Table A](#) supersedes.

Type of Minor Modification Allowed	Maximum Modification
Reduced front or street-side setbacks, provided at least 25% of the lots on the block contain primary buildings, the subject lot is vacant, and there would be no conflict with the ultimate right-of-way	To the minimum front or street-side yard setback of any primary building along the same block face
Increase in maximum projection into setback for porches, balconies, and stairways	10%
Reduced side or rear setbacks for detached private garages and accessory structures, provided the garage or structure is does not exceed 10 feet in height within the required setback and does not create a condition causing water to drain onto an adjacent site	3 feet into the required side or rear setback
Reduced minimum parking setback, provided that parking is not located in front of the main building along the primary facade.	25% reduction of the minimum
Reduced side street frontage for multi-family projects on corner lots with primary street frontage	Waive minimum side street frontage requirement
Increase in maximum block perimeter	5%
Increase in maximum setback	10%
Minimum Open Space	10%



---

#### 4.3.040 Findings for a Decision on a Minor Modification

The Planning Director shall review and approve or disapprove an application for a Minor Modification, with or without conditions, only after the following findings are made:

- A. There are special circumstances applicable to the property (e.g., size, shape, topography, location, surroundings, etc.) that the strict application of the Code could deprive the property of privileges enjoyed by other property in the vicinity and under identical zoning classification;
- B. The special circumstances applicable to the property are not self-imposed by any person presently having and interest in the property;
- C. Granting the Minor Modification will not be materially detrimental to the public health, safety, or welfare and will not impair an adequate supply of light and air to adjacent property;
- D. The requested Minor Modification will not allow the establishment of a use that is not allowed in the zone;
- E. The requested Minor Modification will not allow an increase in height or density beyond which is allowed in the base zone; and
- F. The proposed project will comply with all applicable standards in this Code.

---

#### 4.3.050 Review and Decision

- A. Each Minor Modification application must be reviewed on an individual case-by-case basis.
- B. A request for modification that exceeds 10 percent of the required standard is subject to notice in compliance with [Section 10-1.2820 \(Notice\) of the Hayward Zoning Code](#).
- C. A decision on a Minor Modification may be appealed in compliance with [Section 10-1.2845 \(Appeal and Review Process\) of the Hayward Zoning Code](#).

*This page intentionally left blank*

## Division 4.4 Temporary Use Permit

---

### Sections

4.4.010	Purpose and Applicability .....	4-11
4.4.020	Review Procedures .....	4-11
4.4.030	Findings .....	4-12
4.4.040	Lapse of Approval .....	4-12
4.4.050	Time Limits .....	4-13
4.4.060	Appeals .....	4-13

---

### 4.4.010 Purpose and Applicability

- A. This Division establishes the procedures for the review of Temporary Use Permits required by this Code for temporary uses and/or activities that have a short duration, are compatible with adjacent and surrounding uses when conducted in compliance with this Code when reviewed and appropriately conditioned in compliance with this Division. Standards for specific temporary uses are identified in [Section 3.5.020 \(Temporary Uses\)](#).
- B. A Temporary Use Permit is required to allow the temporary uses and/or short-term activities specified in [Section 3.5.020 \(Temporary Uses\)](#), unless exempted by [Subsection 3.5.020.D \(Allowed Temporary Uses\)](#).

---

### 4.4.020 Review Procedures

- A. **Application Filing and Processing.** The application must be filed with the Planning Director and include the information and materials in the most current Department publication for applications together with the required fee as specified in [Section 10-1.2815 \(Application\) of the Hayward Zoning Code](#). It is the responsibility of the applicant to provide evidence in support of the findings required by [Section 4.4.030 \(Findings\)](#).
- B. **Administrative Options.** The Planning Director may approve, conditionally approve, or disapprove a Temporary Use Permit application. The Planning Director's decision must be based on the findings listed in [Section 4.4.030 \(Findings\)](#). For uses not listed in [Section 3.5.020 \(Temporary Uses\)](#), the Planning Director may determine if the use is allowed with a Temporary Use Permit or requires an Administrative Use Permit in compliance with [Section 10-1.2715 \(Certain Uses Permitted\) the Hayward Zoning Code](#).
- C. **Conditions of Approval.** In approving a Temporary Use Permit application, the Planning Director may impose conditions of approval that are considered reasonable and necessary to ensure that the permit would be in full compliance with the findings required by [Section 4.4.030 \(Findings\)](#). This may include conditions from other City departments (e.g., Public Works) that may have a direct effect on the operation of the temporary use. Conditions may address any pertinent factors affecting the operation of the temporary event or use to ensure the operation of the proposed event or use is temporary in nature.

---

#### 4.4.030 Findings

The Planning Director may approve a Temporary Use Permit subject to making all the following findings:

- A. The location, operation, and time period of the temporary use will not constitute a hazard to the public interest, health, safety, or general welfare.
- B. The operation of the temporary use will not be detrimental to adjoining properties through the creation of excessive dust, light, noise, odor, or other undesirable characteristics.
- C. The site on which the temporary use is proposed is adequate in size and shape to accommodate the temporary use without detriment to the enjoyment of other properties located adjacent to and near the subject property.

---

#### 4.4.040 Lapse of Approval

- A. A Temporary Use Permit becomes void if not used within six months following its effective date, or within a shorter time specifically prescribed as a condition of the Temporary Use Permit, or at the expiration of an associated development permit if that occurs at a later time. The Planning Director may extend the time for a maximum period of one additional six-month period only, if an application is filed before the expiration of the six month or shorter time period.
- B. Where the conditions of a Temporary Use Permit have not been or are not being complied with, the Planning Director shall give written notice to the permittee of intention to revoke or modify the Temporary Use Permit and shall set a date for a public hearing with the Planning Commission in compliance with [Section 10-1.2820 \(Notice\) of the Hayward Zoning Code](#) upon the proposed revocation or modification. The notice must be served on the owner of the subject property by mailing the notice to the owner at the address shown on the last equalized assessment roll at least 10 days before the date of the hearing, and specify the date, time, and place when and where it will be held. Following the hearing, and if the Planning Director finds that there is good cause the Temporary Use Permit may be modified or revoked.
- C. If a structure or use granted under a Temporary Use Permit is abandoned for a period of 30 days, the Temporary Use Permit expires.

---

**4.4.050 Time Limits**

- A. A Temporary Use Permit is valid for up to 180 days in any given calendar year, unless otherwise stipulated in [Section 3.5.020 \(Temporary Uses\)](#) or the Planning Director determines that another time limit is necessary to comply with the findings in [Section 4.4.030 \(Findings\)](#).
- B. The Planning Director may limit the number of Temporary Use Permits approved for each lot in a calendar year to avoid temporary uses becoming effectively permanent uses consistent with the intent of this Division.

---

**4.4.060 Appeals**

A decision for a Temporary Use Permit can be appealed in compliance with [Section 10-1.2845 \(Appeal and Review Process\)](#) of the [Hayward Zoning Code](#).

*This page intentionally left blank*

# Article 5: Definitions

---

<b>Division 5.1 General Terms and Definitions</b>	<b>5-3</b>
5.1.010 Purpose and Intent .....	5-3
5.1.020 Land Uses .....	5-3
5.1.030 General Terms.....	5-3

*This page intentionally left blank*



## Division 5.1 General Terms and Definitions

---

### Sections

5.1.010	Purpose and Intent . . . . .	5-3
5.1.020	Land Uses . . . . .	5-3
5.1.030	General Terms . . . . .	5-3

---

### 5.1.010 Purpose and Intent

This Article describes and classifies land uses and terms that apply to the Mission Boulevard Corridor Zones. This Article supplements, and supersedes, if in conflict with, the terms defined in [Section 10-1.3500 \(Definitions\)](#) in the Hayward Municipal Code. Where this Article is silent, the definitions of the Hayward Municipal Code apply.

---

### 5.1.020 Land Uses

Land uses are defined in [Article 1, Section 10-1.3500, Definitions, of the Hayward Municipal Code](#).

---

### 5.1.030 General Terms

**Block.** An area of land separated from other areas by adjacent streets, railroads, rights of-way, or public areas.

**Building Elevation.** The exterior wall of a building not adjacent to a public right-of-way, the front or side along a private street, or civic space.

**Building Façade.** The vertical surface of a building, generally placed facing a frontage line (“front facade”).

**Civic Space.** Land that is improved for civic gathering purposes.

**Commercial.** the term collectively defining workplace, Office, Retail Sales, and Lodging Functions.

**Density.** the number of dwelling units within a standard measure of land area.

**Dooryard.** A Frontage Type wherein the main facade of the building is set back a small distance and the frontage line is defined by a low wall or hedge, creating a small dooryard (see Section 3.3.100).

**Driveway.** A vehicular lane within a site or shared between two sites leading to a garage, or other approved parking or loading area.

**Encroachment.** Any architectural feature, structure or structural element, such as a gallery, fence, garden wall, porch, stoop, balcony, oriel window, bay window, terrace or deck, that breaks the plane of a vertical or horizontal regulatory limit extending into a setback, or beyond the zero lot line into the public frontage, or above a height limit.

**Enfront.** to place an element along a Frontage, as in “porches Enfront the street.”

**Facade Zone.** The area between the minimum and maximum setback lines along the front of a parcel and along the side street of a corner parcel.

**Forecourt.** A Frontage Type wherein the main facade of the building is at or near the frontage line and a small portion of the building is set back (see Section 3.3.090).

**Front Yard.** A Frontage Type wherein the main facade of the building has a planted setback from the frontage line (see Section 3.3050).

**Frontage.** A strip or extent of land abutting a thoroughfare, civic space, or other public right-of-way.

Private Frontage. The area between the building facade and the shared lot line between the public right-of-way and the lot.

Public Frontage. The area between the curb of the vehicular lanes and shared lot line between the public right-of-way and the lot.

Frontage Line. A lot line bordering a Public Frontage. Facades facing Frontage Lines define the public realm and are therefore more regulated than the Elevations facing other Lot Lines.

**Gallery.** A Frontage Type wherein the main facade of the building is at or near the frontage line and a cantilevered shed or colonnade overlaps the sidewalk in the right-of-way (see Section 3.3.140).

**Green.** A Civic Space Type wherein a natural preserve or open space is available for unstructured recreation (see Section 3.4.060).

**Greenway.** A Civic Space Type wherein linear space is available for community gathering and strolling for nearby residents and employees (see Section 3.4.050).

## Height

**Building Height.** The vertical distance at any point from the finished grade or existing grade, whichever is lower, to the highest point of the coping of a flat roof, to the top roof line of a mansard roof, or to the midpoint of the highest gable of a pitched or hip roof (see Section 10-1.3510 in the Hayward Municipal Code).

**Ground Floor, Finished Floor.** Height from finished grade to the top of the flooring material of the ground floor.

**Ground Floor, Ceiling.** Height from finished floor to finished ceiling of primary rooms on the floor(s) above the ground floor, not including secondary rooms such as bathrooms, closets, utility rooms, and storage spaces.

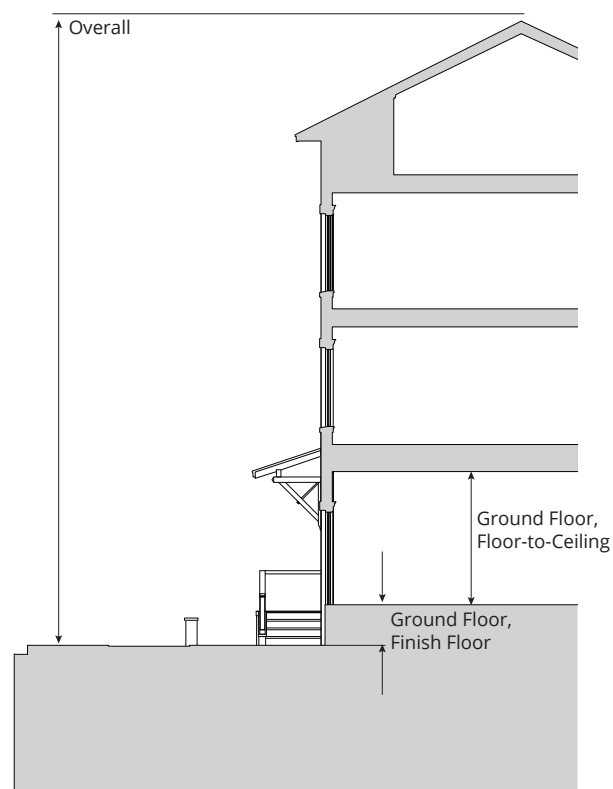

Figure 6.1.030.1 Height

**Lot Width, net.** The lot width excluding portions of the lot dedicated to driveways or access, including fire access.

**Maker Shopfront.** A Frontage Type wherein the main facade of the building is at or near the frontage line with an at-grade or elevated entrance from the sidewalk (see Section 3.3.110).

**Parking Structure.** Facilities for the temporary parking of motor vehicles within a privately or publicly owned off-street parking facility. This use includes commercial parking lots and garages.

**Playground.** A Civic Space Type wherein open space is designed and equipped for the recreation of children (see Section 3.4.090).

**Pocket Plaza.** A Civic Space Type wherein open space is available for civic purposes and commercial activities (see Section 3.4.080).

**Porch: Engaged.** A Frontage Type wherein the main facade of the building is setback from the frontage line with an attached porch that has two adjacent sides that are engaged to the building while the other two sides are open (see Section 3.3.070).

**Porch: Projecting.** A Frontage Type wherein the main facade of the building is setback from the frontage line with an attached porch that is open on three sides and all habitable space is located behind the building setback line (see Section 3.3.060).

**Primary Entrance.** The main point of access for pedestrians into a building.

**Regulating Plan.** A map for a development that identifies zones to be applied to replace the existing zones. Upon approval of the development, the regulating plan's content is incorporated into the Hayward Zoning Map.

**Residential.** Characterizing premises available for long-term human dwelling.

**Shopfront.** A Frontage Type wherein the main facade of the building is at or near the frontage line with at-grade entrance along the sidewalk (see Section 3.3.120).

**Sidewalk.** The paved section of the Public Frontage dedicated to pedestrian activity.

**Square.** A Civic Space Type wherein a neighborhood available for civic purposes, recreation, and passive uses (see Section 3.4.070).

**Stoop.** A Frontage Type wherein the main facade of the building is near the frontage line and the stoop engages the first floor with the sidewalk (see Section 3.3.080).

**Terrace.** A Frontage Type wherein the main facade is set back from the frontage line with an elevated terrace (see Section 3.3.130).