



22626 4th Street Residential Project

Draft Initial Study – Mitigated Negative Declaration

prepared by

City of Hayward

777 B Street, 3rd Floor

Hayward, California 94541

Contact: Jay Lee, Associate Planner, (510) 583-4207

prepared with the assistance of

Rincon Consultants, Inc.

449 15th Street, Suite 303

Oakland, California 94612

May 2018

22626 4th Street Residential Project

Draft Initial Study – Mitigated Negative Declaration

prepared by

City of Hayward

777 B Street, 3rd Floor

Hayward, California 94541

Contact: Jay Lee, Associate Planner, (510) 583-4207

prepared with the assistance of

Rincon Consultants, Inc.

449 15th Street, Suite 303

Oakland, California 94612

May 2018

This report prepared on 50% recycled paper with 50% post-consumer content.

Table of Contents

Initial Study	1
1. Project Title	1
2. Lead Agency Name and Address	1
3. Contact Person and Phone Number	1
4. Project Location	1
5. Project Sponsor’s Name and Address	1
6. General Plan Designation	1
7. Zoning	1
8. Description of Project	4
9. Surrounding Land Uses and Setting	9
10. Required Approvals	14
11. Other Public Agencies Whose Approval is Required	14
Environmental Factors Potentially Affected	15
Determination	15
Environmental Checklist	17
1 Aesthetics	17
2 Agriculture and Forestry Resources	19
3 Air Quality	21
4 Biological Resources	27
5 Cultural Resources	41
6 Geology and Soils	47
7 Greenhouse Gas Emissions	53
8 Hazards and Hazardous Materials	57
9 Hydrology and Water Quality	63
10 Land Use and Planning	73
11 Mineral Resources	75
12 Noise	77
13 Population and Housing	89
14 Public Services	91
15 Recreation	95
16 Transportation/Traffic	97
17 Tribal Cultural Resources	109
18 Utilities and Service Systems	112
19 Mandatory Findings of Significance	116
References	118
Bibliography	118
List of Preparers	122

Tables

Table 1	Project Summary.....	4
Table 2	Health Effects Associated with Non-Attainment Criteria Pollutants.....	22
Table 3	Air Quality Thresholds of Significance	23
Table 4	Plant Species Observed on the Project Site	32
Table 5	Location and Number of Trees to be Removed	37
Table 6	Approximate Fault Distances from the Project Site.....	48
Table 7	Noise Measurement Results	79
Table 8	Typical Noise Levels at Construction Sites	81
Table 9	Significance of Changes in Operational Roadway Noise Exposure.....	83
Table 10	Daily Trips on Area Roadways.....	84
Table 11	Vibration Levels for Construction Equipment at Noise-Sensitive Receptors.....	86
Table 12	Intersection Level of Service and Delay Thresholds	98
Table 13	Level of Service – Existing Conditions	99
Table 14	Intersection Traffic Warrants – Existing Conditions	99
Table 15	Queuing – Existing Conditions	99
Table 16	Proposed Project Trip Generation	100
Table 17	Existing plus Project Conditions Intersection Level of Service.....	101
Table 18	Intersection Traffic Warrants – Existing Plus Project Conditions	101
Table 19	Queuing – Existing Plus Project Conditions	102
Table 20	Westbound Queuing – 4th Street and B Street	104
Table 21	Existing Bicycle Counts.....	105

Figures

Figure 1	Regional Location.....	2
Figure 2	Project Site Location	3
Figure 3	Proposed Site Plan	5
Figure 4	Proposed Landscaping Plan – North Site	7
Figure 5	Proposed Landscaping Plan – South Site	8
Figure 6	Proposed Project Elevations – Plans 1, 2, and 3	10
Figure 7	Proposed Project Elevations – Plans 4 and 5	11
Figure 8	Site Photographs.....	12
Figure 9	Surrounding Area Photographs.....	13
Figure 10	Noise Measurement Locations	80

Appendices

Appendix A	Arborist Report
Appendix B	Preliminary Geotechnical Assessment
Appendix C	Noise Measurement Data
Appendix D	Transportation Assessment

This page intentionally left blank.

Initial Study

1. Project Title

22626 4th Street Residential Project

2. Lead Agency Name and Address

City of Hayward – Development Services Department
Planning Division
777 B Street, 3rd Floor
Hayward, California 94541

3. Contact Person and Phone Number

Jay Lee, AICP, Associate Planner, (510) 583-4207

4. Project Location

The project site encompasses approximately 5.1 acres and consists of five assessor's parcels on either side of B Street just west of its intersection with 4th Street in the City of Hayward (APN#s 427-0036-033-05, 427-0036-033-06, 427-0036-033-07, 427-0036-085-01, and 427-0036-055-019). Figure 1 shows the location of the project site in the regional context. Figure 2 shows an aerial view of the project site and immediate surroundings. Interstate 880 (I-880) and Interstate 580 (I-580) provide regional access to the project site.

5. Project Sponsor's Name and Address

Dutra Enterprises, Inc.
43360 Mission Boulevard, Suite 230
Fremont, California 94539

6. General Plan Designation

LDR (Low Density Residential) and MDR (Medium Density Residential)

7. Zoning

RS (Single Family Residential)

City of Hayward
22626 4th Street Residential Project

Figure 1 Regional Location

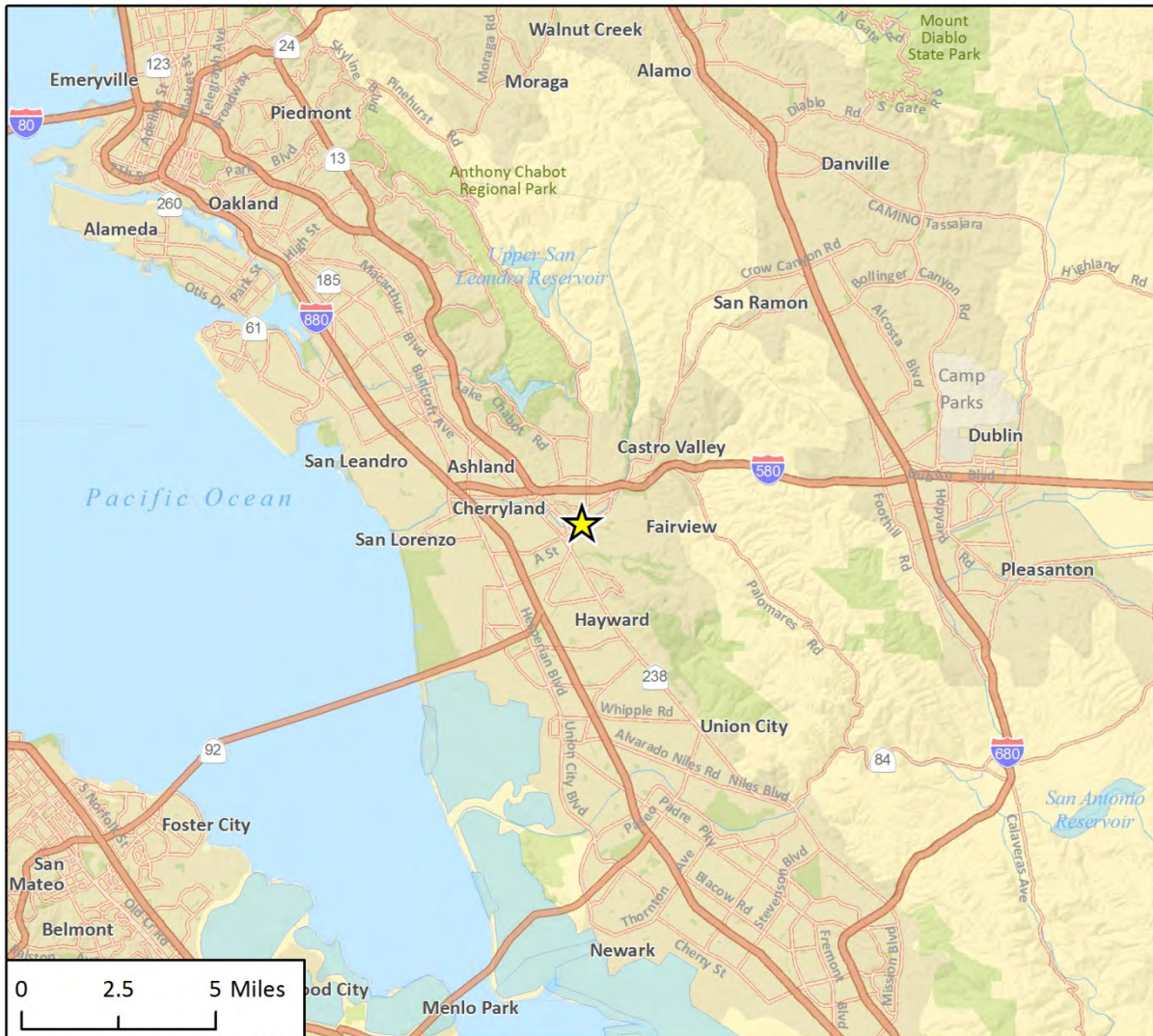

Imagery provided by Esri and its licensors © 2018.

★ Project Location

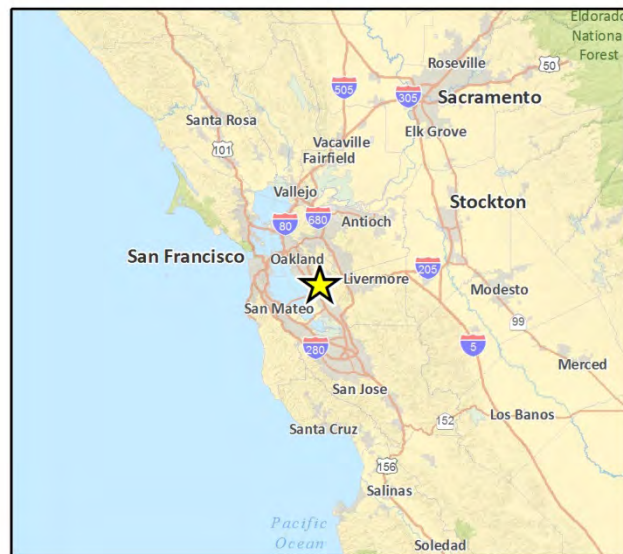

Fig 1. Regional Location

Figure 2 Project Site Location



Imagery provided by Google and its licensors © 2018.

Fig 2 Project Location

8. Description of Project

The proposed project requires a rezoning and subdivision of an approximately 5.1-acre site into 45 lots in order to develop 41 detached single-family residences, common open space, and private streets that would have vehicular access from two public streets: B Street and Chestnut Street. Approximately 0.67 acres of land along San Lorenzo Creek that is part of the project site would be kept as an open space area and maintained by the project Homeowners Association (HOA). The lot lines of the nearest proposed residences to the creek would be set back approximately 15 feet from the top of the creek bank.

Forty-one of the 45 lots would be developed with single-family residences. Residential lots would range in size from 2,012 to 5,020 square feet. Three lots totaling 46,126 square feet would provide common open space for the residents. One 1,703 square-foot lot would contain a stormwater bioretention area. Aside from the common open space areas, the project would include private open space for each residence. Twenty-five of the units would be located in the northern portion of the project site north of B Street and 16 units would be located in the southern portion of the project site south of B Street. Figure 3 shows the proposed site plan.

The project includes a request for a zone change from the existing RS (Single-Family Residential) District to a new PD (Planned Development) District to accommodate the project. Currently, the 5.1-acre site is undeveloped but previously was developed with five single-family residences that were demolished in 2017.

Table 1 summarizes the characteristics of the project.

Table 1 Project Summary

Project Size	
Acres	5.1 acres
Residential Units	
Three-bedroom	21 units
Four-bedroom	20 units
Total	41 units
Parking	
Garage	82 spaces
On-street	30 spaces
Open Space	
Private	29,558 sf
Shared	16,578 sf
Total	46,136 sf
Notes: sf = square feet	

Figure 3 Proposed Site Plan



Source: Ruggeri Jensen Azar 2018

Access and Parking

Vehicular access to the project site would be provided via three driveway entrances from B Street (one entrance to the area north of B Street and two entrances to the area south of B Street) and one driveway entrance from Chestnut Street to the internal private circulation network. Each single-family residence would be accessed via a driveway from the proposed new private streets and would include a garage sized to fit two vehicles. Thirty-four of the units would also have driveways that could accommodate a parked vehicle.

To facilitate pedestrian access, the project includes the installation and improvement of sidewalks along the project frontage, including filling in sidewalk gaps along 4th Street adjacent to the project. Pedestrian and bicycle access points to the project include the sidewalk-adjacent frontages as well as the project driveways.

Sidewalk improvements on 4th Street also involve development of vehicle parking spaces on 4th Street. Twelve street parking spaces would be developed on 4th Street (seven north of B Street and five south of B Street). Eighteen street parking spaces would be provided on the internal private circulation network.

Open Space and Landscaping

The landscaping plans for the project are shown on Figure 4 (north site) and Figure 5 (south site). The project includes private open space for each residential unit as well as shared common open space areas. The amount of private open space for each unit ranges between 100 and 2,168 square feet. Shared common open space in the form of a trail system would be located along the project's 4th Street frontage (9,513 square feet) and also within a 7,065-square-foot open space area near the northwestern corner of the project site. The trail system would integrate both planting and hardscaping materials and the main open space area on 4th Street would include exercise stations and bench seating. The approximately 29,204 square foot area along San Lorenzo Creek is proposed to be kept as open space and would be maintained by the HOA.

Currently, there are approximately 109 trees located on or near the project site, including five off-site trees with canopies that extend on the project site and nine street trees adjacent to the project site (HortScience, Inc. 2017). Approximately 84 of these trees would be removed, including trees native to California such as Incense cedar (*Calocedrus decurrens*), Coast live oak (*Quercus agrifolia*), Coast redwood (*Sequoia sempervirens*), California bay (*Umbellularia californica*) and Monterey pine (*Pinus radiata*). Of the 109 trees located on or near the project site, 25 trees are proposed to remain. The project includes the planting of 44 new trees throughout the project site and along the 4th and B Street frontages. According to the preliminary plant palette, planted trees would include Norway maple, red maple, honey locust, purple-leaf plum, and white crape myrtle trees. As shown on Figure 4 and Figure 5, the landscaping and irrigation systems would comply with the City's current Water-Efficient Landscape Ordinance and Bay-Friendly Water Efficient Landscape Ordinance, utilizing low-flow spray, bubbler, or drip irrigation methods.

To help reduce stormwater run-off, the project would incorporate silva cells¹ throughout the project site. Additionally, two stormwater bioretention areas are proposed in the northern portion of the site to capture and treat runoff.

¹ The Silva Cell is a modular building block that contains soil beneath paving. Silva cells support traffic loads and accommodate utilities while treating stormwater on-site.

Figure 4 Proposed Landscaping Plan – North Site

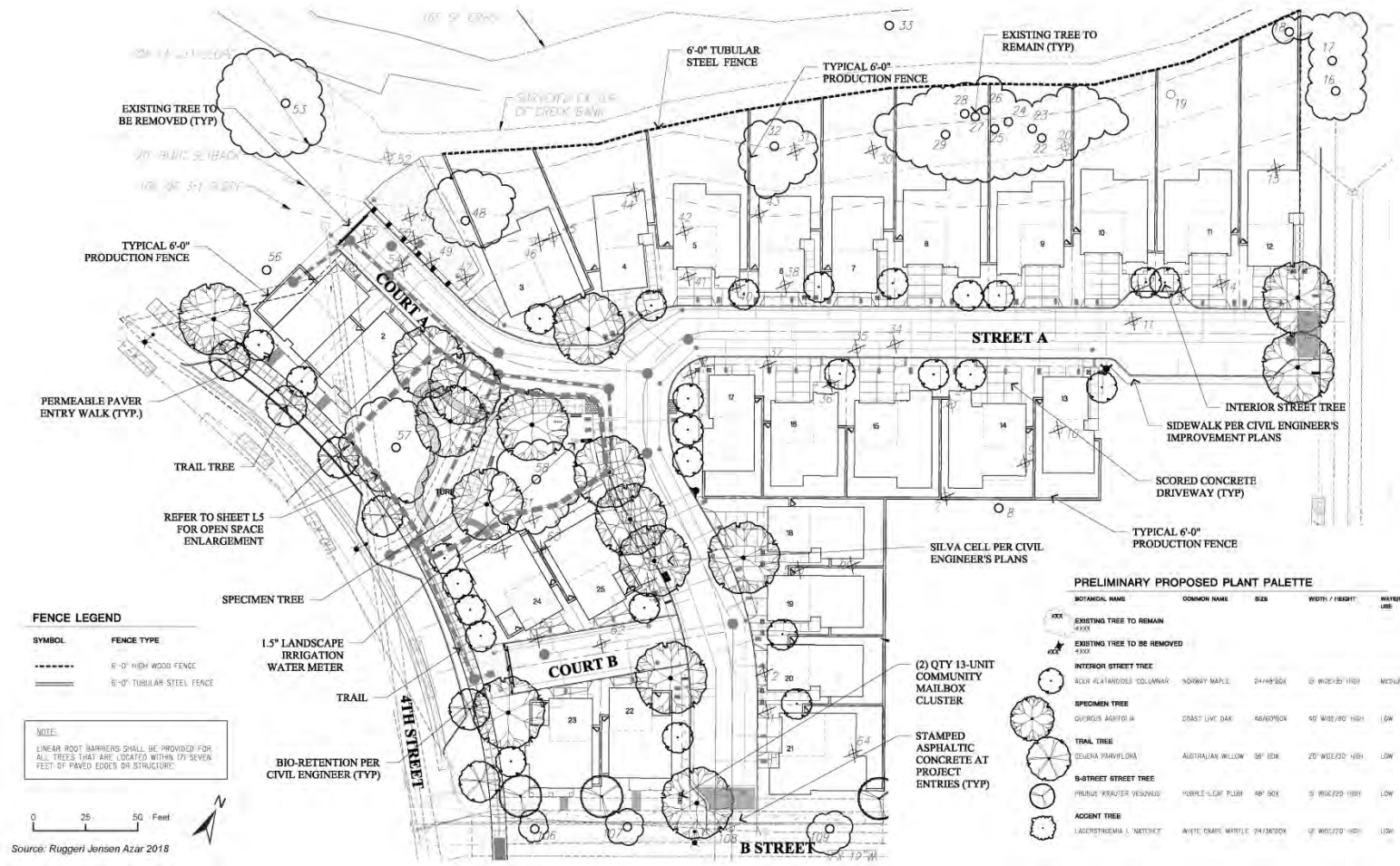

City of Hayward
22626 4th Street Residential Project

Figure 5 Proposed Landscaping Plan – South Site

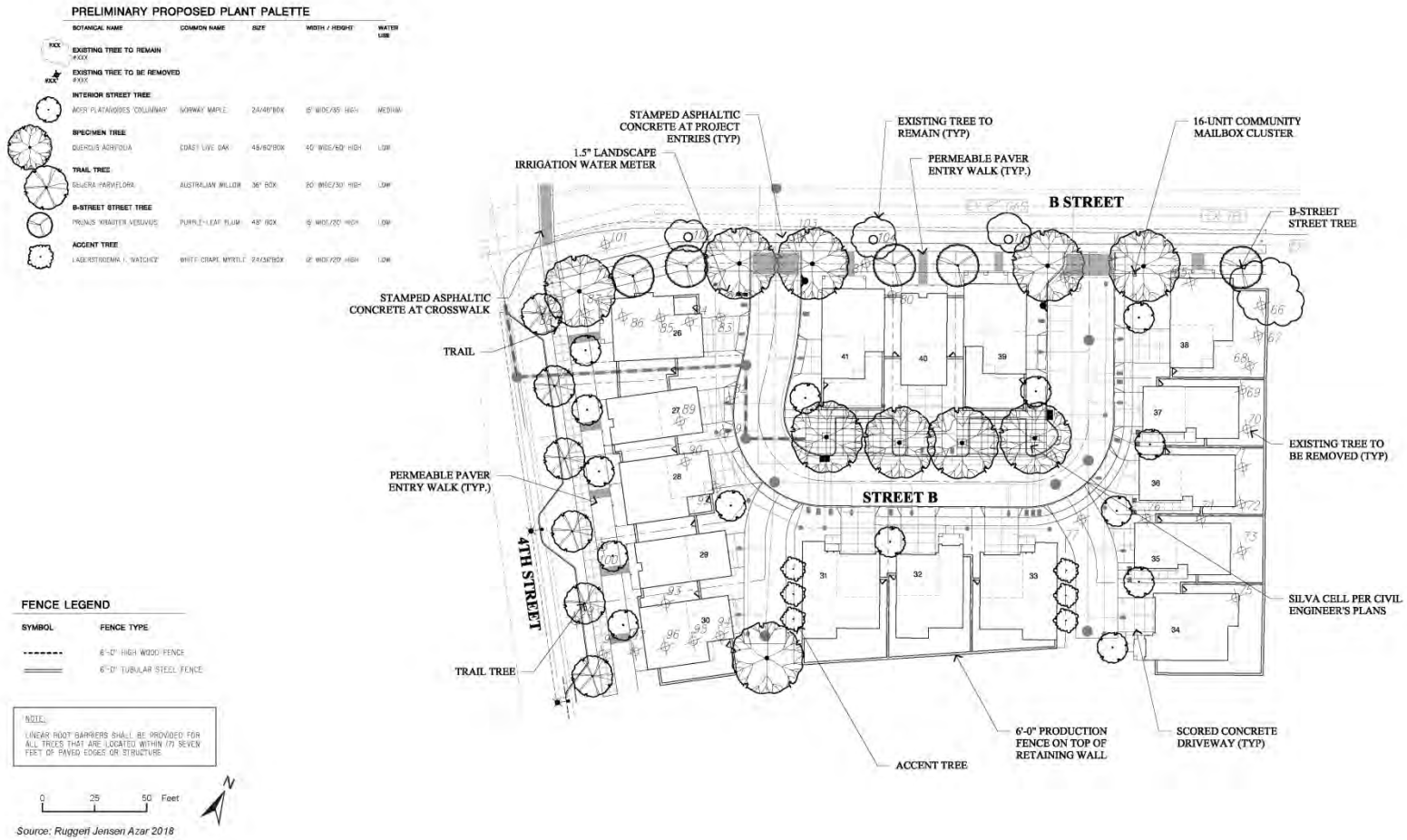

Building Architecture and Design

The proposed single-family, detached residential buildings would be similar to each other in height, scale, and mass. Each residence would be two stories in height and would range from 1,452 to 2,223 gross square feet in size (gross square feet measurement excludes garage area). Several architectural styles would be proposed depending on the building and floor plan and would include Victorian and Craftsman styles. Units would include typical Victorian and Craftsman style features such as full wrap siding and porches as appropriate to match the style. Architectural details would include stone veneers, detailed garage doors, front porches, tile roofing, stucco finishes, exterior shutters, and sill treatments. The proposed project would not include street lights, although each of the proposed residences would have external lighting to illuminate front yard areas and driveways. Architectural elevations are shown in Figure 6 (Plans 1, 2, and 3) and Figure 7 (Plans 4 and 5).

Each residence would include rooftop solar photovoltaic (PV) panels. In addition, all garages would be prewired to accommodate charging for electric vehicles.

Utilities

Utility services to the project site including water, sanitary sewer, storm drain, fire protection, and police protection are provided by the City of Hayward. Solid waste collection and recycling are provided by Waste Management of Alameda County. Pacific Gas and Electric (PG&E) provides both gas and electric service to the project site. Proposed on-site stormwater treatment facilities would be private and owned and maintained by the Home Owners Association (HOA).

9. Surrounding Land Uses and Setting

The project site is approximately five acres in size and is located in the northern portion of the City of Hayward in the East Bay region of the San Francisco Bay Area. The project site is located approximately four miles east of San Francisco Bay and approximately 0.5 mile west of the foothills of the southern coast range.

The project site is located in the Upper B Street neighborhood, which has been identified as a potential historic district and is characterized by single-family and multi-family residences and commercial buildings that are one to two stories in height. Architectural styles that represented neighborhood include Queen Ann cottages, Folk Victorian residences, Neoclassical rowhouses and cottages, modest workers cottages, one and two-story Craftsman style dwellings, and California bungalows (City of Hayward 2010).

Photos of the project site and surrounding area are shown in Figure 8 and Figure 9.

The project is bordered by San Lorenzo Creek and A Street to the north, 4th Street to the west, single-family residences to the south, and Chestnut street and single-family residences to the east. Across 4th Street to the west are one- and two-story commercial and office buildings. Across San Lorenzo Creek to the north is A Street and residential and office development. The area surrounding the project site includes residential, commercial, and industrial development and small areas of open space. B Street bisects the project site in a west-east direction.

The project site is currently undeveloped and generally level except for the creek banks and channel. Previously, the site was developed with single-family residences that were demolished in 2017.

City of Hayward
22626 4th Street Residential Project

Figure 6 Proposed Project Elevations – Plans 1, 2, and 3



ELEVATION '1B'



ELEVATION '1A'



Shown with Optional Glass at Garage Door

ELEVATION '2B'



Shown with Optional Glass at Garage Door

ELEVATION '2A'



Shown with Optional Glass at Garage Door

ELEVATION '3B'



Shown with Optional Glass at Garage Door

ELEVATION '3A'

Source: KTG 2018



Figure 7 Proposed Project Elevations – Plans 4 and 5



ELEVATION '4B'



ELEVATION '4A'



ELEVATION '5B'



ELEVATION '5A'

Source: KTG 2018



City of Hayward
22626 4th Street Residential Project

Figure 8 Site Photographs



Photo 1: View of project site north of B Street from Chestnut Street.



Photo 2: View of project site south of B Street from 4th Street.

Figure 9 Surrounding Area Photographs



Surrounding Area Photo 1: Residences along 4th Street adjacent to the project site south of B Street.



Surrounding Area Photo 2: Residences along B Street adjacent to the project site south of B Street.

City of Hayward
22626 4th Street Residential Project

10. Required Approvals

The following approvals and permits from the City of Hayward would be required for the project:

- Tentative Parcel Map
- Zone change from Single Family Residential (RS) to a new Planned Development (PD) District
- Grading Permit
- Building Permit

11. Other Public Agencies Whose Approval is Required

The City of Hayward is the lead agency with responsibility for approving the project. No other public agency's approval is required.

Environmental Factors Potentially Affected

This project would potentially affect the environmental factors checked below, involving at least one impact that is “Potentially Significant” or “Potentially Significant Unless Mitigation Incorporated” as indicated by the checklist on the following pages.

- | | | |
|--|---|---|
| <input type="checkbox"/> Aesthetics | <input type="checkbox"/> Agriculture and Forestry Resources | <input type="checkbox"/> Air Quality |
| <input checked="" type="checkbox"/> Biological Resources | <input checked="" type="checkbox"/> Cultural Resources | <input checked="" type="checkbox"/> Geology and Soils |
| <input type="checkbox"/> Greenhouse Gas Emissions | <input checked="" type="checkbox"/> Hazards and Hazardous Materials | <input checked="" type="checkbox"/> Hydrology and Water Quality |
| <input type="checkbox"/> Land Use and Planning | <input type="checkbox"/> Mineral Resources | <input checked="" type="checkbox"/> Noise |
| <input type="checkbox"/> Population and Housing | <input type="checkbox"/> Public Services | <input type="checkbox"/> Recreation |
| <input checked="" type="checkbox"/> Transportation/Traffic | <input checked="" type="checkbox"/> Tribal Cultural Resources | <input type="checkbox"/> Utilities and Service Systems |
| <input checked="" type="checkbox"/> Mandatory Findings of Significance | | |

Determination

Based on this initial evaluation:

- I find that the proposed project COULD NOT have a significant effect on the environment, and a NEGATIVE DECLARATION will be prepared.
- I find that although the proposed project could have a significant effect on the environment, there will not be a significant effect in this case because revisions to the project have been made by or agreed to by the project proponent. A MITIGATED NEGATIVE DECLARATION will be prepared.
- I find that the proposed project MAY have a significant effect on the environment, and an ENVIRONMENTAL IMPACT REPORT is required.
- I find that the proposed project MAY have a “potentially significant impact” or “potentially significant unless mitigated” impact on the environment, but at least one effect (1) has been adequately analyzed in an earlier document pursuant to applicable legal standards, and (2) has been addressed by mitigation measures based on the earlier analysis as described on attached sheets. An ENVIRONMENTAL IMPACT REPORT is required, but it must analyze only the effects that remain to be addressed.

City of Hayward
22626 4th Street Residential Project

- I find that although the proposed project could have a significant effect on the environment, because all potential significant effects (a) have been analyzed adequately in an earlier EIR or NEGATIVE DECLARATION pursuant to applicable standards, and (b) have been avoided or mitigated pursuant to that earlier EIR or NEGATIVE DECLARATION, including revisions or mitigation measures that are imposed upon the proposed project, nothing further is required.

Signature

Date

Printed Name

Title

Environmental Checklist

1 Aesthetics

	Potentially Significant Impact	Less than Significant with Mitigation Incorporated	Less than Significant Impact	No Impact
Would the project:				
a. Have a substantial adverse effect on a scenic vista?	<input type="checkbox"/>	<input type="checkbox"/>	<input type="checkbox"/>	<input checked="" type="checkbox"/>
b. Substantially damage scenic resources, including but not limited to, trees, rock outcroppings, and historic buildings within a state scenic highway?	<input type="checkbox"/>	<input type="checkbox"/>	<input type="checkbox"/>	<input checked="" type="checkbox"/>
c. Substantially degrade the existing visual character or quality of the site and its surroundings?	<input type="checkbox"/>	<input type="checkbox"/>	<input checked="" type="checkbox"/>	<input type="checkbox"/>
d. Create a new source of substantial light or glare that would adversely affect daytime or nighttime views in the area?	<input type="checkbox"/>	<input type="checkbox"/>	<input checked="" type="checkbox"/>	<input type="checkbox"/>

a. Would the project have a substantial adverse effect on a scenic vista?

A scenic vista is generally defined as an expansive view of highly valued landscape as observable from a publicly accessible vantage point. The *Hayward 2040 General Plan* characterizes the city’s scenic vistas as views of natural topography, open grassland vegetation, East Bay hills, and the San Francisco Bay shoreline. In addition, portions of I-580, I-880, and State Route 92 (SR 92) in the city are designated as County Scenic Highways. The project site is not part of an identified scenic landscape in the city and is not located in the viewshed of a County Scenic Highway. The project site is relatively flat and in an urban area surrounded by development. None of the significant view areas are located on or near the project site. In addition, there are no scenic views or views of such features as the East Bay hills available from or through the site, due to the distance from such features and the intervening buildings and vegetation. The project will not block significant views or other scenic vistas. No impact will occur.

NO IMPACT

b. Would the project substantially damage scenic resources, including, but not limited to, trees, rock outcroppings, and historic buildings within a state scenic highway?

The closest designated state scenic highway is a portion of I-580 at the northern edge of the city, approximately 0.75 mile north of the project site (California Department of Transportation

City of Hayward
22626 4th Street Residential Project

[Caltrans] 2011). The project site is not visible from I-580 and therefore the project will not damage scenic resources within view of a state scenic highway. No impact will occur.

NO IMPACT

- c. *Would the project substantially degrade the existing visual character or quality of the site and its surroundings?*

The project site is currently undeveloped. The visual character of the site is dominated by the numerous mature trees located on the site and the undeveloped nature of the site in contrast to its surroundings. The site is surrounded on three sides by one- and two-story residential and commercial development with a mix of architectural styles, including Victorian and Craftsman. Construction of the project would substantially alter the visual character of the project site through the removal of mature trees and introduction of 41 single-family residences to a currently vacant and open site. The project elevations and proposed architectural style are illustrated in Figure 6 (Plans 1, 2, and 3) and Figure 7 (Plans 4 and 5). The area surrounding the project site is developed with single-family residences and commercial developments. The scale of the new residences and the single-family detached residence development pattern would be consistent with the height of existing buildings and the development pattern in the surrounding area. Therefore, although the visual character of the site would be altered, it would not be substantially degraded as the project will be compatible with surrounding development and the visual character of the area. Impacts will be less than significant.

LESS THAN SIGNIFICANT IMPACT

- d. *Would the project create a new source of substantial light or glare which would adversely affect day or nighttime views in the area?*

The project site is in an urbanized area with relatively high levels of existing light. The surrounding residential, commercial, and roadway uses generate light and glare. Primary sources of light adjacent to the project site include interior and exterior lighting associated with the existing residential and commercial buildings, vehicle headlights, and street lights. The primary source of glare adjacent to the project site is the sun's reflection from metallic, glass, and light-colored surfaces on buildings and on vehicles parked on adjacent streets and in adjacent parking areas.

The project would introduce new sources of lighting and glare as the project site is currently undeveloped. The project would not include street lights on the private roadway, but the single-family residences would have some exterior lighting to illuminate driveways and yards. The project would also introduce light and glare from headlights of vehicles entering and exiting the project driveways on B Street. Sources of glare associated with the project site include vehicles parked in driveways or in the designated street parking spaces. These sources of light and glare would be similar to existing sources surrounding the site and would be consistent with other uses in the area. No highly reflective glass elements are proposed as part of the project. Therefore, impacts will be less than significant.

LESS THAN SIGNIFICANT IMPACT

2 Agriculture and Forestry Resources

	Potentially Significant Impact	Less than Significant with Mitigation Incorporated	Less than Significant Impact	No Impact
--	--------------------------------	--	------------------------------	-----------

Would the project:

a. Convert Prime Farmland, Unique Farmland, Farmland of Statewide Importance (Farmland), as shown on maps prepared pursuant to the Farmland Mapping and Monitoring Program of the California Resources Agency, to non-agricultural use?	<input type="checkbox"/>	<input type="checkbox"/>	<input type="checkbox"/>	<input checked="" type="checkbox"/>
b. Conflict with existing zoning for agricultural use or a Williamson Act contract?	<input type="checkbox"/>	<input type="checkbox"/>	<input type="checkbox"/>	<input checked="" type="checkbox"/>
c. Conflict with existing zoning for, or cause rezoning of, forest land (as defined in Public Resources Code Section 12220(g)); timberland (as defined by Public Resources Code Section 4526); or timberland zoned Timberland Production (as defined by Government Code Section 51104(g))?	<input type="checkbox"/>	<input type="checkbox"/>	<input type="checkbox"/>	<input checked="" type="checkbox"/>
d. Result in the loss of forest land or conversion of forest land to non-forest use?	<input type="checkbox"/>	<input type="checkbox"/>	<input type="checkbox"/>	<input checked="" type="checkbox"/>
e. Involve other changes in the existing environment which, due to their location or nature, could result in conversion of Farmland to non-agricultural use or conversion of forest land to non-forest use?	<input type="checkbox"/>	<input type="checkbox"/>	<input type="checkbox"/>	<input checked="" type="checkbox"/>

-
- a. *Would the project convert Prime Farmland, Unique Farmland, Farmland of Statewide Importance (Farmland), as shown on the maps prepared pursuant to the Farmland Mapping and Monitoring Program of the California Resources Agency, to non-agricultural use?*
 - b. *Would the project conflict with existing zoning for agricultural use, or a Williamson Act contract?*
 - c. *Would the project conflict with existing zoning for, or cause rezoning of, forest land (as defined in Public Resources Code Section 12220(g)), timberland (as defined by Public Resources Code Section 4526), or timberland zoned Timberland Production (as defined by Government Code Section 51104(g))?*
 - d. *Would the project result in the loss of forest land or conversion of forest land to non-forest use?*

City of Hayward
22626 4th Street Residential Project

- e. *Would the project involve other changes in the existing environment, which, due to their location or nature, could result in conversion of Farmland to non-agricultural use?*

The project site is located in an urbanized area of Hayward. The site is designated as LDR (Low Density Residential) and MDR (Medium Density Residential) in the City's General Plan and zoned RS (Single Family Residential) in the municipal code. Neither the project site nor adjacent properties are identified as any farmland type under the Farmland Mapping and Monitoring Program or enrolled in Williamson Act contracts, or support forest land or resources (California Department of Conservation 2016). The project site is not located on or adjacent to agricultural land or forest land and the project would not involve any development that could result in the conversion of farmland to non-agricultural uses. For these reasons, the project will have no impact with respect to conversion of Prime Farmland, Unique Farmland, or Farmland of Statewide Importance to non-agricultural use; conflict with existing agricultural zoning or Williamson Act contract; result in the loss of forest land or conversion of forest land to non-forest use; or other conversion of farmland to non-agricultural use.

NO IMPACT

3 Air Quality

	Potentially Significant Impact	Less than Significant with Mitigation Incorporated	Less than Significant Impact	No Impact
Would the project:				
a. Conflict with or obstruct implementation of the applicable air quality plan?	<input type="checkbox"/>	<input type="checkbox"/>	<input checked="" type="checkbox"/>	<input type="checkbox"/>
b. Violate any air quality standard or contribute substantially to an existing or projected air quality violation?	<input type="checkbox"/>	<input type="checkbox"/>	<input checked="" type="checkbox"/>	<input type="checkbox"/>
c. Result in a cumulatively considerable net increase of any criteria pollutant for which the project region is non-attainment under an applicable federal or state ambient air quality standard (including releasing emissions which exceed quantitative thresholds for ozone precursors)?	<input type="checkbox"/>	<input type="checkbox"/>	<input checked="" type="checkbox"/>	<input type="checkbox"/>
d. Expose sensitive receptors to substantial pollutant concentrations?	<input type="checkbox"/>	<input type="checkbox"/>	<input checked="" type="checkbox"/>	<input type="checkbox"/>
e. Create objectionable odors affecting a substantial number of people?	<input type="checkbox"/>	<input type="checkbox"/>	<input checked="" type="checkbox"/>	<input type="checkbox"/>

Air Quality Standards and Attainment

The project site is located in the San Francisco Bay Area Air Basin (the Basin), which is under the jurisdiction of the Bay Area Air Quality Management District (BAAQMD). As the local air quality management agency, the BAAQMD is required to monitor air pollutant levels to ensure that state and federal air quality standards are met and, if they are not met, to develop strategies to meet the standards.

Depending on whether or not the standards are met or exceeded, the Basin is classified as being in "attainment" or "nonattainment." Under state law, air districts are required to prepare a plan for air quality improvement for pollutants for which the district is in non-compliance. The BAAQMD is in non-attainment for the state and federal ozone standards, the state and federal particulate matter up to 2.5 microns in diameter (PM_{2.5}) standards, and the state particulate matter up to 10 microns in diameter (PM₁₀) standard and is required to prepare a plan for improvement (BAAQMD 2017a).

The health effects associated with criteria pollutants for which the Basin is in non-attainment are described in Table 2.

Table 2 Health Effects Associated with Non-Attainment Criteria Pollutants

Pollutant	Adverse Effects
Ozone	(1) Short-term exposures: (a) pulmonary function decrements and localized lung edema in humans and animals and (b) risk to public health implied by alterations in pulmonary morphology and host defense in animals; (2) long-term exposures: risk to public health implied by altered connective tissue metabolism and altered pulmonary morphology in animals after long-term exposures and pulmonary function decrements in chronically exposed humans; (3) vegetation damage; and (4) property damage.
Suspended particulate matter (PM ₁₀)	(1) Excess deaths from short-term and long-term exposures; (2) excess seasonal declines in pulmonary function, especially in children; (3) asthma exacerbation and possibly induction; (4) adverse birth outcomes including low birth weight; (5) increased infant mortality; (6) increased respiratory symptoms in children such as cough and bronchitis; and (7) increased hospitalization for both cardiovascular and respiratory disease (including asthma). ^a
Suspended particulate matter (PM _{2.5})	(1) Excess deaths from short- and long-term exposures; (2) excess seasonal declines in pulmonary function, especially in children; (3) asthma exacerbation and possibly induction; (4) adverse birth outcomes, including low birth weight; (5) increased infant mortality; (6) increased respiratory symptoms in children, such as cough and bronchitis; and (7) increased hospitalization for both cardiovascular and respiratory disease, including asthma. ¹

¹ More detailed discussions on the health effects associated with exposure to suspended particulate matter can be found in the following documents: EPA, *Air Quality Criteria for Particulate Matter*, October 2004.

Source: U.S. EPA, <http://www.epa.gov/airquality/urbanair/>

Air Quality Management

The Bay Area 2017 Clean Air Plan (Plan) provides a plan to improve Bay Area air quality and protect public health as well as the climate. The legal impetus for the Plan is to update the most recent ozone plan, the 2010 Clean Air Plan, to comply with state air quality planning requirements as codified in the California Health & Safety Code. Although steady progress has been made to reduce ozone levels in the Bay Area, the region continues to be designated as non-attainment for both the one-hour and eight-hour state ozone standards as noted previously. In addition, emissions of ozone precursors in the Bay Area contribute to air quality problems in neighboring air basins. Under these circumstances, state law requires the Clean Air Plan to include all feasible measures to reduce emissions of ozone precursors and reduce transport of ozone precursors to neighboring air basins (BAAQMD 2017b).

In 2006, the U.S. Environmental Protection Agency (US EPA) tightened the national 24-hour PM_{2.5} standard regarding short-term exposure to fine particulate matter from 65 µg/m³ (micro-grams per cubic meter) to 35 µg/m³. Based on air quality monitoring data for years 2006 to 2008 showing that the region was slightly above the standard, the US EPA designated the Bay Area as non-attainment for the 24-hour national standard in December 2008. This triggered the requirement for the Bay Area to prepare a State Implementation Plan (SIP) submittal to demonstrate how the region would attain the standard. However, data for both the 2008–2010 and the 2009–2011 cycles showed that Bay Area PM_{2.5} levels currently meet the standard. On October 29, 2012, the US EPA issued a proposed rule-making to determine that the Bay Area now attains the 24-hour PM_{2.5} national standard. Based on this, the Bay Area is required to prepare an abbreviated SIP submittal that includes an emission inventory for primary (directly emitted) PM_{2.5}, as well as precursor pollutants

that contribute to formation of secondary PM in the atmosphere; and amendments to the BAAQMD New Source Review (NSR) to address PM_{2.5} (adopted December 2012).² However, key SIP requirements to demonstrate how a region will achieve the standard (i.e., the requirement to develop a plan to attain the standard) will be suspended as long as monitoring data continues to show that the Bay Area attains the standard.

In addition to preparing the “abbreviated” SIP submittal, the BAAQMD has prepared a report entitled *Understanding Particulate Matter: Protecting Public Health in the San Francisco Bay Area* (BAAQMD 2012). The report will help to guide the BAAQMD’s ongoing efforts to analyze and reduce PM in the Bay Area in order to better protect public health. The Bay Area will continue to be designated as “non-attainment” for the national 24-hour PM_{2.5} standard until such time as the Air District elects to submit a “redesignation request” and a “maintenance plan” to the US EPA and the US EPA approves the proposed redesignation.

Air Emission Thresholds

This analysis uses the BAAQMD’s May 2017 *California Environmental Quality Act (CEQA) Air Quality Guidelines* to evaluate air quality. The May 2017 Guidelines include revisions made to the 2010 Guidelines, addressing the California Supreme Court’s 2015 opinion in the *Cal. Bldg. Indus. Ass’n vs. Bay Area Air Quality Mgmt. Dist.*, 62 Cal. 4th 369 (BAAQMD 2017c). Table 3 presents the numeric significance thresholds for construction and operational-related criteria air pollutant and precursor emissions in the May 2017 BAAQMD CEQA Air Quality Thresholds. These represent the levels at which a project’s individual emissions of criteria air pollutants or precursors would result in a cumulatively considerable contribution to the Basin’s existing air quality conditions.

Table 3 Air Quality Thresholds of Significance

Pollutant/ Precursor	Construction-Related Thresholds		Operation-Related Thresholds	
	Average Daily Emissions (pounds per day)	Maximum Annual Emissions (tpy)	Maximum Annual Emissions (tpy)	Average Daily Emissions (lbs/day)
ROG	54	10	10	54
NO _x	54	10	10	54
PM ₁₀	82 (exhaust)	15	15	82
PM _{2.5}	54 (exhaust)	10	10	54

Notes: tpy = tons per year; lbs/day = pounds per day; NO_x = oxides of nitrogen; PM_{2.5} = fine particulate matter with an aerodynamic resistance diameter of 2.5 micrometers or less; PM₁₀ = respirable particulate matter with an aerodynamic resistance diameter of 10 micrometers or less; ROG = reactive organic gases; tpy = tons per year.

Source: Table 2-1, Bay Area Air Quality Management District, CEQA Air Quality Guidelines, May 2017.

The BAAQMD has developed screening criteria to provide lead agencies and project applicants with a conservative indication of whether a project could result in potentially significant air quality impacts. If all of the screening criteria are met by a project, then the lead agency or applicant would not need to perform a detailed air quality assessment of their project’s air pollutant emissions.

² PM is made up of particles that are emitted directly, such as soot and fugitive dust, as well as secondary particles that are formed in the atmosphere from chemical reactions involving precursor pollutants such as oxides of nitrogen (NO_x), sulfur oxides (SO_x), volatile organic compounds (VOC), and ammonia (NH₃).

City of Hayward
22626 4th Street Residential Project

These screening levels are generally representative of new development on greenfield sites without any form of mitigation measures taken into consideration. For projects that are infill, such as the proposed project, emissions would be less than the greenfield-type project on which the screening criteria are based (BAAQMD 2017c). For single-family residences, the BAAQMD's operational criteria pollutant screening size is 325 dwelling units and the construction-related screening size is 114 dwelling units. The proposed project involves 41 dwelling units and is well below the screening criteria.

Impact Analysis

a. Would the project conflict with or obstruct implementation of the applicable air quality plan?

Vehicle use, energy consumption, and associated air pollutant emissions are directly related to population and housing growth. A project may be inconsistent with the applicable air quality plan if it would result in population, housing, or employment growth that exceeds growth estimates included in the plan. Such growth would generate emissions not accounted for in the applicable air quality plan emissions budget. Therefore, projects need to be evaluated to determine whether they would generate population, housing, or employment growth and, if so, whether that growth would exceed the growth rates included in the applicable air quality plan. The most recent and applicable adopted air quality plan is the 2017 Clean Air Plan. Therefore, the proposed project would result in a significant impact if it would conflict with or obstruct implementation of the 2017 Plan.

The BAAQMD uses the Association of Bay Area Government's (ABAG) growth forecast. The latest ABAG projections do not include a population forecast but do provide a housing forecast. ABAG estimates that the number of housing units in the city in 2040 will be 54,300 (ABAG 2017a). The California Department of Finance (DOF) estimates the city currently has 49,665 housing units (DOF 2017). Therefore, the addition of 41 housing units associated with the proposed project would bring the City's total housing units to 49,706. The housing growth associated with the project would be well within ABAG projections and therefore also within the BAAQMD Clean Air Plan projections.

Further, as discussed in responses to questions (b) and (c) below and in Section 7, *Greenhouse Gas Emissions*, the project not would exceed BAAQMD significance thresholds related to air quality or GHG emissions. Therefore, the project will not conflict with or obstruct the implementation of an applicable air quality plan. This impact will be less than significant.

LESS THAN SIGNIFICANT IMPACT

b. Would the project violate any air quality standard or contribute substantially to an existing or projected air quality violation?

c. Would the project result in a cumulatively considerable net increase of any criteria pollutant for which the project region is non-attainment under an applicable federal or state ambient air quality standard (including releasing emissions that exceed quantitative thresholds for ozone precursors)?

Construction of the project would result in temporary construction emissions and long-term operational emissions. Construction activities such as the operation of construction vehicles and equipment over unpaved areas, grading, trenching, and disturbance of stockpiled soils have the potential to generate fugitive dust (PM₁₀) through the exposure of soil to wind erosion and dust entrainment. In addition, exhaust emissions associated with heavy construction equipment would potentially degrade regional air quality.

Long-term emissions associated with operational impacts would include emissions from vehicle trips (mobile sources), natural gas and electricity use (energy sources), and landscape maintenance equipment, consumer products, and architectural coating associated with on-site development (area sources).

The BAAQMD developed screening criteria to provide lead agencies and project applicants with a conservative indication of whether a project could result in potentially significant air quality impacts. If all of the screening criteria are met by a project, then the lead agency or applicant would not need to perform a detailed air quality assessment of their project's air pollutant emissions. These screening levels are generally representative of new development on greenfield sites without any form of mitigation measures taken into consideration. For projects that are infill, such as the project, emissions would be less than the greenfield-type project on which the screening criteria are based (BAAQMD 2017c).

The BAAQMD's construction-related screening level for single-family residential operations is 114 dwelling units. For operational emissions, the minimum screening level is 325 dwelling units (BAAQMD 2017c). The project would involve the construction of 41 dwelling units. Therefore, the project would be below the construction and operational screening level criteria for single-family land use. According to BAAQMD, if all of the screening criteria are met by a project, then the lead agency or applicant would not need to perform a detailed air quality assessment of their project's air pollutant emissions. Since the screening criteria are met, the project would not exceed any BAAQMD air pollutant thresholds. The project would not violate an air quality standard or contribute to an existing or projected air quality violation.

As noted above, the Basin is currently nonattainment for the federal and state standards for ozone, as well as state standards for particulate matter ($PM_{2.5}$ and PM_{10}) and the federal standard for 24-hour $PM_{2.5}$. According to BAAQMD, if a project meets the screening criteria, the project would result in a less-than-significant cumulative impact to air quality from criteria air pollutant and precursor emissions. Since the project is below the operational screening level thresholds, cumulative impacts for criteria pollutants will be less than significant.

LESS THAN SIGNIFICANT IMPACT

d. Would the project expose sensitive receptors to substantial pollutant concentrations?

The California Air Resources Board (CARB) has identified diesel particulate matter as the primary airborne carcinogen in the state (CARB 2014). In addition, Toxic Air Contaminants (TAC) are a defined set of air pollutants that may pose a present or potential hazard to human health. Common sources of TACs and $PM_{2.5}$ include gasoline stations, dry cleaners, diesel backup generators, truck distribution centers, freeways, and other major roadways (BAAQMD 2017c).

The project does not include construction of new gas stations, dry cleaners, highways, major roadways, or other sources that could be considered new permitted or non-permitted source of TAC or $PM_{2.5}$ in proximity to receptors. Although the project would involve development of new private roadways to provide site circulation, these private roadways would only serve project residents and guests and would not have high enough vehicle traffic to be considered a new source of TAC or $PM_{2.5}$. In addition, the project would not introduce a new stationary source of emissions and would not result in particulate matter greater than BAAQMD thresholds (see response under questions a, b, and c). Therefore, a Health Risk Assessment was not performed for this project. Impacts under this criterion will be less than significant.

LESS THAN SIGNIFICANT IMPACT

City of Hayward
22626 4th Street Residential Project

e. Would the project create objectionable odors affecting a substantial number of people?

Table 3-3 in the BAAQMD's 2017 CEQA Guidelines provides odor screening distances for land uses that have the potential to generate substantial odor complaints. The uses in the table include wastewater treatment plants, landfills or transfer stations, refineries, composting facilities, confined animal facilities, food manufacturing, smelting plants, and chemical plants (BAAQMD 2017c). The proposed project involves residential uses. None of the uses identified in the table would occur with the project. The proposed project would not generate objectionable odors affecting a substantial number of people during operation.

During construction activities, heavy equipment and vehicles would emit odors associated with vehicle and engine exhaust both during normal use and when idling. However, these odors would be temporary and would cease upon completion. Overall, the proposed project would not generate objectionable odors affecting a substantial number of people. This impact will be less than significant.

LESS THAN SIGNIFICANT IMPACT

4 Biological Resources

	Potentially Significant Impact	Less than Significant with Mitigation Incorporated	Less than Significant Impact	No Impact
--	--------------------------------	--	------------------------------	-----------

Would the project:

a. Have a substantial adverse effect, either directly or through habitat modifications, on any species identified as a candidate, sensitive, or special status species in local or regional plans, policies, or regulations, or by the California Department of Fish and Wildlife or U.S. Fish and Wildlife Service?	<input type="checkbox"/>	<input checked="" type="checkbox"/>	<input type="checkbox"/>	<input type="checkbox"/>
b. Have a substantial adverse effect on any riparian habitat or other sensitive natural community identified in local or regional plans, policies, or regulations, or by the California Department of Fish and Wildlife or U.S. Fish and Wildlife Service?	<input type="checkbox"/>	<input checked="" type="checkbox"/>	<input type="checkbox"/>	<input type="checkbox"/>
c. Have a substantial adverse effect on federally protected wetlands as defined by Section 404 of the Clean Water Act (including, but not limited to, marsh, vernal pool, coastal, etc.) through direct removal, filling, hydrological interruption, or other means?	<input type="checkbox"/>	<input checked="" type="checkbox"/>	<input type="checkbox"/>	<input type="checkbox"/>
d. Interfere substantially with the movement of any native resident or migratory fish or wildlife species or with established native resident or migratory wildlife corridors, or impede the use of native wildlife nursery sites?	<input type="checkbox"/>	<input checked="" type="checkbox"/>	<input type="checkbox"/>	<input type="checkbox"/>
e. Conflict with any local policies or ordinances protecting biological resources, such as a tree preservation policy or ordinance?	<input type="checkbox"/>	<input checked="" type="checkbox"/>	<input type="checkbox"/>	<input type="checkbox"/>
f. Conflict with the provisions of an adopted Habitat Conservation Plan, Natural Community Conservation Plan, or other approved local, regional, or state habitat conservation plan?	<input type="checkbox"/>	<input type="checkbox"/>	<input type="checkbox"/>	<input checked="" type="checkbox"/>

Existing Setting

San Lorenzo Creek, which flows in an east-to-west direction, runs adjacent to the northern boundary of the project site and crosses the site in the northwest corner. As shown in Figure 2, the northwestern boundary of the project site extends to the A Street Bridge and encompasses approximately 100 feet of the creek. The remainder of the northern boundary of the project site extends close to the top of the southern bank. Approximately 650 feet to the west of the site is De Anza Park, which is an open space area consisting of a small wooded area and a pedestrian trail.

The project site currently comprises undeveloped and disturbed vacant land with gravel, rubble piles, bare earth, ruderal non-native species, and mature trees on relatively level topography that ranges in elevation from 105 feet to 140 feet above mean sea level. The site gently slopes downward from east to west. In the northwest corner, the site slopes down approximately 10 feet into San Lorenzo Creek. The lowest point of the project site is in the San Lorenzo Creek streambed adjacent to the A Street Bridge in the northwest corner. As recent as 2017, the site contained residential development, which has since been demolished and replaced with ruderal vegetation.

Information contained in this section comes from background literature, resource agency database reviews, and from a survey of the project site conducted by Rincon Consultants, Inc. in January 2018.

Regulatory Setting

Federal and State

Regulatory authority over biological resources is shared by federal, state, and local agencies under a variety of laws, ordinances, regulations, and statutes. Primary authority for biological resources lies within the land use control and planning authority of local jurisdictions (in this instance, the City of Hayward).

The California Department of Fish and Wildlife (CDFW) is a trustee agency for biological resources throughout the state under CEQA and has direct jurisdiction under the California Fish and Game Code (CFGF). Under the California Endangered Species Act (CESA) and the federal Endangered Species Act (ESA), the CDFW and the U.S. Fish and Wildlife Service (USFWS), respectively, have direct regulatory authority over species formally listed as threatened or endangered (and listed as rare for CDFW). Native and/or migratory bird species are protected under the federal Migratory Bird Treaty Act (MBTA) and CFGF Sections 3503, 3503.5, and 3511.

Statutes in the Clean Water Act (CWA), CFGF, and the California Code of Regulations (CCR) protect wetlands and riparian habitat. The U.S. Army Corps of Engineers (USACE) has regulatory authority over wetlands and waters of the United States under Section 404 of the CWA. The State Water Resources Control Board (SWRCB) and the nine Regional Water Quality Control Boards (RWQCB) ensure water quality protection in California pursuant to Section 401 of the CWA and Section 13263 of the Porter-Cologne Water Quality Control Act. The CDFW regulates Waters of the State under the CFGF Section 1600 et seq.

Special-status species are those plants and animals 1) listed, proposed for listing, or candidates for listing as Threatened or Endangered by the USFWS and the National Marine Fisheries Service (NMFS) under ESA; 2) listed or proposed for listing as Rare, Threatened, or Endangered by the CDFW under CESA; 3) recognized as California Species of Special Concern (CSSC) by the CDFW; 4) afforded protection under MBTA or CFGF; and 5) occurring on Lists 1 and 2 of the CDFW California Rare Plant Rank (CRPR) system.

City of Hayward

The City of Hayward Municipal Code (HMC) Chapter 10, Article 15, Tree Preservation, requires a permit for the removal, destruction, or cutting of branches over one inch in diameter, or disfigurement of any Protected Tree. It also requires that all removed or disfigured trees be replaced with like-size, like-kind trees or equivalent value of trees as determined by the City's landscape architect. Protected trees are defined as follows:

- Trees having a minimum trunk diameter of eight inches measured 54 inches above the ground. When measuring a multi-trunk tree, the diameters of the largest three trunks shall be added together.
- Street trees or other required trees such as those required as a condition of approval, Use Permit, or other Zoning requirement, regardless of size.
- All memorial trees dedicated by an entity recognized by the City, and all specimen trees that define a neighborhood or community.
- Trees of the following species that have reached a minimum of four inches diameter trunk size:
 - Big leaf maple (*Acer macrophyllum*)
 - California buckeye (*Aesculus californica*)
 - Madrone (*Arbutus menziesii*)
 - Western dogwood (*Cornus nuttallii*)
 - California sycamore (*Platanus racemosa*)
 - Coast live oak (*Quercus agrifolia*)
 - Canyon live oak (*Quercus chrysolepis*)
 - Blue oak (*Quercus douglasii*)
 - Oregon white oak (*Quercus garryana*)
 - California black oak (*Quercus kelloggii*)
 - Valley oak (*Quercus lobata*)
 - Interior live oak (*Quercus wislizenii*)
 - California bay (*Umbellularia californica*)
- A tree or trees of any size planted as a replacement for a Protected Tree.

Additional conditions of approval under the HMC may include, but are not limited to the following:

- Monitoring of all pruning (including roots), trimming or relocation of protected trees by a certified arborist
- Root zone protection measures including non-movable fencing to establish and maintain protection zones prior to and through completion of construction
- Maintenance of protected trees throughout construction

Assessment Methodology and Results

Literature Review

Rincon Consultants, Inc. (Rincon) reviewed relevant databases and literature for baseline information on biological resources occurring and potentially occurring at the project site and in the immediate surrounding area. The review included the following sources:

City of Hayward
22626 4th Street Residential Project

- U.S. Department of Agriculture, Natural Resources Conservation Service Web Soil Survey (NRCS 2018);
- CDFW California Natural Diversity Database (CNDDDB) for the Novato and Petaluma River, California USGS 7.5-minute quadrangles (CDFW 2018a);
- California Native Plant Society (CNPS) Online Inventory of Rare and Endangered Plants of California for the Hayward, California and eight surrounding USGS 7.5-minute quadrangles (CNPS 2018);
- Consortium of California Herbaria (CCH, 2018);
- USFWS Information for Planning and Consultation (IPaC) search (USFWS 2018a), and Critical Habitat Portal (USFWS 2018b)
- USFWS National Wetlands Inventory database (USFWS 2018c); and
- Aerial photographs (Google Earth 2018).

Rincon biologists conducted a review of the CNDDDB (CDFW 2018a) for recorded occurrences of special-status plant and wildlife species in the region prior to conducting a reconnaissance-level field survey. The CNDDDB query included records from the *Hayward, California* USGS 7.5-minute topographic quadrangle containing the project site and the eight surrounding quadrangles: *Dublin, Niles, Newark, Redwood Point, San Leandro, Oakland East, Las Trampas Ridge, and Diablo, California*. The CNDDDB is based on reported occurrences of special-status taxa and does not constitute a comprehensive inventory of biological resources for any given area.

Other database search results included the CNPS Online Inventory of Rare and Endangered Plants of California (CNPS 2018) and USFWS IPaC (2018a). Rincon biologists also supplemented these data with experience and knowledge of the region. Rincon compiled these sources into a list of regionally occurring special-status plants and animals, and evaluated each species for potential to occur based on habitat conditions and proximity to known occurrences. Rincon also reviewed the National Wetlands Inventory (USFWS 2018c).

The United States Department of Agriculture Natural Resources Conservation Service (NRCS 2018) soil map depicts two soil map units: Botella loam with zero to two percent slopes (MLRA 14) and Danville silty clay loam with zero to two percent slopes. The Botella loam complex is a well-drained, fine loamy soil that supports low runoff and is derived from sedimentary rock alluvium (NRCS 2018).

Rincon reviewed the arborist report prepared in support of project permitting by HortScience, Inc. (Appendix A). The arborist report identified and assessed 109 trees on and directly adjacent to the project site, representing 27 species. The trees identified are typical of those found in Bay Area landscaping. The most prevalent tree species was coast live oak (*Quercus agrifolia*), of which there were 28 individuals. Trees were reported to not be well maintained but primarily in good health, with 16 trees in poor condition, 71 in fair condition, and 22 in good condition. Additional details of the tree species identified and the condition of each tree can be found in the above-referenced arborist report (Appendix A).

Biological Surveys and Results

On January 7, 2018, a Rincon biologist conducted a biological resources assessment survey of the project site to determine the potential presence of sensitive vegetation types, aquatic communities (e.g., wetlands), and special-status plant and wildlife species present or potentially present on the project site. During the survey, the project site was examined for (1) the potential to support special-status plant and wildlife species, (2) the potential presence of sensitive biological

communities such as wetlands or riparian habitats, and (3) the potential presence of other sensitive biological resources protected by local, state, and federal laws and regulations.

The project site primarily consists of non-native grassland with a variety of native and non-native trees scattered throughout. The site is entirely ruderal having historically been developed with several small single-family residences. All buildings on the site were demolished and removed as recently as early 2017. Patches of nearly bare ground remain in places where house foundations or paved driveways once stood.

Plant species identified on-site include those typical of ruderal vegetation communities in urban settings in the East Bay Area and consisted entirely of non-native species (Table 4). The site was dominated by annual grasses with approximately ninety percent cover. The remaining ten percent consisted of few herbaceous and shrub species intermixed throughout the site and small patches of bare ground. Numerous trees were presented and are inventoried in the arborist report prepared by HortScience, Inc. (2017).

Few animal species were observed on the project site during the site visit and consisted of typical species for an urban setting in the East Bay Area. Species observed included turkey (*Meleagris gallopavo*), white-crowned sparrow (*Zonotrichia leucophrys*), California scrub-jay (*Aphelocoma californica*), dark-eyed junco (*Junco hyemalis*), turkey vulture (*Cathartes aura*), and red-shouldered hawk (*Buteo lineatus*). The project site provides little to no habitat for the majority of animals that could be present in the area given its recent history of disturbance and location in a heavily developed urban setting. However, nesting opportunities for birds are abundant and a single, inactive nest was observed in a large eucalyptus (*Eucalyptus* sp.) tree off-site to the northeast. Characteristics of the nest were consistent with a raptor nest. The single red-shouldered hawk observed during the site visit was perched in a eucalyptus tree to the west of the site along San Lorenzo Creek and was displaying courting calls.

Table 4 Plant Species Observed on the Project Site

Scientific name	Common Name	Origin
<i>Acacia melanoxylon</i>	acacia	Introduced; Cal-IPC Limited
<i>Amaryllis belladonna</i>	Belladonna lily	Introduced
<i>Brassica nigra</i>	Black mustard	Introduced; Cal-IPC Moderate
<i>Centranthus ruber</i>	red valerian	Introduced
<i>Conium maculatum</i>	poison hemlock	Introduced; Cal-IPC Moderate
<i>Erodium moschatum</i>	green stem filaree	Introduced
<i>Eucalyptus polyanthemos</i>	silver dollar gum	Introduced
<i>evFoeniculum vulgare</i>	fennel	Introduced; Cal-IPC Moderate
<i>Geranium dissectum</i>	cut-leaf geranium	Introduced; Cal-IPC Limited
<i>Hedera helix</i>	English Ivy	Introduced; Cal-IPC High
<i>Helminthotheca echioides</i>	bristly ox tongue	Introduced; Cal-IPC Limited
<i>Lysimachia arvensis</i>	scarlet pimpernel	Introduced
<i>Malva sp.</i>	cheeseweed or bull mallow	Introduced
<i>Medicago polymorpha</i>	bur clover	Introduced; Cal-IPC Limited
<i>Opuntia ficus-indica</i>	prickly pear	Introduced
<i>Oxalis pes-caprae</i>	Bermuda buttercup	Introduced; Cal-IPC Moderate
<i>Phoenix sp.</i>	palm	Introduced
<i>Poa annua</i>	annual bluegrass	Introduced
<i>Poaceae multiple species</i>	annual grasses	Introduced
<i>Rubus armeniacus</i>	Himalayan blackberry	Introduced; Cal-IPC High
<i>Senecio vulgaris</i>	common groundsel	Introduced
<i>Silybum marianum</i>	milk thistle	Introduced; Cal-IPC Limited
<i>Sonchus oleraceus</i>	common sow thistle	Introduced
<i>Stipa mileacea</i>	smilo grass	Introduced; Cal-IPC Limited

Impact Analysis

- a. *Would the project have a substantial adverse effect, either directly or through habitat modifications, on any species identified as candidate, sensitive, or special status in local or regional plans, policies, or regulations, or by the California Department of Fish and Wildlife or the U.S. Fish and Wildlife Service?*

Based on the database and literature review conducted for the project, 63 special-status plant species and 44 special-status animal species have been previously documented in the regional vicinity of the project site.

Special-status Plants

No special-status plants were observed on the project site during the reconnaissance survey. Seasonal timing for observing plants in bloom was too early for most plant species; however, no habitat for special-status species was present and the recent historical disturbance of the site along with the observation that few native plant species (no native grasses, shrubs, or herbaceous species;

only four native of 109 tree species) were growing on the site suggests that special-status plant species are not expected to occur.

Special-status Wildlife

No special-status wildlife species were observed on the project site during the reconnaissance survey other than bird species covered under the MBTA and CFGC. Given the recently disturbed condition of the site and location in a heavily developed urban environment, habitat is only present for nesting birds and no potential exists for other special-status species to occur. The presence of San Lorenzo Creek directly adjacent to the site suggests that amphibian species could be present. However, the banks of the channel adjacent to the site are very steep (greater than 45 degrees) and amphibian species are not expected to use the site as upland dispersal habitat. Mitigation Measures BIO-1 and BIO-2, below, are required to avoid indirect impacts to riparian habitat and wildlife species in San Lorenzo Creek.

San Lorenzo Creek provides a wildlife movement corridor through the otherwise heavily developed urban landscape and the presence of vegetation, including large trees, along the creek provides abundant nesting opportunities for resident and migratory birds. A number of large trees are also present on the project site and on properties adjacent to the project site. An inactive nest was observed in a large eucalyptus tree on the property at the end of Chestnut Street off the northeast corner of project site. A single red-shouldered hawk was observed perched in a eucalyptus tree along San Lorenzo Creek at the northeast corner of the project site. The hawk was calling frequently, but no other red-shouldered hawk was observed at the time of the reconnaissance survey and no nesting behavior was observed.

Native bird nests are protected by CFGC Section 3503 and the MBTA. The nesting season generally extends from February through August in California but can vary based upon annual climatic conditions. Thus, construction activities could result in impacts to birds or their nests as the result of tree removal, or disturbance related nest abandonment. Impacts to these species and nesting birds would be potentially significant. However, potential impacts to migratory nesting birds will be reduced to less than significant levels with implementation of Mitigation Measure BIO-1.

Mitigation Measure

The following mitigation measures would be required to avoid or reduce the project's potentially significant impacts to riparian habitat, nesting birds, or special-status wildlife.

- BIO-1** **Invasive Weed Prevention.** All efforts shall be made to avoid the spread or introduction of invasive weeds during construction and operation of the project. Appropriate best management practices that are intended and designed to curtail the spread of invasive plant species shall be implemented during construction, and operational practices shall be incorporated into the Homeowner's Association (HOA) CC&Rs. These include the following:
- During construction, the project shall limit the use of imported soils for fill. Soils currently existing on site shall be used to the extent possible for fill material. If the use of imported fill material is necessary, the imported material shall be obtained from a source that is known to be free of invasive plant species.
 - Equipment and vehicles shall be free of caked on mud and weed seeds/propagules before accessing the project site.

- As the site already contains invasive species (rated by the California Invasive Plant Council [Cal-IPC]), all equipment and vehicles shall be free of caked on mud and weed seeds/propagules before leaving the project site.
- Landscaping materials and plants for lots adjacent to the creek corridor shall not include invasive, non-native ornamentals as identified by the Cal-IPC Inventory. This requirement shall be included in the CC&Rs.
- Use of herbicides and other plant pesticides shall be prohibited during construction and for the duration of operation of the residential community. This requirement shall be included in the CC&Rs.

BIO-2 Designated No-Access Area. To prevent impacts to San Lorenzo Creek during construction or operation of the project, no work or general access shall be permitted along the top of bank of San Lorenzo Creek beyond the designated six-foot wood fence along the property boundary.

- Updated site plans shall be provided prior to issuance of a grading permit that clearly indicate the property limits, the distance of the six-foot wood fence setback from the measured top of bank of San Lorenzo Creek, and the designated “no access” area between the six-foot wood fence and the top of bank of San Lorenzo Creek.
- Posted “no access” signs shall be placed along the six-foot wood fence and along the bank of San Lorenzo Creek at the intersection of A Street and 4th Street to prevent access along the top of bank along San Lorenzo Creek.
- All “no access” signage shall be permanent, and the no access zone shall be described in the CC&Rs.

BIO-3 San Lorenzo Creek Avoidance. No activities associated with project implementation shall result in cut, fill, erosion, sedimentation, or other impacts to San Lorenzo Creek or bank or any modification to the top of bank of San Lorenzo Creek.

If it is not possible to avoid impacts to San Lorenzo Creek as outlined above, a jurisdictional delineation study shall be conducted by a qualified wetlands biologist prior to any project ground breaking and a determination of USACE, RWQCB, and/or CDFW jurisdiction shall be obtained. If any of the above agencies is determined to have jurisdiction of San Lorenzo Creek, permits shall be obtained from the relevant agency prior to any project ground breaking and shall be provided to the City of Hayward to demonstrate compliance with CWA and CFGC.

BIO-4 Nesting Bird Avoidance and Minimization Efforts. If project construction activities occur between February 15 and August 31, a qualified biologist shall conduct a pre-construction survey for nesting birds no more than 14 days prior to construction. The survey shall include the entire project site and a 300-foot buffer to account for nesting raptors. If nests are found, the qualified biologist shall establish an appropriate species-specific avoidance buffer of sufficient size to prevent disturbance by project activity to the nest (up to 300 feet for raptors, up to 150 feet for all other birds). The qualified biologist shall perform at least two hours of pre-construction monitoring of the nest to characterize "typical" bird behavior.

During construction, if active nests are present, the qualified biologist shall monitor the nesting birds to determine if construction activities are causing any disturbance

to the bird, and shall increase the buffer if it is determined the birds are showing signs of unusual or distressed behavior associated with project activities. Atypical nesting behaviors that may cause reproductive harm include, but are not limited to, defensive flights, vocalizations directed towards project personnel/activities, standing up from a brooding position, and flying away from the nest. The qualified biologist shall have authority, through the resident engineer, to order the cessation of all project activities if the nesting birds exhibit atypical behavior that may cause reproductive failure (i.e., nest abandonment and loss of eggs and/or young) until a refined appropriate buffer is established. To prevent encroachment, the established buffer(s) should be clearly marked by high visibility material. The established buffer(s) should remain in effect until the young have fledged or the nest has been abandoned as confirmed by the qualified biologist. Any sign of nest abandonment should be reported to the City and CDFW within 48 hours. The monitoring biologist, in consultation with the resident engineer and project manager shall determine the appropriate protection for active nests on a case by case basis using the criteria described above.

With implementation of the above measures, impacts related to riparian habitat, nesting birds, and special-status wildlife will be less than significant.

LESS THAN SIGNIFICANT WITH MITIGATION INCORPORATED

- b. Would the project have a substantial adverse effect on any riparian habitat or other sensitive natural community identified in local or regional plans, policies, or regulations, or by the California Department of Fish and Wildlife or U.S. Fish and Wildlife Service?*

San Lorenzo Creek crosses the northern boundary of the project site and disturbed riparian vegetation community occurs along its banks. Portions of the creek channel near A Street and along the south bank adjacent to the project site have historically been lined with concrete to reinforce the banks and the development has resulted in considerable disturbance to the creek channel and surrounding vegetation. The riparian community is in poor condition and consists almost entirely of non-native vegetation regrowth, with the only native vegetation consisting of two California bay (*Umbellularia californica*) trees. Despite the very low presence of native vegetation, the vegetation that is present functionally serves as a riparian corridor for wildlife, providing nesting opportunities for native and migratory birds, and movement and dispersal through the urban environment for other wildlife. Project site plans call for an approximately 15-foot setback from the current property fence line. However, implementation of mitigation measures BIO-2 and BIO-3 would ensure that vegetation along San Lorenzo Creek would not be impacted by construction or operation of the project. Therefore, impacts will be less than significant with mitigation.

LESS THAN SIGNIFICANT WITH MITIGATION INCORPORATED

- c. Would the project have a substantial adverse effect on federally protected wetlands as defined by Section 404 of the Clean Water Act (including, but not limited to, marsh, vernal pool, coastal, etc.) through direct removal, filling, hydrological interruption, or other means?*

San Lorenzo Creek is designated as a forested, seasonally flooded palustrine system (USFWS 2018c), and its flows ultimately reach the East Bay approximately 4.7 miles to the west. No formal jurisdictional delineation was conducted during the site visit, but the creek is likely under the jurisdiction of the USACE as Waters of the U.S. and under the jurisdiction of the CDFW and San

City of Hayward
22626 4th Street Residential Project

Francisco Bay RWQCB (SFRWQCB) as Waters of the State. Any work that could affect the creek would require a formal delineation of the bed and bank, followed by agency consultation and applications for permits to conduct work that would impact the creek. Required permits would fall under the CWA Sections 401 and 404, and the CFGC Section 1600 et seq.

The existing property fence is approximately 15 feet back from the top of the creek bank and project site plans call for another 20-foot setback from the edge of the property line to buildings. Therefore, no development is anticipated to occur within at least 15 feet of the top of the bank, and most construction activities would not occur within 35 or more feet of the top of the bank. The project would be required to develop a Stormwater Pollution Prevention Plan (SWPPP) (see Section 9, *Hydrology and Water Quality*) that would ensure that no discharge from the project site reaches the creek during construction. With implementation of the 20-foot setback, SWPPP, and mitigation measures BIO-1 through BIO-3 listed in the response to question (a), impacts to San Lorenzo Creek will be less than significant.

LESS THAN SIGNIFICANT WITH MITIGATION INCORPORATED

- d. *Would the project interfere substantially with the movement of any native resident or migratory fish or wildlife species or with established native resident or migratory wildlife corridors, or impede the use of native wildlife nursery sites?*

Wildlife movement corridors, or habitat linkages, are generally defined as connections between habitat patches that allow for physical and genetic exchange between otherwise isolated wildlife populations. The project site is located in an area where habitat has been fragmented by urban residential and commercial development uses. To facilitate movement and dispersal, wildlife movement corridors need to provide suitable habitat for species as they pass through or temporarily shelter within the corridor area. The habitat need not be similar to the habitat patches it is connecting, but should still provide those primary constituent elements (i.e., space for individual and population growth, breeding, foraging, and shelter) necessary for the species' survival.

The project lies within a heavily urban area consisting of residential and commercial developed with little access to open space. The project site is not expected to support wildlife movement because of the recent historical disturbance, lack of habitat and, urban surroundings. San Lorenzo Creek provides some small opportunity for wildlife movement and dispersal around the project site. Implementation of mitigation measures BIO-1 through BIO-4 listed in the response to question (a) would ensure that no habitat in the creek is disturbed. Therefore, impacts to wildlife movement corridors will be less than significant with implementation of mitigation measures.

LESS THAN SIGNIFICANT WITH MITIGATION INCORPORATED

- e. *Would the project conflict with any local policies or ordinances protecting biological resources, such as a tree preservation policy or ordinance?*

As discussed above under regulatory setting, HMC Chapter 10, Article 15, Tree Preservation, requires a permit for the removal, destruction, or cutting of branches over one inch in diameter, or disfigurement of any Protected Tree, among other requirements. An arborist report was prepared for the project in support of an application for a tree removal/pruning permit (HortScience, Inc. 2017, Appendix A). As shown in Table 5, of the 109 trees assessed in the report (including five off-site trees and nine street trees), 79 of the trees qualify as protected trees.

Table 5 Location and Number of Trees to be Removed

	On-site	Off-site Adjacent (with Canopy On-site)	Street	Total
Existing number of trees	96	5	9	109
Existing number of protected trees	66	5	9	79
Number of trees removed	81	0	3	84
Number of protected trees removed	52	0	3	55
Number of trees preserved	9	5	6	25
Number of protected trees preserved	8	5	6	24

Notes: Numbers reflect the preliminary development plan, existing conditions and demolition plan (RJA 2017a) and arborist report (HortScience, Inc. 2017)

As shown in the above table, the proposed project would involve the removal of 84 trees, of which 55 are considered protected. The total estimated value of the protected trees to be removed is \$243,350 (HortScience, Inc. 2017). To mitigate the loss of the 55 protected trees, the Preliminary Landscape Plan includes planting 44 replacement trees with a total value of an estimated \$93,550.00 (Ripley Design Group 2017). Under Article 15, the City Landscape Architect has the discretion to allow for alternative forms of mitigation, such as permeable paving, in addition to planting replacement trees. The project also includes proposed mitigation in the form of design improvements, including the use of permeable paving and larger replacement trees. Mitigation Measure BIO-2 is required to confirm that the proposed mitigation cost matches or exceeds the appraised value of the removed trees.

Further, in order to protect existing trees during and after construction to ensure long-term health and sustainability of preserved and replacement trees, mitigation measures BIO-3 and BIO-4 are required. With mitigation, impacts will be less than significant.

Mitigation Measures

The following mitigation is required to protect trees during construction to ensure long-term health and sustainability of preserved and replaced trees:

BIO-5 Tree Replacement As required by the HMC, the applicant shall replace removed protected trees with like-size, like-kind trees or an equal value tree, or implement alternative forms of mitigation as determined by the City's Landscape Architect. The City's Landscape Architect shall review the final landscape plan to confirm that the proposed mitigation cost matches or exceeds the appraised value of the removed trees prior to the issuance of building permit.

BIO-6 Tree Preservation Measures Tree Preservation measures are required to protect trees that will be preserved in place and replacement trees that will be planted as required under Mitigation Measure BIO-5.

Design Recommendations

1. Establish a tree protection zone around each tree to be preserved. No grading, excavation, construction, or storage of materials shall occur inside this ZONE.

No underground services including utilities, sub-drains, water, or sewer shall be placed in the tree protection zone. For design purposes, the tree protection zone shall be as follows:

- a. 2 feet behind the limit of soil remediation or grading for trees #8, 16–18, 20, 22–29, 32, and 48.
 - b. The existing property line for trees #8, 16, 17, and 56.
 - c. 2 feet behind the limit of grading or construction for trees #57 and 58.
 - d. 14 feet from the trunk of tree #68.
 - e. 1 foot behind the limit of excavation or grading for street trees #102, 104–107, and 109.
2. Any herbicides placed under paving materials must be safe for use around trees and labeled for that use.
 3. As trees withdraw water from the soil, expansive soils may shrink in the root area. Therefore, foundations, footings and pavements on expansive soils near trees should be designed to withstand differential displacement.
 4. Apply and maintain 4–6 inches of wood chip mulch within the TPZ or tree-well area. Keep mulch 2 inches from the base of the tree.
 5. Tree Preservation Guidelines prepared by the Project Arborist, which include specifications for tree protection during demolition and construction, should be included on all plans.

Pre-demolition and Pre-construction Treatments and Recommendations

1. The demolition and construction superintendents shall meet with the Project Arborist before beginning work to review all work procedures, access routes, storage areas, and tree protection measures.
2. The tree protection zone shall be fenced at prior to demolition, grubbing or grading. Fences shall be 6-foot chain link or equivalent as approved by the City.
3. Structures and underground features to be removed in the tree protection zone shall use equipment that will minimize damage to trees above and below ground, and operate from outside the tree protection zone. Tie back branches and wrap trunks with protective materials to protect from injury as directed by the Project Arborist. The Project Arborist shall be on-site during all operations within the tree protection zone to monitor demolition activity.
4. All tree work shall comply with the Migratory Bird Treaty Act as well as California Fish and Wildlife code 3503-3513 to not disturb nesting birds. To the extent feasible tree pruning and removal should be scheduled outside of the breeding season. Breeding bird surveys should be conducted prior to tree work. Qualified biologists should be involved in establishing work buffers for active nests.

Recommendations for Tree Protection during Construction

1. Any approved grading, construction, demolition or other work within the tree protection zone should be monitored by the Project Arborist.

2. All contractors shall conduct operations in a manner that will prevent damage to trees to be preserved.
3. Tree protection devices are to remain until all site work has been completed in the work area. Fences or other protection devices may not be relocated or removed without permission of the Project Arborist.
4. Construction trailers, traffic and storage areas must remain outside tree protection zone at all times.
5. No excess soil, chemicals, debris, equipment or other materials shall be dumped or stored within the tree protection zone.
6. Any root pruning required for construction purposes shall receive the prior approval of and be supervised by the Project Arborist. Roots should be cut with a saw to provide a flat and smooth cut. Removal of roots larger than 2 inches in diameter should be avoided.
7. If roots larger than 2 inches in diameter are encountered during site work and must be cut to complete the construction, the Project Arborist must be consulted to evaluate effects on the health and stability of the tree and recommend treatment.
8. All trees to be retained shall be irrigated on a schedule to be determined by the Project Arborist (every 3 to 6 weeks is typical). Each irrigation shall wet the soil within the tree protection zone to a depth of 18 to 30 inches.
9. If injury should occur to any tree during construction, it should be evaluated as soon as possible by the Project Arborist so that appropriate treatments can be applied.
10. Any additional tree pruning needed for clearance during construction must be performed by a Certified Arborist and not by construction personnel.
11. Prior to grading or trenching, trees may require root pruning outside the tree protection zone. Any root pruning required for construction purposes shall receive the prior approval of, and be supervised by, the Project Arborist.
12. No excess soil, chemicals, debris, equipment or other materials shall be dumped or stored within the tree protection zone.
13. Trees that accumulate a sufficient quantity of dust on their leaves, limbs and trunk as judged by the Project Arborist shall be spray-washed at the direction of the Project Arborist.

BIO-7 **Tree Replacement and Maintenance** Replacement trees shall be planted with sufficient space to accommodate the mature size of the species and maintained sufficiently to ensure establishment. Preserved trees shall also be maintained to ensure the continued long-term health of the tree. Trees on-site shall be monitored and routine maintenance, such as occasional pruning, fertilization, mulch, pest management, replanting, and irrigation, shall be conducted by a landscape specialist.

With implementation of the above measures, the project will not conflict with any local or regional ordinance.

LESS THAN SIGNIFICANT WITH MITIGATION INCORPORATED

City of Hayward
22626 4th Street Residential Project

- f. Would the project conflict with the provisions of an adopted Habitat Conservation Plan, Natural Community Conservation Plan, or other approved local, regional, or state habitat conservation plan?*

There are no habitat conservation plans, natural community conservation plans, or other similar plans that govern activities on the project site. Therefore, the project will not be in conflict with any habitat conservation plans.

NO IMPACT

5 Cultural Resources

	Potentially Significant Impact	Less than Significant with Mitigation Incorporated	Less than Significant Impact	No Impact
Would the project:				
a. Cause a substantial adverse change in the significance of a historical resource as defined in §15064.5?	<input type="checkbox"/>	<input checked="" type="checkbox"/>	<input type="checkbox"/>	<input type="checkbox"/>
b. Cause a substantial adverse change in the significance of an archaeological resource as defined in §15064.5?	<input type="checkbox"/>	<input checked="" type="checkbox"/>	<input type="checkbox"/>	<input type="checkbox"/>
c. Directly or indirectly destroy a unique paleontological resource or site or unique geological feature?	<input type="checkbox"/>	<input type="checkbox"/>	<input type="checkbox"/>	<input checked="" type="checkbox"/>
d. Disturb any human remains, including those interred outside of formal cemeteries?	<input type="checkbox"/>	<input type="checkbox"/>	<input checked="" type="checkbox"/>	<input type="checkbox"/>

Historical and Archaeological Resources

Rincon conducted a search of the California Historical Resources Information System (CHRIS) at the Northwest Information Center (NWIC) located at Sonoma State University on January 25, 2018. The search was performed to identify previously recorded cultural resources, as well as previously conducted cultural resources studies within the project site and a 0.5-mile radius surrounding it. The CHRIS search included a review of available records at the NWIC, as well as the National Register of Historic Places (NRHP), the California Register of Historical Resources (CRHR), the Office of Historic Preservation Historic Properties Directory, the California Inventory of Historic Resources, the Archaeological Determinations of Eligibility list, and historic maps.

The NWIC records search identified 47 cultural resources studies conducted within a 0.5-mile radius of the project site. Study 38751 included the project site and identified 1410 and 1422 B Street (P-01-011269 and P-01-011349, respectively) in the current project site. Neither property has been formally recorded, but both were previously determined not eligible for listing in the NRHP and have since been demolished.

The NWIC records search identified 132 previously recorded cultural resources within a 0.5-mile radius of the project site, of which only two (1410 B Street [P-01-011269] and 1422 B Street [P-01-011349]) are located in the project site. Of the resources within the search radius, two are prehistoric archaeological sites containing burials and one is a historic tree.

Resource CA-ALA-58 is located roughly 2,020 feet west of the current project site and consisted of an earthen mound with limited shell and artifacts and at least two burials. The site has been presumed recorded as destroyed and was not evaluated for listing in the NRHP or CRHR. No updates to the site record have been made since 1959.

City of Hayward
22626 4th Street Residential Project

Resource CA-ALA-566 is located roughly 1,300 feet north of the project site at a depth of 8 to 80 inches and included at least one burial and several features. CA-ALA-566 was not evaluated for NRHP or CRHR listing when it was recorded in 1997, but is presumed eligible for the purposes of the current project based on the presence of human remains.

Resource P-01-003338 consists of a historic tree known variously as the “Laurel,” “Bay,” or “Pow-Wow” tree. The tree was located directly adjacent to the current project site but was felled in 1975 by strong winds. The tree was identified as a gathering place for Native Americans and later as a gathering place by local Boy Scout and Girls Scout groups.

In addition, Rincon reviewed *Historical Resources Survey & Inventory Report* (Circa 2010), which among other items, summarized the results of a Reconnaissance-level survey of City-identified historic properties. This review indicated that the proposed project is located within the boundaries of the potential Upper B Street Historic District, which was first identified in the early 1990s as part of the Neighborhood Plan Study. The 2010 report confirmed the eligibility of the historic district and refined the boundaries to roughly include properties between A Street to the north and E Street to the south, and between 2nd Street to the west and 6th Street to the east. The district was recommended as locally eligible for its significance as one of the City’s first residential neighborhoods, and as a noteworthy example of residential development in pre-World War II Hayward. Of the approximately 230 properties within the district, approximately 125 were identified as contributors. These represent a concentration of late 19th and early 20th century residential properties in a variety of architectural styles representative of that period of development. Architectural styles that represented neighborhood include Queen Ann cottages, Folk Victorian residences, Neoclassical rowhouses and cottages, modest workers cottages, one and two-story Craftsman style dwellings, and California bungalows. According to the 2010 report, despite physical changes to the district overtime, the neighborhood retains a good degree of historic character, residential scale and visual coherence. Although the district has not been formally designated by the City, as a historic district that is eligible for a local register, it is considered a historical resource under CEQA.

On January 12, 2018, Rincon contacted the Native American Heritage Commission (NAHC) and requested a search of the Sacred Lands File (SLF). The NAHC emailed a response on January 18, 2018 stating that the SLF search was returned with negative results. The results also included a list of four Native American contacts who may have information regarding the project site. Rincon prepared and mailed informal scoping letters to each contact requesting any information they may have regarding the project. As of February 26, 2018, no responses have been received.

Rincon Archaeologist Sydni Kitchel conducted an intensive pedestrian field survey of the project site on February 13, 2018. Ms. Kitchel walked 5- to 10-meter (approximately 16- to 33-foot) transects and examined exposed ground surface for artifacts (e.g., flaked stone tools, tool-making debris, stone milling tools, ceramics, fire-affected rock [FAR]), ecofacts (marine shell and bone), soil discoloration that might indicate the presence of a cultural midden, soil depressions, and features indicative of the former presence of structures or buildings (e.g., standing exterior walls, postholes, foundations) or historic debris (e.g., metal, glass, ceramics). Additionally, ground disturbances such as animal burrows and drainages were visually inspected.

Ground visibility at the project site was poor in many areas due to thick vegetation. Foundations and limited amounts of building refuse and glass from each demolished property discussed above were identified in the project site but were not recorded because the properties have been previously determined ineligible for NRHP listing. Modern refuse was scattered throughout the project site.

Paleontological Resources

Rincon evaluated the paleontological sensitivity of the geologic units that underlie the project area using the results of the paleontological locality search and literature review. Rincon reviewed fossil collections records from the University of California Museum of Paleontology (UCMP) online database, which contains known fossil localities in Alameda County, and reviewed geologic maps and scientific literature including Barron 1989, Bartow et al. 1990, California Geological Survey [CGS] 2002, Fossen 2010, Graymer 2000, Graymer et al. 1996, Helley and Graymer 1997, Norris and Webb 1990, and Schemmann et al. 2008).

Rincon assigned a paleontological sensitivity to the geologic units within the project area. The potential for impacts to significant paleontological resources is based on the potential for ground disturbance to directly impact paleontologically sensitive geologic units as defined by the Society for Vertebrate Paleontology (SVP 2010).

The project area is mapped at a scale of 1:50,000 by Graymer (2000) and includes two (2) geologic units mapped at ground surface: Holocene levee (Qhl) and alluvial fan and fluvial deposits (Qhaf). The younger Quaternary deposits are composed of alluvial fan facies comprised of unconsolidated brown to tan gravely sand and silt, fluvial facies of brown sand and silty clay, and natural levee sand and mud deposits (Helley and Graymer 1997). These Holocene deposits are underlain by rocks of the Cretaceous Central Valley Sequence and older Pleistocene alluvium at moderate depth (approximately 10 to 20 feet below ground surface [bgs]). Holocene deposits are generally considered too young to contain fossilized remains.

A search of the paleontological locality records on the UCMP online database resulted in no previously recorded vertebrate fossil localities within Holocene sedimentary deposits in the project vicinity.

Consistent with SVP (2010) guidelines, Rincon determined the paleontological sensitivity of the project area based on a literature review and museum locality search. Holocene sedimentary deposits, particularly those younger than 5,000 years old, are generally too young to contain fossilized material. Therefore, the Holocene alluvial, fluvial, and levee sediments mapped at the surface of the project area have been assigned a low paleontological sensitivity.

Impact Analysis

- a. *Would the project cause a substantial adverse change in the significance of a historical resource as defined in §15064.5?*
- b. *Would the project cause a substantial adverse change in the significance of an archaeological resource as defined in §15064.5?*

The project site previously was developed with residential buildings that were identified as ineligible for listing as historic resources by the City and demolished in 2017. The project site does not contain historic resources that would directly be affected by development of the project. As discussed above, the project site is in the boundaries of the Upper B Street Historic District which has been identified as a locally eligible historic district in the *City of Hayward Historical Resources Survey & Inventory Report* (2010) and therefore is considered a historical resource under CEQA. A substantial adverse change in the significance of a historical resource occurs when the resource is materially impaired, or those characteristics that define the resource are altered such that it is no longer able to convey the reasons for its significance. As discussed above in the “Historical and Archaeological Resources” setting discussion, the Upper B Street Historic District is locally significant as one of the

City of Hayward
22626 4th Street Residential Project

City's first residential neighborhoods, and as a noteworthy example of residential development in pre-World War II Hayward. Those features that convey this significance are represented in the residential character of the neighborhood and the variety of Queen Ann cottages, Folk Victorian residences, Neoclassical rowhouses and cottages it contains. The proposed project would subdivide a currently vacant lot with 41 detached single-family residences, common open space, and private streets that would have vehicular access from a public street, B Street. No contributing properties or features of the historic district would be directly affected as a result of the property, either through demolition or alteration. Because the project site historically contained residential properties, and the introduction of new single-family residences would be consistent with the existing use and historic character of the site and the surrounding potential historic district. Further, the proposed size and scale of the new residences is compatible with those properties that define the historic district and would therefore not result in any potential indirect impacts to the historic district. Because the proposed project would not result in the demolition, destruction, relocation, or alteration of the potential historic district such that it would no longer be able to convey the reasons for its historical significance, the project would result in less than significant impacts to historical resources.

The results of the cultural resources records search, Native American outreach, and intensive pedestrian field survey concluded that no known cultural resources exist on the project site. However, two prehistoric archaeological resources were identified in the records search radius, one tree thought to have been a Native American gathering place is recorded directly adjacent to the project site, and the San Lorenzo Creek is known to have been an important natural resource for Native Americans living in the region. Based on these factors, the project site and vicinity are considered sensitive for archaeological resources. The following mitigation measures are required.

- CUL-1 Worker's Environmental Awareness Program (WEAP).** A qualified archaeologist shall be retained who meets the Secretary of the Interior's Professional Qualifications Standards for archaeology to conduct a WEAP training for archaeological sensitivity for all construction personnel prior to the commencement of any ground disturbing activities. Archaeological sensitivity training should include a description of the types of cultural material that may be encountered, cultural sensitivity issues, regulatory issues, and the proper protocol for treatment of the materials in the event of a find.
- CUL-2 Archaeological and Native American Monitoring.** Initial project-related ground-disturbing activities shall be observed by a qualified archaeological monitor under the direction of an archaeologist meeting the Secretary of the Interior's Professional Qualifications Standards for prehistoric archaeology (NPS 1983). Initial ground disturbance is defined as activities within previously undisturbed native soils. Monitoring activities shall be coordinated with the Federated Indians of Graton Rancheria and a Native American monitor shall be retained for the duration of project ground disturbance. If archaeological resources are encountered during ground-disturbing activities, work in the immediate area must halt and the find evaluated for significance under CEQA. Monitoring may be reduced or halted at the discretion of the monitors as warranted by conditions such as encountering bedrock, sediments being excavated are fill, soils occur within formations unlikely to yield cultural resources (e.g., soils formations predating human occupation of the region), or negative findings during the first 60 percent of rough grading. If monitoring is reduced to spot-checking, spot-checking shall occur when ground-disturbance moves to a new location in the project site and when

ground disturbance will extend to depths not previously reached (unless those depths are within bedrock).

- CUL-3 Unanticipated Discovery of Cultural Resources.** If cultural resources are encountered during ground disturbing activities, work in the immediate area should be halted and an archaeologist meeting the Secretary of the Interior's Professional Qualification Standards for archaeology (NPS 1983) should be contacted immediately to evaluate the find. If necessary, the evaluation may require preparation of a treatment plan and testing for the California Register of Historical Resources (CRHR) eligibility. If the discovery proves to be significant under CEQA and cannot be avoided by the project, additional work, such as data recovery excavation, may be required to mitigate any significant impacts to historical resources.

LESS THAN SIGNIFICANT WITH MITIGATION INCORPORATED

- c. *Would the project directly or indirectly destroy a unique paleontological resource or site or unique geological feature?*

The Holocene alluvial deposits mapped at ground surface in the project area are determined to have a low paleontological resource potential and they are likely too young to contain fossilized material. The project site does not contain a unique geological feature. Therefore, the proposed project would not unearth paleontological resources during construction. No impacts to paleontological resources or unique geological features will occur.

NO IMPACT

- d. *Disturb any human remains, including those interred outside of formal cemeteries?*

The discovery of human remains is always a possibility during ground disturbing activities. If human remains are found, the State of California Health and Safety Code Section 7050.5 states that no further disturbance shall occur until the County Coroner has made a determination of origin and disposition pursuant to Public Resources Code Section 5097.98. In the event of an unanticipated discovery of human remains, the County Coroner must be notified immediately. If the human remains are determined to be prehistoric, the Coroner would notify the Native American Heritage Commission which will determine and notify a most likely descendant (MLD). The MLD must complete the inspection of the site and provide recommendations for treatment to the landowner within 48 hours of being granted access. With adherence to existing regulations, impacts to human remains will be less than significant.

LESS THAN SIGNIFICANT IMPACT

This page intentionally left blank.

6 Geology and Soils

	Potentially Significant Impact	Less than Significant with Mitigation Incorporated	Less than Significant Impact	No Impact
Would the project:				
a. Expose people or structures to potentially substantial adverse effects, including the risk of loss, injury, or death involving:				
1. Rupture of a known earthquake fault, as delineated on the most recent Alquist-Priolo Earthquake Fault Zoning Map issued by the State Geologist for the area or based on other substantial evidence of a known fault?	<input type="checkbox"/>	<input type="checkbox"/>	<input type="checkbox"/>	<input checked="" type="checkbox"/>
2. Strong seismic ground shaking?	<input type="checkbox"/>	<input checked="" type="checkbox"/>	<input type="checkbox"/>	<input type="checkbox"/>
3. Seismic-related ground failure, including liquefaction?	<input type="checkbox"/>	<input checked="" type="checkbox"/>	<input type="checkbox"/>	<input type="checkbox"/>
4. Landslides?	<input type="checkbox"/>	<input type="checkbox"/>	<input type="checkbox"/>	<input checked="" type="checkbox"/>
b. Result in substantial soil erosion or the loss of topsoil?	<input type="checkbox"/>	<input type="checkbox"/>	<input checked="" type="checkbox"/>	<input type="checkbox"/>
c. Be located on a geologic unit or soil that is made unstable as a result of the project, and potentially result in on or offsite landslide, lateral spreading, subsidence, liquefaction, or collapse?	<input type="checkbox"/>	<input checked="" type="checkbox"/>	<input type="checkbox"/>	<input type="checkbox"/>
d. Be located on expansive soil, as defined in Table 1-B of the Uniform Building Code (1994), creating substantial risks to life or property?	<input type="checkbox"/>	<input checked="" type="checkbox"/>	<input type="checkbox"/>	<input type="checkbox"/>
e. Have soils incapable of adequately supporting the use of septic tanks or alternative wastewater disposal systems where sewers are not available for the disposal of wastewater?	<input type="checkbox"/>	<input type="checkbox"/>	<input type="checkbox"/>	<input checked="" type="checkbox"/>

City of Hayward
22626 4th Street Residential Project

- a.1. Would the project expose people or structures to potential substantial adverse effects, including the risk of loss, injury, or death involving rupture of a known earthquake fault, as delineated on the most recent Alquist-Priolo Earthquake Fault Zoning Map issued by the State Geologist for the area or based on other substantial evidence of a known fault?*

According to the Preliminary Geotechnical Assessment prepared by ENGEO in January 2017 (Appendix B), the project site is not located in an Alquist-Priolo Earthquake Fault Zone and there are no known faults crossing or projecting toward the site. Table 6 shows the distances from the project site to the nearest faults. The nearest fault is the Hayward Fault, approximately 0.5 mile southwest of the project site. Therefore, ground rupture due to faulting is unlikely at the project site. No impact will occur.

Table 6 Approximate Fault Distances from the Project Site

Fault Name	Distance (miles)
Hayward Fault	0.5
Calaveras Fault	7.8
San Andreas Fault	19.1

Source: ENGEO 2017 (Appendix B)

NO IMPACT

- a.2. Would the project expose people or structures to potential substantial adverse effects, including the risk of loss, injury, or death involving strong seismic ground shaking?*
- a.3. Would the project expose people or structures to potential substantial adverse effects, including the risk of loss, injury, or death involving seismic-related ground failure, including liquefaction?*
- c. Would the project be located on a geologic unit or soil that is made unstable as a result of the project, and potentially result in on or offsite landslide, lateral spreading, subsidence, liquefaction, or collapse?*

The San Francisco Bay Area region is one of the most seismically active areas in the country. While seismologists cannot predict earthquake events, the USGS's Working Group on California Earthquake Probabilities (WGCEP) estimates the likelihood that California will experience a magnitude 8 or larger earthquake in the next 30 years is about 7.0 percent (WGCEP 2015). The WGCEP also estimates that each region of California will experience a magnitude 6.7 or larger earthquake in the next 30 years. Additionally, there is a 63 percent chance of at least one magnitude 6.7 or greater earthquake occurring in the Bay Area region between 2007 and 2036.

The site is located in an area of relatively high seismic potential. The faults in the area are capable of generating large earthquakes that could produce strong to violent ground shaking at the project site. The active fault nearest the site is the Hayward fault, which is located approximately 0.5 mile to the southwest (ENGEO 2017) (Table 6).

The project site is also in a state-designated Liquefaction Hazard Zone (CGS 2012). Soil liquefaction results from loss of strength during cyclic loading, such as imposed by earthquakes. Soils most susceptible to liquefaction are clean, loose, saturated, and uniformly graded, fine-grained sands. As part of the geotechnical assessment, ENGEO performed a detailed liquefaction potential analysis.

The results indicated that there are layers of soil beneath the site that are potentially susceptible to liquefaction (ENGEO 2017).

Lateral spreading and earthquake-induced landsliding involve lateral ground movements caused by seismic shaking. These lateral ground movements are often associated with a weakening or failure of an embankment or soil mass overlying a layer of liquefied sands or weak soils. Due to San Lorenzo Creek bank creating a free-face and potentially liquefiable material, there is a potential for lateral spreading at the project site (ENGEO 2017).

Further, nine of the proposed residences (lots 3 through 12) would be located adjacent to San Lorenzo Creek. Development within the 3:1 (horizontal: vertical) line of projection from the toe of the creek bank (the notch where the vertical slope up from the creek meets the horizontal bottom of the creek) to the top of the creek bank could be susceptible to soil instability resulting from erosion of the creek banks. Of the lots adjacent to the creek, seven lots (lots 3 through 10) would have part of the building footprint within this 3:1 zone. For these seven residences, ENGEO provided separate slope stability recommendations in a letter dated June 30, 2017. This letter is included in Appendix B. Provided these slope stabilization measures are implemented for any building within the 3:1 zone, the residences would not be susceptible to soil instability resulting from creek bank erosion.

Therefore, impacts related to ground shaking, liquefaction, lateral-spreading, and slope stability are potentially significant without mitigation. Nonetheless, the ENGEO reports concluded that from a geotechnical viewpoint, the project is feasible provided the considerations included in Mitigation Measure GEO-1 below are addressed in the project design.

Mitigation Measures

The following mitigation measure shall be implemented prior to and during project construction:

GEO-1 Geotechnical Considerations. The project applicant shall implement all measures and recommendations set forth in ENGEO's January 2017 Preliminary Geotechnical Assessment and June 2017 Supplemental Conceptual Slope Stabilization Recommendations (Appendix B to the Initial Study). These recommendations include but are not limited to:

- Grading (demolition and stripping, existing fill and disturbed soil, selection of materials, differential fill thickness, fill placement, surface venting mitigation)
- Slope setback
- Slope stabilization for lots 3 through 10
- Building code seismic design
- Foundation design
- Pavement design
- Drainage
- Stormwater bioretention areas

In addition, a comprehensive site-specific, design-level geotechnical exploration shall be prepared for review and approval by the City of Hayward as part of the design process. The exploration may include borings and laboratory soil testing to provide data for preparation of specific recommendations regarding grading, foundation design,

City of Hayward
22626 4th Street Residential Project

corrosion potential, and drainage for the proposed project. The recommendations set forth in the design-level geotechnical exploration shall be implemented.

Pursuant to the 2017 Preliminary Geotechnical Assessment and Supplemental Conceptual Slope Stabilization Recommendations prepared for the project (Appendix B), provided the recommendations presented in the reports are complied with and implemented during design and construction, construction of the project would not create hazards related to site geology or soils and the effects of liquefaction-induced settlement on the proposed structure would be mitigated. Therefore, with implementation of Mitigation Measure GEO-1, the potentially significant impact associated with ground shaking, liquefaction, and slopes near the creek bank will be reduced to a less than significant level.

LESS THAN SIGNIFICANT WITH MITIGATION INCORPORATED

a.4. Would the project expose people or structures to potential substantial adverse effects, including the risk of loss, injury, or death involving landslides?

The project site and surroundings are generally level, and no steep slopes are located near the project. Therefore, there is no potential for landslides at the site. No impact will occur.

NO IMPACT

b. Would the project result in substantial soil erosion or the loss of topsoil?

Construction of the project would require earthwork activities during site preparation for the construction of the 41 single-family residences. As the project would disturb over one acre of land, the applicant would be required to obtain coverage under the General Permit for Discharges of Storm Water Associated with Construction Activity (Construction General Permit Order 2009-0009-DWQ or 2009-0009-DWQ General Permit) to comply with CWA National Pollutant Discharge Elimination System (NPDES) requirements. Compliance with these requirements would include preparation of a SWPPP, which would specify Best Management Practices (BMP) to quickly contain and clean up any accidental spills or leaks. In accordance with Hayward Municipal Code (HMC) Section 10-3.705, the project applicant is also required to prepare and implement an Erosion and Sediment Control Plan to prevent illicit discharge. Appropriate erosion control and permanent site surface drainage elements per the latest California Building Code would also be implemented. With required implementation of these plans, permits, and BMPs, substantial erosion or the loss of top soil would not occur at the project site. Impacts will be less than significant.

LESS THAN SIGNIFICANT IMPACT

d. Would the project be located on expansive soil, as defined in Table 1-B of the Uniform Building Code (1994), creating substantial risks to life or property?

The Preliminary Geotechnical Assessment found the project site to have expansive clay near the surface of the site. Expansive soils change in volume with changes in moisture. These soils can shrink or swell and cause heaving and cracking of slabs-on-grade, pavements, and structures founded on shallow foundations, resulting in a potentially significant impact. However, implementation of Mitigation Measure GEO-1 would reduce the swell potential of the clay by compacting the soil at a high moisture content, controlling the amount of soil compaction. Impacts from expansive soil will be less than significant with implementation of mitigation.

LESS THAN SIGNIFICANT WITH MITIGATION INCORPORATED

- e. *Would the project have soils incapable of adequately supporting the use of septic tanks or alternative wastewater disposal systems where sewers are not available for the disposal of wastewater?*

The project would not include components that would require the use of septic tanks. The project site and facilities are already connected to the City of Hayward municipal sewer system, as would be the project. There will be no impact.

NO IMPACT

This page intentionally left blank.

7 Greenhouse Gas Emissions

	Potentially Significant Impact	Less than Significant with Mitigation Incorporated	Less than Significant Impact	No Impact
Would the project:				
a. Generate greenhouse gas emissions, either directly or indirectly, that may have a significant impact on the environment?	<input type="checkbox"/>	<input type="checkbox"/>	<input checked="" type="checkbox"/>	<input type="checkbox"/>
b. Conflict with any applicable plan, policy, or regulation adopted for the purposes of reducing the emissions of greenhouse gases?	<input type="checkbox"/>	<input type="checkbox"/>	<input checked="" type="checkbox"/>	<input type="checkbox"/>

Climate Change and Greenhouse Gas Emissions

Climate change is the observed increase in the average temperature of the earth's atmosphere and oceans along with other substantial changes in climate (such as wind patterns, precipitation, and storms) over an extended period of time. Climate change is the result of numerous, cumulative sources of greenhouse gases (GHG), gases that trap heat in the atmosphere, analogous to the way in which a greenhouse retains heat. Common GHGs include water vapor, carbon dioxide (CO₂), methane (CH₄), nitrous oxides (N₂O), fluorinated gases, and ozone. GHGs are emitted by both natural processes and human activities. Of these gases, CO₂ and CH₄ are emitted in the greatest quantities from human activities. Emissions of CO₂ are largely by-products of fossil fuel combustion, whereas CH₄ results from off-gassing associated with agricultural practices and landfills. Man-made GHGs, many of which have greater heat-absorption potential than CO₂, include fluorinated gases, such as hydrofluorocarbons (HFC), perfluorocarbons (PFC), and sulfur hexafluoride (SF₆) (Cal EPA 2015).

The accumulation of GHGs in the atmosphere regulates the earth's temperature. Without the natural heat-trapping effect of GHGs, Earth's surface would be about 34° C cooler (Cal EPA 2015). However, it is believed that emissions from human activities, particularly the consumption of fossil fuels for electricity production and transportation, have elevated the concentration of these gases in the atmosphere beyond the level of naturally occurring concentrations.

Thresholds

Pursuant to the requirements of SB 97, the Resources Agency adopted amendments to the CEQA Guidelines for the feasible mitigation of GHG emissions and analysis of the effects of GHG emissions. The adopted CEQA Guidelines provide regulatory guidance on the analysis and mitigation of GHG emissions in CEQA documents, while giving lead agencies the discretion to set quantitative or qualitative thresholds for the assessment and mitigation of GHGs and climate change impacts.

The vast majority of individual projects do not generate sufficient GHG emissions to directly influence climate change. However, physical changes caused by a project can contribute

incrementally to cumulative effects that are significant, even if individual changes resulting from a project are limited. The issue of climate change typically involves an analysis of whether a project's contribution towards an impact would be cumulatively considerable. "Cumulatively considerable" means that the incremental effects of an individual project are significant when viewed in connection with the effects of past projects, other current projects, and probable future projects (CEQA Guidelines, Section 15064[h][1]).

According to the *CEQA Guidelines*, projects can tier off of a qualified GHG reduction plan, which allows for project-level evaluation of GHG emissions through the comparison of the project's consistency with the GHG reduction policies included in a qualified GHG reduction plan. This approach is considered by the Association of Environmental Professionals (AEP) in their white paper, *Beyond Newhall and 2020*, to be the most defensible approach presently available under CEQA to determine the significance of a project's GHG emissions (2016). Hayward does not currently have a qualified GHG reduction plan and thus this approach is not currently feasible.

To evaluate whether a project may generate a quantity of GHG emissions that may have a significant impact on the environment, a number of operational bright-line significance thresholds have been developed by state agencies. Significance thresholds are numeric mass emissions thresholds that identify the level at which additional analysis of project GHG emissions is necessary. Projects that attain the significance target, with or without mitigation, would result in less than significant GHG emissions. Many significance thresholds have been developed to reflect a 90 percent capture rate tied to the 2020 reduction target established in Assembly Bill (AB) 32. These targets have been identified by numerous lead agencies (including the City of Hayward) as appropriate significance screening tools for residential, commercial, industrial, and public land uses and facilities projects with horizon years before 2020.

In the 2017 BAAQMD *CEQA Air Quality Guidelines*, the BAAQMD outlines an approach to determine the significance of projects. For residential, commercial, industrial, and public land use development projects, the thresholds of significance for operational-related GHG emissions are as follows:

- Compliance with a qualified GHG Reduction Strategy
- Annual emissions less than 1,100 metric tons per year (MT/yr) of equivalent carbon dioxide (CO₂e)
- Service person threshold of 4.6 MT CO₂e/SP/yr (residents + employees)

The annual emissions threshold of 1,100 MT of CO₂e per year applies best to the proposed project Hayward does not have a qualified GHG reduction plan and the project is not a high-density project whose impacts would be more appropriately quantified by a service population threshold to reflect the per-person emission efficiency. The BAAQMD annual emissions threshold was designed to capture 90 percent of all emissions associated with projects in the Basin and require implementation of mitigation so that a considerable reduction in emissions from new projects would be achieved. According to the California Air Pollution Control Officers Association (CAPCOA) white paper, *CEQA & Climate Change* (2008), a quantitative threshold based on a 90 percent market capture rate is generally consistent with AB 32 (CAPCOA 2008). Additionally, the AEP white paper, *Beyond Newhall and 2020*, recommends that for projects with a horizon of 2020 or earlier, a threshold based on meeting AB 32 targets should be used (AEP 2016). Thus, projects with horizon years of 2020 or earlier, and emissions below the BAAQMD threshold are not expected to require GHG mitigation for state mandates to be achieved. The project would be fully operational in 2020. Therefore, its horizon year is 2020.

Methodology

As discussed under Section 3, *Air Quality*, the BAAQMD developed screening criteria to provide lead agencies and project applicants with a conservative indication of whether a project could result in potentially significant GHG impacts. If all of the screening criteria are met by a project, then the lead agency or applicant would not need to perform a detailed GHG assessment of their project's GHG emissions (BAAQMD 2017c). For single-family residences, the operational GHG screening size is 56 dwelling units. The proposed project involves 41 dwelling units and is below the screening level. Therefore, a detailed GHG assessment was not required for the project.

Impact Analysis

- a. *Would the project generate GHG emissions, either directly or indirectly, that may have a significant impact on the environment?*

The project's proposed construction activities, energy use, daily operational activities, and mobile sources (traffic) would generate GHG emissions. As mentioned under *Methodology*, according to BAAQMD, as the project's proposed 41 residential units are well below the 56-unit screening criteria, a detailed air quality assessment of the proposed project's GHG emissions is not required as operational GHG emissions would not exceed BAAQMD thresholds. In addition, the project will be required to comply with all BAAQMD rules and regulations regarding emission control measures. Further, each residence would include rooftop solar PV panels. The use of renewable solar energy would reduce GHG emissions from energy use. Therefore, impacts related to GHG emissions will be less than significant.

LESS THAN SIGNIFICANT IMPACT

- b. *Would the project conflict with any applicable plan, policy, or regulation adopted for the purpose of reducing the emissions of greenhouse gases?*

As discussed above, the project would not result in GHG emissions above thresholds that were established by BAAQMD to identify projects that require additional mitigation measures to achieve statewide GHG targets contained in AB 32.

The project is in an urban area near transit and schools and would be constructed in accordance with CALGreen (Part 11 of Title 24 of the California Code of Regulations) requirements for Residential Development.

Hayward's Climate Action Plan (CAP) was adopted by the Hayward City Council on July 28, 2009. The purpose of the CAP is to make Hayward a more environmentally and socially sustainable community. The overall objective of the CAP is to reduce Hayward's greenhouse gas emissions by the following amounts:

- 20 percent below 2005 baseline levels by 2020
- 62.7 percent below 2005 baseline levels by 2040
- 82.5 percent below 2005 baseline levels by 2050

The proposed project involves infill development in an urban area. The houses would include solar panels to reduce energy use and associated GHG emissions. The project would not conflict with the Climate Change Scoping Plan developed per AB 32, the land use assumptions in the Plan Bay Area,

City of Hayward
22626 4th Street Residential Project

or regulations adopted by the City of Hayward to reduce greenhouse gas emissions. Therefore, the project will have a less than significant impact.

LESS THAN SIGNIFICANT IMPACT

8 Hazards and Hazardous Materials

	Potentially Significant Impact	Less than Significant with Mitigation Incorporated	Less than Significant Impact	No Impact
--	--------------------------------	--	------------------------------	-----------

Would the project:

a. Create a significant hazard to the public or the environment through the routine transport, use, or disposal of hazardous materials?	<input type="checkbox"/>	<input type="checkbox"/>	<input checked="" type="checkbox"/>	<input type="checkbox"/>
b. Create a significant hazard to the public or the environment through reasonably foreseeable upset and accident conditions involving the release of hazardous materials into the environment?	<input type="checkbox"/>	<input type="checkbox"/>	<input checked="" type="checkbox"/>	<input type="checkbox"/>
c. Emit hazardous emissions or handle hazardous or acutely hazardous materials, substances, or waste within 0.25 mile of an existing or proposed school?	<input type="checkbox"/>	<input type="checkbox"/>	<input checked="" type="checkbox"/>	<input type="checkbox"/>
d. Be located on a site that is included on a list of hazardous material sites compiled pursuant to Government Code Section 65962.5 and, as a result, would it create a significant hazard to the public or the environment?	<input type="checkbox"/>	<input checked="" type="checkbox"/>	<input type="checkbox"/>	<input type="checkbox"/>
e. For a project located in an airport land use plan or, where such a plan has not been adopted, within two miles of a public airport or public use airport, would the project result in a safety hazard for people residing or working in the project area?	<input type="checkbox"/>	<input type="checkbox"/>	<input type="checkbox"/>	<input checked="" type="checkbox"/>
f. For a project within the vicinity of a private airstrip, would the project result in a safety hazard for people residing or working in the project area?	<input type="checkbox"/>	<input type="checkbox"/>	<input type="checkbox"/>	<input checked="" type="checkbox"/>

	Potentially Significant Impact	Less than Significant with Mitigation Incorporated	Less than Significant Impact	No Impact
g. Impair implementation of or physically interfere with an adopted emergency response plan or emergency evacuation plan?	<input type="checkbox"/>	<input type="checkbox"/>	<input type="checkbox"/>	<input checked="" type="checkbox"/>
h. Expose people or structures to a significant risk of loss, injury, or death involving wildland fires, including where wildlands are adjacent to urbanized areas or where residences are intermixed with wildlands?	<input type="checkbox"/>	<input type="checkbox"/>	<input type="checkbox"/>	<input checked="" type="checkbox"/>

- a. *Would the project create a significant hazard to the public or the environment through the routine transport, use, or disposal of hazardous materials?*
- b. *Would the project create a significant hazard to the public or the environment through reasonably foreseeable upset and accident conditions involving the release of hazardous materials into the environment?*

Construction Activities

The project would involve the the construction of 41 single-family residences, private roadways, parking areas, and landscaping. Construction activities may include the temporary transport, storage, use, or disposal of potentially hazardous materials including fuels, lubricating fluids, cleaners, solvents, or contaminated soils. If spilled, these substances could pose a risk to the environment and to human health. However, the transport, storage, use, or disposal of hazardous materials would be subject to federal, state, and local regulations pertaining to the transport, use, storage, and disposal of hazardous materials, which would assure that risks associated with hazardous materials are minimized. The transport of hazardous materials would be subject to federal, state, and local regulations, which would assure that risks associated with the transport of hazardous materials are minimized. In addition, construction activities that transport hazardous materials would be required to transport such materials along designated roadways in the city, thereby limiting risk of upset.

As the project would disturb over one acre of land, the applicant would be required to obtain coverage under the General Permit for Discharges of Storm Water Associated with Construction Activity (Construction General Permit Order 2009-0009-DWQ) to comply with CWA NPDES requirements. Compliance with these requirements includes preparation of a SWPPP, which would specify BMPs to quickly contain and clean up any accidental spills or leaks. Therefore, the potential for an accidental release of hazardous materials to harm the public or the environment would be low. Impacts related to hazardous materials during construction will be less than significant.

Operational Uses

The project would involve construction of 41 new single-family residences. Residential uses typically do not use or store large quantities of hazardous materials other than those typically used for household cleaning, maintenance, and landscaping. Therefore, the proposed project would not involve the use, storage, transportation, or disposal of hazardous materials. Impacts will be less than significant.

LESS THAN SIGNIFICANT IMPACT

- c. *Would the project emit hazardous emissions or handle hazardous or acutely hazardous materials, substances, or waste within 0.25 mile of an existing or proposed school?*

The project site is located approximately 435 feet (approximately 0.08 mile) northwest of KEY Academy Charter School and Charquin Elementary School, which share a campus. Although within 0.25-mile of an existing school, as described under parts (a) and (b), the project's construction and operation are subject to applicable federal, state, and local regulations to minimize the release of hazardous materials into the environment. Therefore, through adherence to applicable regulations, impacts will be less than significant.

LESS THAN SIGNIFICANT IMPACT

- d. *Would the project be located on a site included on a list of hazardous material sites compiled pursuant to Government Code Section 65962.5 and, as a result, would it create a significant hazard to the public or the environment?*

Government Code Section 65962.5 requires various state agencies to compile lists of hazardous waste disposal facilities, unauthorized release from underground storage tanks, contaminated drinking water wells, and solid waste facilities from which there is known migration of hazardous waste and submit such information to the Secretary for Environmental Protection on at least an annual basis. Cornerstone Earth Group prepared a Phase I Environmental Site Assessment (ESA) and Preliminary Soil Quality Evaluation for the project site in December 2016. As part of the report, Cornerstone conducted a review of federal, state, and local regulatory databases to evaluate the likelihood of contamination incidents at and near the site. The project site is not listed on any such regulatory databases (Cornerstone 2016).

Two adjacent properties were identified in the databases reported: AT&T Corporation (1391 B Street, corner of 4th and B Street across from project site) and Hutch's Car Wash (1367 A Street, approximately 200 feet west of the project site). These properties are discussed further below:

- **AT&T Corporation** (1391 B Street) was identified on several databases for the presence of former leaking underground storage tanks (UST) including a 500-gallon diesel tank, removed in 1948 and replaced with a 550-gallon diesel tank, removed in 1992 and replaced with a 2,000-gallon diesel tank. Soil was reportedly excavated from the tank location and three monitoring wells were installed in 1995 and 1996. Depth to groundwater was reported at 8.95 feet to 13.85 feet and groundwater flow direction was reported towards the southeast to northwest, which is cross-gradient from the project site. Benzene, toluene, ethylbenzene, and xylenes in groundwater samples were not detected above laboratory reporting limits during the quarterly sampling events. Though total petroleum hydrocarbons as diesel (TPHd) was initially detected at concentrations of 7,700 micrograms per liter ($\mu\text{g/L}$) and 3,700 $\mu\text{g/L}$ in 1992, it was detected at 140 $\mu\text{g/L}$ in 1996 at one well and was not detected in the other groundwater samples from the other two wells. The monitoring wells were reportedly destroyed in 1997. The case was closed

City of Hayward
22626 4th Street Residential Project

by the City of Hayward Fire Department in August 2009. Significant impacts from this property do not appear likely based on the reported groundwater flow direction (cross-gradient) and the case closure status.

- **Hutch's Car Wash/Hutch's Quick Lube/Hutch's Express Lube/Hayward Quick Lube/Gulf Service Station/The Car Valet** (1367 A Street) was identified on several databases for the presence of three former USTs. A gasoline service station was reportedly present in 1968. In 1086, three USTs were converted water storage tanks for a carwash operation and two double-walled 10,000 gallon gasoline USTs were installed. A 2,000 gallon waste oil UST was reportedly installed in 1992. In 2003, fuel sales stopped and the fuel dispensers were removed. The property is currently being monitored under the oversight of the City of Hayward Fire Department. According to the most recently available report (July 2016), four monitoring wells are monitored on a semi-annual basis for groundwater elevation, gradient, and quality. Groundwater flow is reportedly to the northwest. Total petroleum hydrocarbons as gasoline (TPHg) was detected at concentrations up to 30,000 µg/L. The two wells closest to the site are no longer sampled but according to historical analytical data, groundwater samples from these wells were consistently below the laboratory reporting limit for TPHg, benzene, toluene, ethylbenzene, total xylenes, methyl tert-butyl ether (MTBE), and fuel oxygenates. This property is downgradient from the project site and impacted groundwater appears to be on the western side of the property. As such, significant impacts from this property do not appear likely.

Based on Cornerstone's interpretation of the types of incidents involved at these sites, the locations of the reported incidents, and the assumed groundwater flow direction, hazardous materials associated with these sites are not likely to have significantly affected soil, soil vapor, or groundwater beneath the project site (Cornerstone 2016). Therefore, development of the project would not create a significant hazard to the public or the environment resulting from previous on- or off-site contamination from sites compiled to Government Code Section 65962.5.

As part of the Phase I ESA, Cornerstone reviewed historical use information of the project site and its surrounding area and collected soil samples to identify the likelihood of past uses of the site had created contamination not previously known or listed on one of the hazardous materials databases. Based on the information obtained during preparation of the study, the site appears to have been developed with rural residences since at least the late 1800s. Possible remnants of an orchard were observed on the site. Soil sampling was performed by GeoSolve in May 2016, GeoCon in September 2016, and Cornerstone in October and November 2016. Results from these soil samples detected lead concentrations above residential screening levels, arsenic above its published background concentration, and OCP compounds chlordane and dieldrin above their residential screening levels. These elevated concentrations were detected in several samples within the upper approximately 0.5 foot of soil. Additionally, the detected concentrations of soluble (STLC) lead and chlordane exceeded their respective non-RCRA hazardous waste limits. Based on these site conditions, construction activities could expose construction workers or nearby residents to potentially unacceptable health risks from contaminated media. Therefore, impacts associated with lead, arsenic, and OCP compounds chlordane and dieldrin are potentially significant. Mitigation Measure HAZ-1 is required.

Mitigation Measure

The following mitigation measure shall be implemented prior to and during project construction:

HAZ-1 Site Risk Management Plan. Prior to issuance of permits allowing any earth-disturbing activity, the developer shall prepare a site risk management plan (SRMP). The SRMP will address known and unknown environmental issues that may be encountered during development. The plan shall identify appropriate measures to be followed if contaminants are encountered during excavation including health and safety measures to reduce exposure to potentially impacted soil for construction workers and dust control measures to reduce exposure to contaminated dust particles for nearby residents. Health and safety measures shall include the required personal protective equipment (PPE) to be used by site personnel, including action levels and decision criteria for upgrading the levels of PPE. The SRMP shall also identify personnel to be notified, emergency contacts, and a sampling protocol if impacted media is encountered. The excavation and demolition contractors shall be made aware of the possibility of encountering known and unknown hazardous materials including impacted soil, soil vapor, and groundwater (if encountered), and shall be provided with appropriate contact and notification information. The plan shall include a provision stating at what point it is safe to continue with the excavation or demolition, and identify the person authorized to make that determination. Removal, transportation, and disposal of impacted soil shall be performed in accordance with applicable federal, state, and local laws, regulations, and ordinances. The plan shall be submitted for City of Hayward for review and approval.

Implementation of Mitigation Measure HAZ-1 would reduce the potential for construction workers and adjacent residences to be exposed to subsurface contaminants. Therefore, this mitigation measure will reduce impacts to construction workers, residents, and the environment from on-site contamination to less than significant levels.

LESS THAN SIGNIFICANT WITH MITIGATION INCORPORATED

- e. *For a project located within an airport land use plan or, where such a plan has not been adopted, within two miles of a public airport or public use airport, would the project result in a safety hazard for people residing or working in the project area?*
- f. *For a project near a private airstrip, would it result in a safety hazard for people residing or working in the project area?*

The nearest airport to the project site is the Hayward Executive Airport, located approximately 2.6 miles to the southwest. The project site is not located within the Hayward Executive Airport Influence Area and is located outside the existing noise level contours for the airport (Alameda County Airport Land Use Commission [ALUC] 2012). The project would not subject persons working at the site to safety hazards, and there will be no impact from potential air traffic safety risks.

NO IMPACT

- g. *Would the project impair implementation of or physically interfere with an adopted emergency response plan or emergency evacuation plan?*

The City of Hayward adopted the *Local Hazard Mitigation Plan* in 2016 (City of Hayward 2016a). Construction of the proposed project would occur within the boundary of the project site and no street closures would occur. The project does not involve the development of structures that could

City of Hayward
22626 4th Street Residential Project

potentially impair implementation of or physically interfere with an adopted emergency response plan or emergency evacuation plan. No streets or property access points would be closed, rerouted, or substantially altered during or after construction. There will be no impact.

NO IMPACT

h. Would the project expose people or structures to a significant risk of loss, injury, or death involving wildland fires, including where wildlands are adjacent to urbanized areas or where residences are intermixed with wildlands?

The project site is located in a developed urbanized area that is surrounded by residential and commercial uses and no adjacent wildlands or densely vegetated areas are located in the area that would represent a significant fire hazard. The project site is not located in a Fire Hazard Severity Zone or Very High Hazard Severity Zone for wildland fires (California Department of Forestry and Fire Protection [CAL FIRE] 2007, 2008). Therefore, the project would not expose people or structures to significant risk of loss, injury, or death involving wildland fires. There will be no impact.

NO IMPACT

9 Hydrology and Water Quality

	Potentially Significant Impact	Less than Significant with Mitigation Incorporated	Less than Significant Impact	No Impact
--	--------------------------------	--	------------------------------	-----------

Would the project:

a. Violate any water quality standards or waste discharge requirements?	<input type="checkbox"/>	<input checked="" type="checkbox"/>	<input type="checkbox"/>	<input type="checkbox"/>
b. Substantially deplete groundwater supplies or interfere substantially with groundwater recharge such that there would be a net deficit in aquifer volume or a lowering of the local groundwater table level (e.g., the production rate of pre-existing nearby wells would drop to a level that would not support existing land uses or planned uses for which permits have been granted)?	<input type="checkbox"/>	<input type="checkbox"/>	<input checked="" type="checkbox"/>	<input type="checkbox"/>
c. Substantially alter the existing drainage pattern of the site or area, including through the alteration of the course of a stream or river, in a manner that would result in substantial erosion or siltation on- or off-site?	<input type="checkbox"/>	<input checked="" type="checkbox"/>	<input type="checkbox"/>	<input type="checkbox"/>
d. Substantially alter the existing drainage pattern of the site or area, including the course of a stream or river, or substantially increase the rate or amount of surface runoff in a manner that would result in flooding on- or off-site?	<input type="checkbox"/>	<input checked="" type="checkbox"/>	<input type="checkbox"/>	<input type="checkbox"/>
e. Create or contribute runoff water that would exceed the capacity of existing or planned stormwater drainage systems or provide substantial additional sources of polluted runoff?	<input type="checkbox"/>	<input checked="" type="checkbox"/>	<input type="checkbox"/>	<input type="checkbox"/>
f. Otherwise substantially degrade water quality?	<input type="checkbox"/>	<input checked="" type="checkbox"/>	<input type="checkbox"/>	<input type="checkbox"/>

	Potentially Significant Impact	Less than Significant with Mitigation Incorporated	Less than Significant Impact	No Impact
g. Place housing in a 100-year flood hazard area as mapped on a federal Flood Hazard Boundary, Flood Insurance Rate Map, or other flood hazard delineation map?	<input type="checkbox"/>	<input type="checkbox"/>	<input checked="" type="checkbox"/>	<input type="checkbox"/>
h. Place structures in a 100-year flood hazard area that would impede or redirect flood flows?	<input type="checkbox"/>	<input type="checkbox"/>	<input checked="" type="checkbox"/>	<input type="checkbox"/>
i. Expose people or structures to a significant risk of loss, injury, or death involving flooding, including that occurring as a result of the failure of a levee or dam?	<input type="checkbox"/>	<input type="checkbox"/>	<input type="checkbox"/>	<input checked="" type="checkbox"/>
j. Result in inundation by seiche, tsunami, or mudflow?	<input type="checkbox"/>	<input type="checkbox"/>	<input type="checkbox"/>	<input checked="" type="checkbox"/>

Existing Setting

The project site is located in the San Francisco Bay Hydrologic Region, which covers approximately 4,500 square miles and encompasses 10 counties, including Alameda County. It corresponds with the boundaries of the San Francisco Regional Water Quality Control Board (SFRWQCB) Region 2 and the San Francisco Bay Area Integrated Regional Water Management Plan. The San Francisco Bay Hydrologic Region is a complex network of watersheds, marshes, rivers, creeks, reservoirs, and bays mostly draining into the San Francisco Bay and the Pacific Ocean (California Department of Water Resources 2009).

The SFRWQCB monitors surface water quality through implementation of the Water Quality Control Plan (Basin Plan) and designates beneficial uses for surface water bodies and groundwater. The project site is within the San Lorenzo Creek watershed and San Lorenzo Creek runs along the northern border of the project site. The San Lorenzo Creek Watershed drains an area of approximately 48 square miles and is one of the largest watersheds draining to the eastern shore of San Francisco Bay. The watershed begins in the East Bay hills at the Dublin Grade. San Lorenzo Creek flows generally west, entering central San Francisco Bay near Roberts Landing, west of San Lorenzo (Alameda Flood Control & Water Conservation District [ACFCWCD] 2017). The SFRWQCB Basin Plan lists 10 beneficial uses for the San Lorenzo Creek: municipal and domestic supply, freshwater replenishment, groundwater recharge, cold freshwater habitat, fish migration, fish spawning, warm freshwater habitat, wildlife habitat, water contact recreation, and noncontact water recreation (SFRWQCB 2017).

The major storm drainage facilities in Hayward are owned and maintained by the ACFCWCD, which designs and constructs drainage facilities to meet the existing and projected flood control needs. ACFCWCD also owns and operates a stormwater treatment pond in Hayward. Storm drain pipes

smaller than 30 inches are typically owned by the City of Hayward and are generally provided within local streets and easements. The storm drain system consists of gravity pipelines predominantly made of reinforced concrete, which discharge to underground storm drain lines or open channels owned by the ACFCWCD. The City of Hayward has five pump stations that pump stormwater into stormwater collection systems and/or dry creeks immediately downstream. Stormwater flows eventually drain into Mt. Eden Creek and Old Alameda Creek en route to San Francisco Bay (City of Hayward 2014a).

Stormwater runoff pollutants vary with land use, topography, and the amount of impervious surface, as well as the amount and frequency of rainfall and irrigation practices. Runoff in developed areas typically contains oil, grease, litter, and metals accumulated in streets, driveways, parking lots, and rooftops, as well as pesticides, herbicides, particulate matter, nutrients, animal waste, and other oxygen-demanding substances from landscaped areas. The highest pollutant concentrations usually occur at the beginning of the wet season during the “first flush” (California Department of Water Resources 2015).

Impact Analysis

- a. *Would the project violate any water quality standards or waste discharge requirements?*
- c. *Would the project substantially alter the existing drainage pattern of the site or area, including through the alteration of the course of a stream or river, in a manner that would result in substantial erosion or siltation on- or off-site?*
- f. *Would the project otherwise substantially degrade water quality?*

Construction Impacts

During construction of the project, existing vegetation, concrete, and asphalt materials would be removed from the site. Grading of the site would also occur. San Lorenzo Creek crosses and is adjacent to the northern boundary of the project site. The project would involve dedicating the portion of the site in and adjacent to the stream bank to the City of Hayward for use as open space and would not alter the course of the creek. Therefore, the project would not alter the course of the creek in a manner that would result in erosion or siltation on- or off-site. However, during removal of materials and grading activities, the site’s soils would be exposed to wind and water erosion that could transport sediments into local stormwater drainages and into the adjacent San Lorenzo Creek. Also, accidental spills of fluids or fuels from construction vehicles and equipment, or miscellaneous construction materials and debris, could be mobilized and transported off-site in overland flow. These contaminant sources could degrade the water quality of receiving water bodies (i.e., San Lorenzo Creek and San Francisco Bay), potentially resulting in a violation of water quality standards.

As part of Section 402 of the CWA, the US EPA has established regulations under the National Pollution Discharge Elimination System (NPDES) program to control both construction and operation (occupancy) stormwater discharges. The federal CWA was first adopted in 1972 and is intended to protect and preserve water supply and quality in the “waters of the United States.” In the Bay Area, the SFBRWQCB administers the NPDES permitting program and is responsible for developing permitting requirements. The project would be subject to the San Francisco Bay Region Municipal Regional Stormwater Permit (MRP), NPDES Permit Order No. R2-2015-0049, and the provisions set forth in Section C.3 *New Development and Redevelopment*. Under the conditions of the permitting program, the applicant will be required to eliminate or reduce non-stormwater discharges to waters of the nation, develop and implement a SWPPP for construction activities, and perform inspections

of the stormwater pollution prevention measures and control practices to ensure conformance with the site SWPPP. Because the project would disturb at least one acre of land, the project must provide stormwater treatment during construction and would be required to obtain coverage under the General Permit for Discharges of Storm Water Associated with Construction Activity (Construction General Permit Order 2009-0009-DWQ or 2009-0009-DWQ General Permit). Further, in accordance with HMC Chapter 10, Article 8 (Grading and Clearing), all grading activities must be conducted in a manner that will minimize the potential for erosion from the site. If requested by the City engineer, the project applicant would be required to prepare and implement an Erosion and Sediment Control Plan that specifies control techniques that would prevent erosion during construction.

Although compliance with existing laws and regulations would minimize the potential for water quality degradation during construction activities, due to the proximity of San Lorenzo Creek and the lack of detailed drainage improvement information for the proposed project at this time, Mitigation Measure HYD-1 is required to ensure that drainage improvement are properly designed and that construction and operation of the proposed project would not result in overland flow from the project site entering San Lorenzo Creek directly. With compliance with construction-related water quality and erosion control requirements and implementation of Mitigation Measure HYD-1, construction of the project would not violate any water quality standards, substantially alter the drainage pattern of the area such that substantial erosion or siltation would occur and would not degrade water quality of the adjacent San Lorenzo Creek or other water bodies. Impacts related to surface water quality during construction will be less than significant.

Water Well Removal

According to the Phase I ESA, two elevated water tanks were depicted in the northern portion of the project site (north of B Street) on Sanborn maps. The concrete foundation to one of the tanks was observed during one of the site visits and appeared to be associated with a domestic water well. It is unknown whether the other observed water storage tank was associated with a separate well. It is unclear if the water tank was abandoned properly under permit or if other domestic wells associated with the former residences are present. According to the preliminary demolition plan (RJA 2017a), existing wells on-site would be removed. Wells that have not been abandoned properly under permit are a potential pathway for groundwater contamination. However, HMC Section 5.4.10 regulates the destruction or abandonment of wells. This article implements the "Well Standards Ordinance of the City of Hayward" and gives jurisdiction to the Alameda County Public Works Department to regulate the destruction or abandonment of wells within the City of Hayward in accordance with Alameda County Code requirements. Under this ordinance, the project applicant would be required to obtain approval from the Alameda County Public Works Department to abandon the well, or confirm that the existing on-site wells were previously abandoned under permit, prior to issuance of an occupancy permit. The applicant would also be required to adhere to standards for well destruction, as verified by the Public Works Department, which would ensure no groundwater contamination would occur during well removal. With adherence to City and County requirements, impacts related to well removal will be less than significant.

Operational Impacts

The project would alter the drainage pattern of the site by adding approximately 95,281 square feet of impervious surface area. Increasing the total area of impervious surfaces can result in a greater potential to introduce pollutants to receiving waters. Urban runoff can carry a variety of pollutants,

including oil and grease, metals, sediment, and pesticide residues from roadways, parking lots, rooftops, and landscaped areas, depositing them into adjacent waterways via the storm drain system (US EPA 2003).

Stormwater discharge during operation is regulated by the MRP issued by the RWQCB, pursuant to NPDES regulations. Water quality in stormwater runoff is regulated locally by the Alameda County Clean Water Program, which includes the C.3 provisions set by the SFRWQCB. Provision C.3 of the MRP addresses post-construction stormwater requirements for new development and redevelopment projects that add and/or replace 10,000 square feet or more of impervious area. Because the project would replace in excess of 10,000 square feet of the impervious surface of the project site, it must comply with the C.3 provisions set by the SFRWQCB. Therefore, the project must meet certain criteria including 1) incorporate site design, source control, and stormwater treatment measures into the project design; 2) minimize the discharge of pollutants in stormwater runoff and non-stormwater discharge; and 3) minimize increases in runoff flows as compared to pre-development conditions. A Stormwater Control Plan (SCP) that details the site control, source control, and stormwater measures that would be implemented at the site must be submitted to the City. In addition, Low Impact Development (LID) requirements apply. The Alameda County Clean Water Program's C.3 Technical Guidance document (2016) provides guidance on how to meet the C.3 requirements.

Pursuant to C.3 requirements, the project is required to include design features that would reduce impacts associated with the increased impervious surfaces. The proposed project would incorporate silva cells throughout the project site and two stormwater bioretention areas are proposed in the northern portion of the site to capture and treat runoff. By adhering to the provisions of NPDES Section C.3, the SWPPP, and the stormwater control plan, the potential for adverse effects on water quality and or in the violation of water quality standards or waste discharge requirements during construction or operation would be minimized. However, due to the proximity of San Lorenzo Creek, Mitigation Measure HYD-1 and Mitigation Measure HYD-2 are required to ensure that drainage improvements for the proposed project are properly designed and maintained. Compliance with existing laws and regulations and implementation of required mitigation would ensure that the potential for the project to violate water quality standards or substantially degrade water quality would be minimized. Impacts related to surface water quality during operation would be less than significant.

Mitigation Measures

The following mitigation measures would be required to avoid or reduce the project's potentially significant impacts to surface water quality.

HYD-1 Design-level Drainage Analysis and Minimization of Runoff. The applicant shall conduct a design-level drainage analysis prior to issuance of a grading permit that shall identify existing drainage patterns across the project site and existing off-site stormwater discharge locations. The drainage analysis shall quantify the existing and predicted post-construction peak runoff rates and amounts both on-site and off-site immediately downgradient of the project site. The drainage analysis shall identify any changes to the location of down-gradient discharge of stormwater runoff and any potential impacts on off-site property that would result from those changes. Stormwater control measures shall be developed to maximize on-site infiltration of stormwater and minimize off-site stormwater discharge. These stormwater control measures shall be designed to achieve conformance with MRP C.3 requirements and to ensure that post-development

stormwater discharge rates and amounts to off-site locations, including San Lorenzo Creek, are maintained at or below pre-development levels. In addition, on-site drainage improvements shall be designed to ensure that runoff leaving the project site does not flow over the bank of San Lorenzo Creek. The stormwater control measures may include, as necessary, additional or expanded above-ground retention and/or detention basins, stormwater collection tanks, subsurface infiltration devices such as cisterns with permeable bottoms or perforated pipes, permeable pavement, and vegetated swales. The stormwater control measures required by this mitigation may be used, in whole or in part, to satisfy the erosion and runoff control standards of the NPDES-required SWPPP.

The design-level drainage analysis shall be submitted to and approved by ACPWA prior to issuance of a grading permit. The design-level drainage analysis shall be accompanied by a Drainage Review Checklist provided by ACPWA. The drainage analysis and Drainage Review Checklist shall demonstrate that curb elevations are not less than 1.25 feet above the hydraulic grade line and not lower than the energy grade line, that the MRP C.3 requirements are met, that required riparian setbacks have been implemented, that no surface runoff will flow over the existing bank of San Lorenzo Creek, that outfall structures to the channel conform to ACFCD standards, and that the rates and amounts of post-development stormwater discharge are maintained at pre-development levels.

HYD-2 Stormwater Control Plan, Operation and Maintenance Plan, and Maintenance

Agreements. Prior to issuance of grading permits, the applicant shall submit a Stormwater Control Plan, prepared by a registered professional engineer, addressing the MRP C.3 post-construction runoff requirements. The plan shall include the location of the drainage facilities and the materials used to construct those facilities. A report with supporting calculations shall also be provided. The Stormwater Control Plan shall be reviewed by a licensed Geotechnical Engineer to ensure conformance with the Preliminary Geotechnical Investigation (ENGEO 2017) or Engineering Geology Report. Prior to issuance of grading permits, the applicant shall submit an Operation and Maintenance Plan to ACPWA for review and approval. The plan shall be prepared by a registered Professional Engineer and include, at a minimum, the following:

- A site map identifying all structural Stormwater Control Measures requiring O&M practices to function as designed
- O&M procedures for each structural Stormwater Control Measure including, but not limited to, LID facilities, retention/detention basins, and proprietorship devices, and
- The O&M plan shall include short- and long-term maintenance requirements, recommended frequency of maintenance, and estimated cost for maintenance.

Prior to issuance of grading permits, the applicant shall enter into a Maintenance Agreement with Alameda County. The applicant shall submit a signed and notarized Maintenance Agreement to ACPWA for review and approval. The agreement shall clearly identify the responsible party for ongoing maintenance of structural Stormwater Control Measures. The Agreement shall contain provisions for an annual report to be prepared by a registered Professional Engineer. The annual report shall be submitted to ACPWA, for review and approval, no later than August 15th. All recommended maintenance shall be completed by October 15th of that same year. If maintenance is required, certification shall be provided that all recommended maintenance has been completed before the start of the rainy season.

With implementation of the above measures, impacts related to surface water quality, drainage pattern alteration, and increased erosion and sedimentation would be less than significant.

LESS THAN SIGNIFICANT WITH MITIGATION INCORPORATED

- b. Would the project substantially deplete groundwater supplies or interfere substantially with groundwater recharge such that there would be a net deficit in aquifer volume or a lowering of the local groundwater table level (e.g., the production rate of pre-existing nearby wells would drop to a level that would not support existing land uses or planned uses for which permits have been granted)?*

As discussed in Section 18, *Utilities and Service Systems*, the project would receive its water from the City of Hayward. Hayward receives its water from the Hetch Hetchy regional water system, which is owned and operated by the San Francisco Public Utilities Commission (SFPUC) (City of Hayward 2010, SFPUC 2017). Hayward does not currently use groundwater to meet any portion of the City's water demand and does not plan to in the future (City of Hayward 2010). Therefore, the project would not rely on groundwater for its water supply and would not increase groundwater usage such that a net deficit in aquifer volume would occur.

Development under the project does not include installation of new groundwater wells or use of groundwater from existing wells. Although existing wells may be present on-site, as noted above in the response to questions (a), (c), and (f), these wells would be removed and groundwater from these wells would not be used. Therefore, the project would have a less than significant impact on groundwater supplies.

The project would increase the total area of impervious surfaces on the project site by approximately 95,280 square feet. However, the construction of stormwater management bio-retention areas would allow much of the stormwater runoff from the project site to infiltrate into the ground surface and would not substantially interfere with groundwater recharge of water supply aquifers. Therefore, the project would not substantially interfere with groundwater recharge. Impacts related to groundwater will be less than significant.

LESS THAN SIGNIFICANT IMPACT

- d. Would the project substantially alter the existing drainage pattern of the site or area, including the course of a stream or river, or substantially increase the rate or amount of surface runoff in a manner that would result in flooding on- or off-site?*
- e. Would the project create or contribute runoff water that would exceed the capacity of existing or planned stormwater drainage systems or provide substantial additional sources of polluted runoff?*

The project site is bordered by San Lorenzo Creek to the north. The creek is a natural channel owned and maintained by the ACFCWD. The project would not alter the course of the creek. The area around the creek would be kept as an open space area in compliance with ACFCWD and ACPWA requirements, as specified in Mitigation Measure BIO-2 and Mitigation Measure GEO-1. Implementation of Mitigation Measure HYD-1 and HYD-2 would ensure that surface runoff from the project site would not flow over the existing bank and into the creek; rather, project runoff would be directed to the existing stormwater pipes and outlets that are part of the local storm drain system.

To help reduce stormwater run-off, the project would incorporate silva cells throughout the project site. Additionally, two stormwater bioretention areas are proposed in the northern portion of the

City of Hayward
22626 4th Street Residential Project

site to capture and treat runoff. According to the preliminary stormwater treatment plan (RJA 2017b), the project would involve an effective impervious area³ of approximately 101,580 square feet. In accordance with Alameda County C.3 requirements (see discussion above under questions a, c, and f), the project would be required to provide 4,063 square feet of treatment area. The proposed project would provide 5,035 square feet of treatment area. Therefore, it is consistent with the County's C.3 requirements. Thus, the project would not substantially increase stormwater discharge, substantially alter drainage patterns on-site or the surrounding area, and would not contribute runoff that would exceed the capacity of the existing on-site or off-site stormwater drainage system. Impacts will be less than significant.

LESS THAN SIGNIFICANT WITH MITIGATION INCORPORATED

- g. Would the project place housing in a 100-year flood hazard area as mapped on a federal Flood Hazard Boundary, Flood Insurance Rate Map, or other flood hazard delineation map?*
- h. Would the project place structures in a 100-year flood hazard area that would impede or redirect flood flows?*

The Federal Emergency Management Agency (FEMA) is responsible for the preparation of Flood Insurance Rate Maps (FIRMs). These maps present flood hazard, expressed as areas that are subject to inundation in a storm with either a one percent Annual Exceedance Probability, also referred to as a 100-year flood, or a 0.2 percent Annual Exceedance Probability (500-year flood). The majority of the project site is located outside a FEMA designed flood zone. However, a small portion of the site in the northwest corner is located within the 100-year FEMA-designated floodplain of the San Lorenzo Creek (FEMA FIRM Map #06001C0287G, effective date August 3, 2009). This portion of the project would not involve development and would be preserved as open space. Therefore, none of the residential structures would be located within a flood zone and impacts concerning flood hazards will be less than significant.

LESS THAN SIGNIFICANT IMPACT

- i. Would the project expose people or structures to a significant risk of loss, injury, or death involving flooding, including that occurring as a result of the failure of a levee or dam?*

The closest dam to the project site is the South Reservoir dam located approximately one mile northwest of the site (City of Hayward 2014b). The project site is not located inside the inundation area of the South Reservoir dam or any other nearby dams. Therefore, development of the proposed project would not expose people or structures to a significant risk of loss, injury, or death involving flooding, including flooding as a result of the failure of a levee or dam. No impact will occur.

NO IMPACT

- j. Would the project result in inundation by seiche, tsunami, or mudflow?*

The nearest largest body of water to the project is the San Francisco Bay, which is approximately five miles to the west of the project site. The project is also over three miles from Lake Chabot to the northwest. Since the project site is not near any large bodies of water and is five miles inland

³ Effective impervious area includes all roofs, hardscapes, and streets plus 10 percent of the area that is in landscape that would drain to treatment areas.

Environmental Checklist
Hydrology and Water Quality

from the San Francisco Bay, the project site would not be subject to inundation by seiche, tsunami, or mudflow. No impact will occur.

NO IMPACT

This page intentionally left blank.

10 Land Use and Planning

	Potentially Significant Impact	Less than Significant with Mitigation Incorporated	Less than Significant Impact	No Impact
Would the project:				
a. Physically divide an established community?	<input type="checkbox"/>	<input type="checkbox"/>	<input type="checkbox"/>	<input checked="" type="checkbox"/>
b. Conflict with any applicable land use plan, policy, or regulation of an agency with jurisdiction over the project (including but not limited to the general plan, specific plan, local coastal program, or zoning ordinance) adopted for the purpose of avoiding or mitigating an environmental effect?	<input type="checkbox"/>	<input type="checkbox"/>	<input checked="" type="checkbox"/>	<input type="checkbox"/>
c. Conflict with an applicable habitat conservation plan or natural community conservation plan?	<input type="checkbox"/>	<input type="checkbox"/>	<input type="checkbox"/>	<input checked="" type="checkbox"/>

a. Would the project physically divide an established community?

The project would involve development of 41 single-family residences on approximately 5.1 acres of land surrounded by other single-family dwellings and commercial uses. No operational or structural changes are proposed that would separate connected areas physically or socially, nor are any linear features, new roads or other barriers to movement proposed. There will be no impact.

NO IMPACT

b. Would the project conflict with any applicable land use plan, policy, or regulation of an agency with jurisdiction over the project (including but not limited to the general plan, specific plan, local coastal program, or zoning ordinance) adopted for the purpose of avoiding or mitigating an environmental effect?

The project’s consistency with the City of Hayward’s General Plan and Zoning Ordinance are discussed below.

Hayward 2040 General Plan

The southern portion of the project site south of B Street has a General Plan land use designation of LDR (Low Density Residential) and the portion of the project site north of B Street has land use designations of LDR (northern half) and MDR (Medium Density Residential) (southern half). As described in the City’s General Plan, the LDR designation generally applies to suburban areas. The LDR designation allows for detached single-family residences; second units; home occupations; parks, recreation facilities, open space, and trails; community gardens; and compatible public and quasi-public uses. Development standards for residential uses under the LDR designation include

City of Hayward
22626 4th Street Residential Project

density's ranging from 4.3 to 8.7 dwelling units per net acre. The MDR designation generally applies to suburban and urban areas that contain a mix of housing types. The MDR designation allows for single-family residences, second units, duplexes, triplexes, fourplexes, townhomes, multi-story apartment and condominium buildings, and ancillary structures. Development standards for residential uses under the MDR designation include density's ranging from 8.7 to 17.4 dwelling units per net acre. The City's General Plan indicates that net acreage is calculated by netting out public and private streets and publicly dedicated open space from the gross acreage.

The project would involve the development of 41 single-family residences on a 5.1 acre site with a net acreage of 4.16 acres, including 3.37 net acres on the portion of the project site designated LDR and 0.79 net acres on the portion of the project site designated MDR. Based on the maximum density of 8.7 units per acre in the LDR designation, the project would be allowed up to 29.3 units (3.37 acres x 8.7 units per acre = 29.3 units), and based on the maximum density of 17.4 units per acre in the MRD designation, the project would be allowed up to 13.8 units (0.79 acres x 17.4 units per acre = 13.8 units). Therefore, overall, a maximum of 43 units could be developed. The project involves development of 41 units which is within the acceptable density range. Therefore, the project will be consistent with General Plan's density standards for the project site.

City of Hayward Zoning Ordinance

The project site is zoned RS (Single Family Residential). The RS District is intended to accommodate only single-family residences and the appurtenant community services (HMC Section 10-1.205). The project includes a request to rezone the existing RS-zoned parcels into a new PD District to accommodate the proposed development. A PD rezone is necessary for the project as proposed because the project does not otherwise meet the RS District development standards related to lot size and yard size. The project involves lot sizes ranging from 2,012 to 5,020 square feet. All but one of the lots would be smaller than the minimum lot size requirement of 5,000 square feet required by HMC Section 10-1.230. Additionally, only 10 of the 41 units would meet or exceed the 20-foot rear yard setback required by HMC Section 10-1.230. Finally, the combined driveways and paving surface area in the front yards of 17 of the 41 residences exceed a maximum of 50 percent of the required front area, contrary to what is required by Section 10-1.245(k)(3)(d). If the project is approved, the proposed development standards and residential land use would be consistent with the PD zoning provisions of the HMC and would not conflict with the City's General Plan. Therefore, impacts of the project will be less than significant.

LESS THAN SIGNIFICANT IMPACT

- c. *Would the project conflict with an applicable habitat conservation plan or natural community conservation plan?*

As discussed in Section 4, *Biological Resources*, the project site is not part of or near an existing Habitat Conservation Plan or Natural Communities Conservation Plan or any other local, regional, or state habitat conservation plan. Therefore, the proposed project would not conflict with the provisions of an adopted Habitat Conservation Plan, Natural Community Conservation Plan, or other approved local, regional, or state habitat conservation plan. Therefore, no related impact will occur.

NO IMPACT

11 Mineral Resources

	Potentially Significant Impact	Less than Significant with Mitigation Incorporated	Less than Significant Impact	No Impact
Would the project:				
a. Result in the loss of availability of a known mineral resource that would be of value to the region and the residents of the state?	<input type="checkbox"/>	<input type="checkbox"/>	<input type="checkbox"/>	<input checked="" type="checkbox"/>
b. Result in the loss of availability of a locally important mineral resource recovery site delineated on a local general plan, specific plan, or other land use plan?	<input type="checkbox"/>	<input type="checkbox"/>	<input type="checkbox"/>	<input checked="" type="checkbox"/>

- a. *Would the project result in the loss of availability of a known mineral resource that would be of value to the region and the residents of the state?*
- b. *Would the project result in the loss of availability of a locally important mineral resource recovery site delineated on a local general plan, specific plan, or other land use plan?*

Hayward’s principal mineral resources are stone, limestone, clay, fire clay, halite, and salt. The only designated mineral resource sector of regional significance in Hayward is the La Vista Quarry, operated roughly three miles southeast of the project site (City of Hayward 2014b). Future quarrying is unlikely due to environmental impacts and stringent permitting. The project would involve the construction of 41 single-family residences and would not result in a loss of available minerals. There will be no impact.

NO IMPACT

This page intentionally left blank.

12 Noise

	Potentially Significant Impact	Less than Significant with Mitigation Incorporated	Less than Significant Impact	No Impact
Would the project result in:				
a. Exposure of persons to or generation of noise levels in excess of standards established in the local general plan or noise ordinance, or applicable standards of other agencies?	<input type="checkbox"/>	<input checked="" type="checkbox"/>	<input type="checkbox"/>	<input type="checkbox"/>
b. Exposure of persons to or generation of excessive groundborne vibration or groundborne noise levels?	<input type="checkbox"/>	<input type="checkbox"/>	<input checked="" type="checkbox"/>	<input type="checkbox"/>
c. A substantial permanent increase in ambient noise levels above those existing prior to implementation of the project?	<input type="checkbox"/>	<input checked="" type="checkbox"/>	<input type="checkbox"/>	<input type="checkbox"/>
d. A substantial temporary or periodic increase in ambient noise levels in the project vicinity above levels existing without the project?	<input type="checkbox"/>	<input checked="" type="checkbox"/>	<input type="checkbox"/>	<input type="checkbox"/>
e. For a project located in an airport land use plan or, where such a plan has not been adopted, within two miles of a public airport or public use airport, would the project expose people residing or working in the project area to excessive noise levels?	<input type="checkbox"/>	<input type="checkbox"/>	<input type="checkbox"/>	<input checked="" type="checkbox"/>
f. For a project near a private airstrip, would it expose people residing or working in the project area to excessive noise?	<input type="checkbox"/>	<input type="checkbox"/>	<input type="checkbox"/>	<input checked="" type="checkbox"/>

Fundamentals of Noise

Noise is unwanted sound that disturbs human activity. Environmental noise levels typically fluctuate over time, and different types of noise descriptors are used to account for this variability. Noise level measurements include intensity, frequency, and duration, as well as time of occurrence. Noise level (or volume) is generally measured in decibels (dB) using the A-weighted sound pressure level (dBA). Because of the way the human ear works, a sound must be about 10 dBA greater than the reference sound to be judged as twice as loud. In general, a 3 dBA change in community noise levels is noticeable, while 1 to 2 dBA changes generally are not perceived. Quiet suburban areas typically

City of Hayward
22626 4th Street Residential Project

have noise levels in the range of 40 to 50 dBA, while arterial streets are in the 50 to 60 or more dBA range. Normal conversational levels are in the 60 to 65 dBA range, and ambient noise levels greater than 65 dBA can interrupt conversations.

Noise levels typically attenuate at a rate of 6 dBA per doubling of distance from point sources (such as construction equipment). Noise from lightly traveled roads typically attenuates at a rate of about 4.5 dBA per doubling of distance. Noise from heavily traveled roads typically attenuates at about 3 dBA per doubling of distance, while noise from a point source typically attenuates at about 6 dBA per doubling of distance. Noise levels may also be reduced by the introduction of intervening structures. For example, a single row of buildings between the receptor and the noise source reduces the noise level by about 5 dBA, while a solid wall or berm that breaks the line-of-sight reduces noise levels by 5 to 10 dBA. The construction style for dwelling units in California generally provides a reduction of exterior-to-interior noise levels of about 30 dBA with closed windows (Federal Highway Administration [FHWA] 2006).

In addition to the instantaneous measurement of sound levels, the duration of sound is important because sounds that occur over a long period of time are more likely to be an annoyance or cause direct physical damage or environmental stress. One of the most frequently used noise metrics that considers both duration and sound power level is the equivalent noise level (Leq). The Leq is defined as the single steady A-weighted level that is equivalent to the same amount of energy as that contained in the actual fluctuating levels over a period of time (essentially, the average noise level). Typically, Leq is summed over a one-hour period. Lmax is the highest RMS (root mean squared) sound pressure level within the measurement period, and Lmin is the lowest RMS sound pressure level within the measurement period.

The time period in which noise occurs is also important since nighttime noise tends to disturb people more than daytime noise. Community noise is usually measured using Day-Night Average Level (Ldn), which is the 24-hour average noise level with a 10-dBA penalty for noise occurring during nighttime (10:00 p.m. to 7:00 a.m.) hours, or Community Noise Equivalent Level (CNEL), which is the 24-hour average noise level with a 5 dBA penalty for noise occurring from 7:00 p.m. to 10:00 p.m. and a 10 dBA penalty for noise occurring from 10:00 p.m. to 7:00 a.m. Noise levels described by Ldn and CNEL typically do not differ by more than 1 dBA. In practice, CNEL and Ldn are often used interchangeably.

The relationship between peak hourly Leq values and associated Ldn/CNEL values depends on the distribution of traffic over the entire day. There is no precise way to convert a peak hour Leq to Ldn or CNEL. However, in urban areas near heavy traffic, the peak hour Leq is typically 2 to 4 dBA lower than the daily Ldn/CNEL. In less heavily developed areas, such as suburban areas, the peak hour Leq is often roughly equal to the daily Ldn/CNEL. For rural areas with little nighttime traffic, the peak hour Leq will often be 3 to 4 dBA greater than the daily Ldn/CNEL value (California State Water Resources Control Board [SWRCB] 1999). The project site is located in a suburban area. Therefore, the Ldn/CNEL in the area would be roughly equal to the peak hour Leq.

Fundamentals of Vibration

Vibrating objects in contact with the ground radiate energy through that medium. If a vibrating object is massive enough and/or close enough to the observer, its vibrations are perceptible. The rumbling sound caused by the vibration of room surfaces is called groundborne noise. The ground motion caused by vibration is measured in vibration decibels (VdB). The background vibration velocity level in residential areas is usually around 50 VdB. The vibration velocity level threshold of perception for humans is approximately 65 VdB. A vibration velocity level of 75 VdB is the

approximate dividing line between barely perceptible and distinctly perceptible levels for many people. Most perceptible indoor vibration is caused by sources within buildings such as the operation of mechanical equipment, movement of people, or the slamming of doors. Typical outdoor sources of perceptible groundborne vibration are construction equipment, steel-wheeled trains, and traffic on rough roads. If a roadway is smooth, the groundborne vibration from traffic is rarely perceptible. The range of interest is from approximately 50 VdB, which is the typical background vibration velocity level, and 100 VdB, which is the general threshold where minor damage can occur in fragile buildings.

Some land uses are more sensitive to ambient noise and vibration levels than other uses due to the amount of noise exposure and the types of activities involved. For example, residences, motels, hotels, schools, libraries, churches, nursing homes, auditoriums, museums, cultural facilities, parks, and outdoor recreation areas are more sensitive to noise than commercial and industrial land uses. The nearest sensitive receptors to the project site are single-family residences located adjacent to the project site along Chestnut Street and 4th Street and the Faith Ringgold School of Arts and Science located approximately 400 feet southeast of the project site.

Existing Setting

The noise environment on the project site is dominated by noises typical of residential neighborhoods, including vehicular traffic, pedestrian conversations, and doors slamming. Noise from wildlife (e.g., bird song) is also audible at the project site. On February 15, 2018, Rincon Consultants, Inc. performed two 15-minute weekday noise measurements using an ANSI Type II integrating sound level meter. Both measurements were taken during rush hour, between 4:00 p.m. and 6:00 p.m. The noise monitoring results are summarized in Table 7. Figure 10 shows the locations of the noise measurements.

Table 7 Noise Measurement Results

Site	Measurement Location	Sample Times	Primary Noise Source	Leq[15] (dBA) ¹
1	Along Chestnut St. to the northeast of project site.	4:00 PM – 4:15 PM	B St. (250 feet from centerline)	52.7
2	Along 4th St. on the southwestern corner of project site.	4:20 PM – 4:35 PM	4th St. (15 feet from centerline)	66.3
3	Along 4th St. near northwestern corner of project site.	4:44 PM – 4:55 PM	4th St. (20 feet from centerline)	66.0

See Figure 10 for a map of Noise Measurement Locations.

¹ The equivalent noise level (Leq) is defined as the single steady A-weighted level that is equivalent to the same amount of energy as that contained in the actual fluctuating levels over a period of time (essentially, the average noise level). For this measurement, the Leq was over a 15-minute period (Leq [15]).

Source: Rincon Consultants, field measurements conducted on February 15, 2017, using ANSI Type II Integrating sound level meter. See Appendix C

City of Hayward
22626 4th Street Residential Project

Figure 10 Noise Measurement Locations



Imagery provided by Google and its licensors © 2018.

Fig. 4 Noise Measurement Locations

Regulatory Setting

The Hayward 2040 General Plan states the highest level of exterior noise exposure regarded as “normally acceptable” for single-family residences is 60 dB Ldn. Ldn or Day Night Average is an average 24-hour noise measurement that factors day and night noise levels. The City’s General Plan also states the maximum acceptable interior noise level for all new residential units is 45 dB Ldn.

Article 1 of Chapter 4 of the HMC includes the City’s noise regulations. HMC Section 4-1.03.4 includes the following regulations for construction and alteration of structures and landscaping activities:

“Unless otherwise provided pursuant to a duly-issued permit or a condition of approval of a land use entitlement, the construction, alteration, or repair of structures and any landscaping activities, occurring between the hours of 10:00 a.m. and 6:00 p.m. on Sundays and holidays, and 7:00 a.m. and 7:00 p.m. on other days, shall be subject to the following:

- (a) No individual device or piece of equipment shall produce a noise level exceeding eighty-three (83) dBA at a distance of twenty-five (25) feet from the source. If the device or equipment is housed within a structure on the property, the measurement shall be made outside the structure at a distance as close as possible to twenty-five (25) feet from the equipment.
- (b) The noise level at any point outside of the property plane shall not exceed eighty-six (86) dBA.
- (c) During all other times, the decibel levels set forth in Section 4-1.03.1 shall control.”

Impact Analysis

- a. *Would the project result in exposure of persons to or generation of noise levels in excess of standards established in the local general plan or noise ordinance, or applicable standards of other agencies?*
- c. *Would the project result in a substantial permanent increase in ambient noise levels above levels existing without the project?*
- d. *Would the project result in a substantial temporary or periodic increase in ambient noise levels in the project vicinity above levels existing without the project?*

The proposed project could generate temporary noise increases during construction and long-term increases associated with project operation.

Construction Noise

Noise levels from construction of the project would result from construction activities on-site and traffic noise from construction vehicles. Nearby noise-sensitive land uses, including the single-family residences adjacent to the project site and the school located approximately 400 feet southeast of the project site, would be exposed to temporary construction noise during development of the project. Noise impacts are a function of the type of activity being undertaken and the distance to the receptor location. Table 8 shows typical noise levels at construction sites.

Table 8 Typical Noise Levels at Construction Sites

Equipment On-Site	Typical Noise Level (dBA)			
	25 Feet from the Source	50 Feet from the Source	100 Feet from the Source	400 Feet from the Source
Air Compressor	87	81	75	63
Backhoe	86	80	74	62
Concrete Mixer	91	85	79	67
Crane, mobile	89	83	77	65
Dozer	91	85	79	67
Jack Hammer	94	88	82	70
Paver	95	89	83	71
Saw	82	76	70	58
Truck	94	88	82	70

Noise levels assume a noise attenuation rate of 6 dBA per doubling of distance.
Source: Federal Transit Administration (FTA) 2006.

The distance to the nearest sensitive receptors to the project site, single-family homes located adjacent to the project site along Chestnut Street and 4th Street, is approximately 50 feet. Typical construction noise levels at 50 feet from the source would range from about 76 to 89 dBA. Such levels would exceed ambient noise and would be audible on adjacent properties, including residences immediately west and south of the project site. However, construction activity would not involve pile driving or major excavation, which would generate especially high noise levels. In addition, construction activity during the City's allowed hours of 7 a.m. to 7 p.m. on Mondays through Saturdays, and 10 a.m. to 6 p.m. on Sundays and holidays, would be subject to limits on noise levels. Pursuant to HMC Section 4-1.03.4, the noise level from construction activity may not exceed 86 dBA at any point outside of the property plane. Therefore, construction would not occur during recognized sleep hours and would not have a substantial adverse effect on nearby residents.

At the school located approximately 400 feet from the project site, construction activity would generate estimated noise levels between 62 and 71 dBA. Although this estimate is conservative as it does not account for noise attenuation from the presence of intervening structures, such noise levels may exceed existing ambient noise levels experienced at the school. Instantaneous construction noise approaching 71 dBA during normal school hours could disturb students in classrooms or outdoor activity areas. Therefore, construction-related noise could result in a substantial temporary or periodic increase in ambient noise levels. With implementation of Mitigation Measure N-1 (included at the end of this section) to control noise from construction activity, this impact would be reduced to a less-than-significant level.

Operational Noise

Operational noise associated with the project would be typical of residential uses in a residential neighborhood and would not have a significant impact on ambient noise levels. Operation of the project would not result in a substantial temporary or periodic increase in ambient noise levels. Impacts would be less than significant.

Roadway Noise

The proposed project would increase vehicle trips to and from the project site and therefore would increase traffic-related noise on roadways surrounding the site. Roadway noise impacts were analyzed for 4th Street and B Street as these roadways are located directly adjacent to the site and would be used by vehicles traveling to and from the site.

Because the City has not adopted standards that regulate increases in roadway noise caused by projects, this analysis uses recommendations contained in the FTA's *Transit Noise and Vibration Impact Assessment* (2006). These federal guidelines are used as guidance to determine whether or not the project's effect on roadway noise would represent a substantial permanent increase. Using the FTA criteria, the allowable noise exposure increase is based on the existing ambient noise level. Roadways with lower ambient noise levels have a higher allowable increase, while roadways with a higher ambient noise level are allowed a lower noise increase. Traffic-related noise increases would constitute a significant impact if roadway noise levels exposure for nearby receptors would increase by more than the levels indicated in Table 9.

Table 9 Significance of Changes in Operational Roadway Noise Exposure

Existing Noise Exposure (dBA Ldn or Leq)	Allowable Noise Exposure Increase (dBA Ldn or Leq)
45-50	7
50-55	5
55-60	3
60-65	2
65-74	1
75+	0

Source: Federal Transit Administration (FTA) 2006

As shown in on Table 7, the existing peak hour noise level on 4th Street is approximately 66.3 dBA. Noise levels at 250 feet from the B Street roadway centerline were measured at 52.7 dBA. Assuming a 3 dBA noise attention per doubling of distance for roadway noise, noise levels on B Street at the nearest sensitive receptors approximately 50 feet from the B Street roadway centerline are approximately 66.7 dBA. According the criteria shown in Table 9, for roadways with existing noise levels between 65 and 74 dBA, a one dBA increase in roadway noise resulting from the project would constitute a significant impact.

As shown in Table 16, the project would generate an estimated 34 a.m. peak hour trips and 43 p.m. peak hour trips. Modeling of traffic noise by Rincon Consultants, Inc. indicates that in general, regardless of the existing traffic volume on a given roadway, a 10 percent increase in traffic volume would raise traffic noise by approximately 0.4 dBA. As shown on Table 10, the proposed project would increase traffic volumes by less than 10 percent on 4th Street and B Street. Therefore, the project would increase noise levels by less than 0.4 dBA, which is below the FTA criteria of an increase in one dBA that would result in a significant noise increase. Impacts related to traffic noise will be less than significant.

Table 10 Daily Trips on Area Roadways

Road Segment	Existing AM Peak Hour Trips	Existing Plus Project AM Peak Hour Trips ¹	Existing PM Peak Hour Trips	Existing Plus Project PM Peak Hour Trips ²
4th Street between A Street and B Street	666	700 (5% increase)	720	763 (6% increase)
4th Street between B Street and C Street	447	481 (8% increase)	507	550 (8% increase)
B Street between 4th Street and Chestnut Street	1,333	1,367 (3% increase)	1,308	1,385 (6% increase)

¹ Conservatively assumes all 34 project-generated AM trips would travel on roadway segment

² Conservatory assumes all 43 project-generated PM trips would travel on roadway segment

Source: Figure 3, Kittelson and Associates 2018 (Appendix D)

Exposure of New Residents to Noise

The California Supreme Court in a December 2015 opinion (*BIA v. BAAQMD*) confirmed that CEQA is concerned with the impacts of a project on the environment, not the effects the existing environment may have on a project. Nevertheless, the State of California and City of Hayward have policies that address existing conditions (e.g., ambient noise) affecting a proposed project, which are addressed below.

The project would locate new residences next to arterial roadways (4th Street and B Street) that generate traffic noise. Therefore, the project could result in exposure of future residents to noise levels in excess of standards established in the City's General Plan. As shown on Table 7, noise levels along 4th Street were measured at 66.3 and 60.0 dBA peak hour Leq measured at between 15 and 20 feet from the roadway centerline.

The proposed residences closet to 4th Street would be set back approximately 50 feet from the roadway centerline. Assuming a noise attenuation of 3 dBA per doubling of distance for roadway noise, these residences would experience noise levels between 61.1 and 62.0 dBA Leq. Therefore, this future residence may be exposed to noise levels above the acceptable exterior noise level for single-family residences of 60 dB Ldn in the City's General Plan.⁴ Assuming noise levels on B Street are similar to noise levels on 4th, the residences closed to B Street may also experience noise levels above 60 dB Ldn. Other proposed residences would be set back from 4th Street and B Street and would experience noise attenuation as the result of the placement of the new residences and intervening structures and as such, the noise exposure from vehicular traffic would be reduced for the interior residences.

To avoid adverse noise exposure, the project is required to attenuate interior noise so that it does not exceed 45 dBA Ldn. The California Building Code (CBC) requires that interior noise levels for new residences be below 45 dBA CNEL (California Building Standards Commission 2017). In order to comply with CBC requirements, the project applicant is required to design the structure such that interior levels of 45 dBA CNEL are achieved. This requirement would be included as a condition of approval of the project to ensure compliance with California Building Code. With compliance with existing regulations, the proposed project will not result in exposure of future residents to noise levels in excess of standards established in the City's General Plan.

⁴ As noted above under "Fundamentals of Noise," in suburban areas, the peak hour Leq is often roughly equal to the daily Ldn. The project site is located in a suburban area; therefore, the Ldn in the area would be roughly equal to the peak hour Leq.

Mitigation Measure

The following mitigation measure would be required to reduce the exposure of sensitive receptors to construction noise, to the extent feasible.

- N-1 Construction Noise Reduction Measures.** The applicant shall apply the following measures during construction of the project.
- **Mufflers.** Construction equipment shall be properly maintained and all internal combustion engine driven machinery with intake and exhaust mufflers and engine shrouds, as applicable, shall be in good condition and appropriate for the equipment. During construction, all equipment, fixed or mobile, shall be operated with closed engine doors and shall be equipped with properly operating and maintained mufflers, consistent with manufacturers' standards.
 - **Electrical Power.** Electrical power, rather than diesel equipment, shall be used to run compressors and similar power tools and to power any temporary structures, such as construction trailers or caretaker facilities.
 - **Equipment Staging.** All stationary equipment shall be staged as far away from noise-sensitive receptors as feasible.
 - **Equipment Idling.** Construction vehicles and equipment shall not be left idling for longer than five minutes when not in use.
 - **Workers' Radios.** All noise from workers' radios shall be controlled to a point that they are not audible at sensitive receptors near construction activity.
 - **Smart Back-up Alarms.** Mobile construction equipment shall have smart back-up alarms that automatically adjust the sound level of the alarm in response to ambient noise levels. Alternatively, back-up alarms shall be disabled and replaced with human spotters to ensure safety when mobile construction equipment is moving in the reverse direction.
 - **Disturbance Coordinator.** The applicant shall designate a disturbance coordinator who shall be responsible for responding to any local complaints about construction noise. The noise disturbance coordinator shall determine the cause of the noise complaint (e.g., starting too early, bad muffler, etc.) and shall require that reasonable measures warranted to correct the problem be implemented. A telephone number for the disturbance coordinator shall be conspicuously posted at the construction site.

With implementation of the above measure, the impact from construction noise would be less than significant.

LESS THAN SIGNIFICANT WITH MITIGATION INCORPORATED

- b. Would the project result in exposure of persons to or generation of excessive groundborne vibration or groundborne noise levels?*

Construction of the project would intermittently generate vibration on and adjacent to the project site. Vibration-generating equipment would include bulldozers and loaded trucks to move materials and debris, caisson drills to install shoring, and vibratory rollers for paving. It is assumed that pile drivers, which generate strong groundborne vibration, would not be used during construction. The distance to the nearest sensitive receptors to the project site, the single-family residences located adjacent to the west and south of the site, is approximately 50 feet. Table 11 identifies vibration

City of Hayward
22626 4th Street Residential Project

velocity levels at a distance of 50 feet from the source and also at 400 feet from the source to show vibration levels that may be experienced at the nearby school.

Table 11 Vibration Levels for Construction Equipment at Noise-Sensitive Receptors

Construction Equipment	Estimated VdB at Nearest Sensitive Receptors (50 feet)	Estimated VdB at Nearby School (400 feet)
Vibratory roller	88	70
Caisson drill	80	62
Large bulldozer	80	62
Loaded trucks	79	61
Small bulldozer	51	33

Vibration levels assume a vibration attenuation rate of 6 dBA per doubling of distance.

Source: FTA 2006

The City has not adopted specific numerical thresholds for groundborne vibration impacts. Therefore, this analysis uses the Federal Transit Administration's (FTA) vibration impact thresholds to determine whether groundborne vibration would be excessive (FTA 2006). The vibration thresholds established by the FTA are 65 VdB for buildings where low ambient vibration is essential for interior operations (such as hospitals and recording studios), 72 VdB for residences and buildings where people normally sleep (including hotels), and 75 VdB for institutional land uses with primary daytime use (such as churches and schools). In terms of groundborne vibration impacts on structures, the FTA states that groundborne vibration levels in excess of 100 VdB could damage fragile buildings and levels in excess of 95 VdB could damage extremely fragile historic buildings.

As shown in Table 11, noise-sensitive receptors would experience the strongest vibration of up to 88 VdB during paving with vibratory rollers and up to 80 VdB during the use of caisson drills and grading activity with large bulldozers. Compliance with Section 4-1.03.4 of the HMC would restrict vibration-generating construction activity to daytime hours that are outside of normal sleeping hours, i.e., 7:00 a.m. to 7:00 p.m. Monday through Saturday and 10:00 a.m. to 6:00 p.m. on Sundays and holidays. While vibration from construction activity could be perceptible at adjacent residences during daytime hours, this timing restriction would ensure that vibration does not exceed the FTA's criterion of 72 VdB during normal sleeping hours at residential uses. In addition, vibration levels would not exceed 75 VdB at the nearby school and would not exceed 95 dBA where damage in buildings could occur. The project will have a less than significant impact from groundborne vibration.

LESS THAN SIGNIFICANT IMPACT

- e. *For a project located in an airport land use plan or, where such a plan has not been adopted, within two miles of a public airport or public use airport, would the project expose people residing or working in the project area to excessive noise levels?*
- f. *For a project within the vicinity of a private airstrip, would the project expose people residing or working in the project area to excessive noise?*

As discussed in Section 8, *Hazards and Hazardous Materials*, the nearest airport to the project site is the Hayward Executive Airport, located approximately 2.6 miles to the southwest. The project site is not located within the Hayward Executive Airport Influence Area and is located outside the existing

noise level contours for the airport (ALUC 2012). The project will not subject workers at the site to excessive noise and there will be no impact.

NO IMPACT

This page intentionally left blank.

13 Population and Housing

	Potentially Significant Impact	Less than Significant with Mitigation Incorporated	Less than Significant Impact	No Impact
--	--------------------------------	--	------------------------------	-----------

Would the project:

a. Induce substantial population growth in an area, either directly (e.g., by proposing new homes and businesses) or indirectly (e.g., through extension of roads or other infrastructure)?	<input type="checkbox"/>	<input type="checkbox"/>	<input checked="" type="checkbox"/>	<input type="checkbox"/>
b. Displace substantial amounts of existing housing, necessitating the construction of replacement housing elsewhere?	<input type="checkbox"/>	<input type="checkbox"/>	<input type="checkbox"/>	<input checked="" type="checkbox"/>
c. Displace substantial numbers of people, necessitating the construction of replacement housing elsewhere?	<input type="checkbox"/>	<input type="checkbox"/>	<input type="checkbox"/>	<input checked="" type="checkbox"/>

a. *Would the project induce substantial population growth in an area, either directly (for example, by proposing new homes and businesses) or indirectly (for example, through extension of roads or other infrastructure)?*

The project would involve the construction of 41 single-family residences and would directly generate population growth in the city. The city currently has a population of 161,040, has 49,665 housing units, and has an average household size of 3.24 persons per household (DOF 2017). The City’s 2040 General Plan would allow up to approximately 7,472 additional single-family dwelling units, 7,339 additional multi-family housing units, and 25,787 additional jobs over 2010 conditions (City of Hayward 2013). Assuming an average household size of 3.24 persons per household, the project would generate approximately 133 new residents in the city (41 households x 3.24 persons per household = 133 new residents). As discussed in Section 10, *Land Use and Planning*, the project is consistent with the General Plan’s LDR and MDR land use designations. The addition of 41 units and 133 residents to the City of Hayward would be within the growth envisioned under the City’s General Plan and would not be considered substantial population growth. Impacts will be less than significant.

LESS THAN SIGNIFICANT IMPACT

- b. *Would the project displace substantial numbers of existing housing, necessitating the construction of replacement housing elsewhere?*
- c. *Would the project displace substantial numbers of people, necessitating the construction of replacement housing elsewhere?*

The project site is currently vacant. No existing residences would need to be demolished or existing residents displaced due to the development of the project. No impact will occur.

NO IMPACT

This page intentionally left blank.

14 Public Services

	Potentially Significant Impact	Less than Significant with Mitigation Incorporated	Less than Significant Impact	No Impact
--	--------------------------------	--	------------------------------	-----------

a. Would the project result in substantial adverse physical impacts associated with the provision of new or physically altered governmental facilities, or the need for new or physically altered governmental facilities, the construction of which could cause significant environmental impacts, in order to maintain acceptable service ratios, response times or other performance objectives for any of the public services:

1	Fire protection?	<input type="checkbox"/>	<input type="checkbox"/>	<input checked="" type="checkbox"/>	<input type="checkbox"/>
2	Police protection?	<input type="checkbox"/>	<input type="checkbox"/>	<input checked="" type="checkbox"/>	<input type="checkbox"/>
3	Schools?	<input type="checkbox"/>	<input type="checkbox"/>	<input checked="" type="checkbox"/>	<input type="checkbox"/>
4	Parks?	<input type="checkbox"/>	<input type="checkbox"/>	<input checked="" type="checkbox"/>	<input type="checkbox"/>
5	Other public facilities?	<input type="checkbox"/>	<input type="checkbox"/>	<input checked="" type="checkbox"/>	<input type="checkbox"/>

a.1. Would the project result in substantial adverse physical impacts associated with the provision of new or physically altered fire protection facilities, or the need for new or physically altered governmental facilities, the construction of which could cause significant environmental impacts, in order to maintain acceptable service ratios, response times or other performance objectives?

Fire protection is provided to the City by the Hayward Fire Department (HFD). The HFD provides fire suppression, advanced life support/emergency medical, emergency services, and public education. HFD has nine fire districts and stations. The project site is in District 1 and is served by Fire Station 1 located at 22700 Main Street, approximately 0.6 mile, or four minutes driving time, from the project site (HFD 2018). Hayward adopted the 2015 edition of the International Fire Code and the 2016 California Fire Code as the City’s Fire Code in 2017 (HMC Section 3-14.00).

The proposed project involves the development of 41 residential units on an undeveloped site surrounded by residential and commercial development. Therefore, the proposed project would incrementally increase the demand for fire and medical services. The proposed project would be required to comply with City requirements for fire access and on-site fire prevention facilities (e.g., fire hydrants and sprinkler systems). The project involves residential development on a site that is planned for residences and surrounded by residential development currently served by the HFD. As described under Section 10, *Land Use and Planning*, and Section 13, *Population and Housing*, the project is consistent with the General Plan’s LDR and MDR land use designations and would not

City of Hayward
22626 4th Street Residential Project

generate growth beyond that anticipated in the General Plan. Therefore, the proposed project would not place an unanticipated burden on fire protection services or affect response times or service ratios such that new or expanded fire facilities would be needed. Impacts will be less than significant.

LESS THAN SIGNIFICANT IMPACT

a.2. Would the project result in substantial adverse physical impacts associated with the provision of new or physically altered police protection facilities, or the need for new or physically altered police protection facilities, the construction of which could cause significant environmental impacts, in order to maintain acceptable service ratios, response times or other performance objectives?

The Hayward Police Department (HPD) provides law enforcement services in Hayward. The nearest police station to the site is located at 300 West Winton Avenue, approximately two miles southwest of the project site (approximately ten minutes driving time). The project would involve the construction of 41 single-family residences on a site surrounded by existing development and currently served by the HPD. Although the project would incrementally increase the demand for police services, the project site is located in the close vicinity (within two miles) of the City's police headquarters and was envisioned for future residential development in the City's General Plan. As such, the proposed project would not require the construction or expansion of police protection facilities beyond those already planned under General Plan assumptions. Impacts will be less than significant.

LESS THAN SIGNIFICANT IMPACT

a.3. Would the project result in substantial adverse physical impacts associated with the provision of new or physically altered schools, or the need for new or physically altered schools, the construction of which could cause significant environmental impacts, in order to maintain acceptable service ratios, response times or other performance objectives?

The project site is served by the Hayward Unified School District (HUSD). The project would involve the construction of 41 single-family residences. Assuming a conservative student generation rate of one student per residence, the proposed project would increase the number of students attending schools operated by HUSD by approximately 41 additional students. The addition of 41 students to the HUSD would not result in the need for additional school facilities. In addition, pursuant to Senate Bill 50 (Section 65995[h]), payment of mandatory fees to the affected school district would reduce potential school impacts to less than significant level under CEQA. Therefore, the project will have a less than significant impact with respect to schools.

LESS THAN SIGNIFICANT IMPACT

a.4. Would the project result in substantial adverse physical impacts associated with the provision of new or physically altered parks, or the need for new or physically altered parks, the construction of which could cause significant environmental impacts, in order to maintain acceptable service ratios or other performance objectives?

The Hayward Area Recreation and Park District (H.A.R.D.) is an independent special-use district created to provide park and recreational services for over 280,000 residents in Hayward, Castro Valley, and unincorporated areas of Alameda County (H.A.R.D 2018). Parks in the vicinity of the project site include the Hayward Japanese Gardens (approximately 0.5 mile northwest of the site),

the Sulphur Creek Nature Center (approximately 0.8 mile southeast of the site), and the San Filipe Community Center Park (approximately one mile east of the site). Future residents would be likely to use these parks as well as others in the city and region. However, the addition of 133 new residents (see Section 13, *Population and Housing*) would not increase the use of parks such that substantial physical deterioration of the facility would be accelerated. The project itself includes both private open space for each residence and shared open space areas that would partially offset use of local and regional parks and recreational facilities. In addition, pursuant to City Code (Chapter 10.16), the project would be required to pay mandatory park in-lieu fees, which helps fund maintenance and upkeep of area parks. Therefore, the project will not result in the need for new or physically altered parks, the construction of which would cause significant environmental impacts.

LESS THAN SIGNIFICANT IMPACT

a.5. Would the project result in substantial adverse physical impacts associated with the provision of new or physically altered governmental facilities, or the need for new or physically altered governmental facilities, the construction of which could cause significant environmental impacts, in order to maintain acceptable service ratios, response times or other performance objectives for other public facilities?

As discussed in Section 13, *Population and Housing*, the project would not add substantial population to Hayward and is consistent with growth anticipated in the City's General Plan. The project involves infill development and the addition of 41 single-family homes would not result in a material effect on the need for additional public facilities. Therefore, the project would not substantially increase demand for public facilities and resources. Impacts to stormwater, wastewater, and water facilities are discussed in Section 18, *Utilities and Service Systems*. Impacts will be less than significant.

LESS THAN SIGNIFICANT IMPACT

This page intentionally left blank.

15 Recreation

	Potentially Significant Impact	Less than Significant with Mitigation Incorporated	Less than Significant Impact	No Impact
a. Would the project increase the use of existing neighborhood and regional parks or other recreational facilities such that substantial physical deterioration of the facility would occur or be accelerated?	<input type="checkbox"/>	<input type="checkbox"/>	<input checked="" type="checkbox"/>	<input type="checkbox"/>
b. Does the project include recreational facilities or require the construction or expansion of recreational facilities which might have an adverse physical effect on the environment?	<input type="checkbox"/>	<input type="checkbox"/>	<input checked="" type="checkbox"/>	<input type="checkbox"/>

a. *Would the project increase the use of existing neighborhood and regional parks or other recreational facilities such that substantial physical deterioration of the facility would occur or be accelerated?*

The addition of an estimated 133 new residents to the city population with the proposed project (refer to Section 13, *Population and Housing*) would increase demand for parks and recreational facilities. Parks and recreational facilities in the vicinity of the project site include the Hayward Japanese Gardens (approximately 0.5 mile northwest of the site), the Sulphur Creek Nature Center (approximately 0.8 mile southeast of the site), and the San Filipe Community Center Park (approximately one mile east of the site). Future residents would be likely to use these parks and recreational facilities as well as others in the city and region. However, the addition of 133 new residents would not increase the use of local and regional parks and recreational facilities such that substantial physical deterioration of the facility would be accelerated. The project itself includes both private open space for each residence and shared open space areas that would partially offset use of local and regional parks and recreational facilities. In addition, pursuant to City Code (Chapter 10.16), the project would be required to pay mandatory park in-lieu fees, which helps fund maintenance and upkeep of area parks and recreational facilities. Payment of these fees will reduce potential impacts on park and recreational facilities to a less than significant level.

LESS THAN SIGNIFICANT IMPACT

b. *Does the project include recreational facilities or require the construction or expansion of recreational facilities which might have an adverse physical effect on the environment?*

The project would include both private open space for each residence and shared open space in the form of a trail system, which would be located on the project’s 4th Street frontage and also in an open area near the northwestern corner of the project site along 4th Street. The amount of private open space for each residence would range from 100 to 2,168 square feet. The common open space areas are not specifically a recreational use but may be used for recreational purposes by the future residents. The impacts associated with development of these open space areas are discussed throughout this document as part of the analysis of project construction as a whole and would not

City of Hayward
22626 4th Street Residential Project

create any physical adverse effects on the environment. As discussed above under question (a), the project will not substantially increase demand for parks or recreational facilities.

LESS THAN SIGNIFICANT IMPACT

16 Transportation/Traffic

	Potentially Significant Impact	Less than Significant with Mitigation Incorporated	Less than Significant Impact	No Impact
--	--------------------------------	--	------------------------------	-----------

Would the project:

a. Conflict with an applicable plan, ordinance or policy establishing measures of effectiveness for the performance of the circulation system, taking into account all modes of transportation, including mass transit and non-motorized travel and relevant components of the circulation system, including but not limited to intersections, streets, highways, and freeways, pedestrian and bicycle paths, and mass transit?	<input type="checkbox"/>	<input type="checkbox"/>	<input checked="" type="checkbox"/>	<input type="checkbox"/>
b. Conflict with an applicable congestion management program, including, but not limited to level of service standards and travel demand measures, or other standards established by the county congestion management agency for designated roads or highways?	<input type="checkbox"/>	<input type="checkbox"/>	<input checked="" type="checkbox"/>	<input type="checkbox"/>
c. Result in a change in air traffic patterns, including either an increase in traffic levels or a change in location that results in substantial safety risks?	<input type="checkbox"/>	<input type="checkbox"/>	<input type="checkbox"/>	<input checked="" type="checkbox"/>
d. Substantially increase hazards due to a design feature (e.g., sharp curves or dangerous intersections) or incompatible use (e.g., farm equipment)?	<input type="checkbox"/>	<input checked="" type="checkbox"/>	<input type="checkbox"/>	<input type="checkbox"/>
e. Result in inadequate emergency access?	<input type="checkbox"/>	<input type="checkbox"/>	<input type="checkbox"/>	<input checked="" type="checkbox"/>
f. Conflict with adopted policies, plans, or programs regarding public transit, bicycle, or pedestrian facilities, or otherwise substantially decrease the performance or safety of such facilities?	<input type="checkbox"/>	<input checked="" type="checkbox"/>	<input type="checkbox"/>	<input type="checkbox"/>

Existing Setting

Methodology

This analysis is based on the transportation assessment prepared for the proposed project by Kittelson & Associates in April 2018. The assessment is included as Appendix D of this Initial Study.

The intersections of 4th Street and A Street, 4th Street and B Street, and 4th Street and C Street were analyzed using Synchro intersection analysis software to determine the impact of the Project on intersection operations, including level of service and delay. The intersections were assessed using the Highway Capacity (HCM) 2010 methodology. The HCM 2010 methodology assigns a level of service (LOS) grade (from A to F) to an intersection based on the average control delay for vehicles at the intersection. Based on the latest City General Plan and Traffic Impact Study Guidelines, LOS E is the minimum acceptable level of service for intersections in Hayward. LOS grades and corresponding delay values under the HCM 2010 methodology are provided in Table 12.

Table 12 Intersection Level of Service and Delay Thresholds

LOS	Average Control Delay Per Vehicle (Seconds)	
	Signalized	Unsignalized
A	<10.0	<10.0
B	>10.0 and <20.0	>10.0 and <15.0
C	>20.0 and <35.0	>15.0 and <25.0
D	>35.0 and <55.0	>25.0 and <35.0
E	>55.0 and <80.0	>35.0 and <50.0
F	>80.0	>50.0

Source: Kittelson & Associates 2018, Appendix D

The all-way stop-controlled intersection of 4th Street and C Street was also examined to see if volumes triggered a traffic signal warrant or pedestrian signal warrant.

In addition, ninety-fifth percentile queue lengths for movements with turn pockets at the three study intersections were assessed. These ninety-fifth percentile queue lengths determine the theoretical “maximum” queue.

Existing Conditions

To assess the existing traffic volumes on study area intersections, turning movement counts were collected on Tuesday, January 23, 2018, which represents a typical weekday. Conditions on that day were clear without any extreme weather and all schools were in session. Turning movement counts were collected during the AM peak period (7:00 a.m. to 9:00 p.m.) and PM peak period (4:00 p.m. to 6:00 p.m.). The AM and PM peak hour volumes, lane configurations, and intersection controls are shown on Figure 3 of the traffic study.

Existing LOS for the study intersections is shown in Table 13. As shown in the table, all intersections operate acceptably (LOS E or better) in the AM and PM peak hours.

Table 13 Level of Service – Existing Conditions

No.	Intersection	Control	Peak Hour	Delay	LOS
1.	4th Street and A Street	Signal	AM	19.5	B
			PM	23.8	C
2.	4th Street and B Street	Signal	AM	12.3	B
			PM	8.9	A
3.	4th Street and C Street	All-Way Stop Control	AM	12.9	B
			PM	11.6	B

Source: Kittelson & Associates 2018, Appendix D

Traffic signal and pedestrian signal warrants for the intersection of 4th Street and C Street are shown in Table 14. Vehicular and pedestrian volumes at this all-way stop-controlled intersection under existing conditions do not trigger a traffic signal warrant or pedestrian signal warrant in either peak hour.

Table 14 Intersection Traffic Warrants – Existing Conditions

No.	Intersection	Control	Peak Hour	Traffic Signal Warrant	Pedestrian Signal Warrant
3.	4th Street and C Street	All-Way Stop Control	AM	No	No
			PM	No	No

Source: Kittelson & Associates 2018, Appendix D

The 95th percentile queue lengths for turning movements with turn pockets at the three study intersections are shown in Table 15. As shown in the table, the queue lengths do not exceed turn pocket storage lengths at any locations except for one under existing conditions. The AM and PM peak hour queues for westbound left turning vehicles at the intersection of 4th Street and A Street exceed the turn pocket storage length.

Table 15 Queuing – Existing Conditions

No.	Intersection	Movement	Pocket Length (feet)	Peak Hour	Queue (feet)
1.	4th Street and A Street	Northbound Right	95	AM	62
				PM	59
		Eastbound Left	70	AM	<25
				PM	25
		Westbound Left	110	AM	273
				PM	212
2.	4th Street and B Street	Southbound Left	105	AM	63
				PM	56
		Eastbound Left	130	AM	<25
				PM	28
3.	4th Street and C Street	Northbound Right	35	AM	<25
				PM	<25

Source: Kittelson & Associates 2018, Appendix D

City of Hayward
22626 4th Street Residential Project

Trip Generation, Distribution, and Assignment

The number of vehicle trips expected to be generated by the project were estimated using rates published in the Institute of Transportation Engineers (ITE) *Trip Generation Manual 10th Edition*. The resulting trip generation estimates are shown in Table 16. As shown in the table, the project is estimated to generate 458 daily trips, including 34 trips during the AM peak hour (9 inbound and 25 outbound) and 43 trips in the PM peak hour (27 inbound and 16 outbound).

Table 16 Proposed Project Trip Generation

Land Use	Dwelling Units	Daily Trips	AM Peak Hour Trips			PM Peak Hour Trips		
			In	Out	Total	In	Out	Total
Single-Family Homes ¹	41	458 ¹	9	25	34 ²	27	16	43 ³

Notes:

¹ Daily trip generation for Single-Family Detached Housing (ITE Code 210) is calculated using the equation $\ln(T)=0.92*\ln(X)+2.71$

² AM peak hour trip generation for Single-Family Detached Housing (ITE Code 210) is calculated using the equation $T=0.71(X)+4.80$

³ PM peak hour trip generation for Single-Family Detached Housing (ITE Code 210) is calculated using the equation $\ln(T)=0.96*\ln(X)+0.20$

Source: ITE Trip Generation Manual, 10th Edition; Kittelson and Associates 2018 (Appendix D)

The trip distribution for the Project was developed using the City of Hayward General Plan travel demand model. The Project trip distribution is based on the model's distribution of trips in and out of the traffic analysis zone (TAZ 655) representing the project site. The trip distribution for the project is as follows and is displayed on Figure 4 of the traffic assessment in Appendix D:

- 18 percent to/from the northwest along A Street
- 8 percent to/from the northeast along A Street
- 25 percent to/from the west along B Street
- 20 percent to/from the east along B Street
- 4 percent to/from the southwest along C Street
- 1 percent to/from the southeast along C Street
- 24 percent to/from the south along 4th Street

The trip distribution was applied to the project trip generation. The resulting project-only trips at the study intersections are presented on Figure 5 of the traffic assessment in Appendix D. In addition, project-only trips at the project driveways and at the intersection of B Street and Chestnut Street are shown on Figure 6 of the traffic assessment in Appendix D.

Impact Analysis

- a. *Would the project conflict with an applicable plan, ordinance or policy establishing a measure of effectiveness for the performance of the circulation system, taking into account all modes of transportation, including mass transit and non-motorized travel and relevant components of the circulation system, including but not limited to intersections, streets, highways, and freeways, pedestrian and bicycle paths, and mass transit?*

Existing plus Project Level of Service

Traffic operations were evaluated at the study intersections under existing plus project conditions and traffic generated by the project. Existing Plus Project LOS for the study intersections is shown in Table 17. As shown in the table, all intersections are forecast to operate acceptably (LOS E or better) in the AM and PM peak hours when accounting for project trips. Given that all intersections operate acceptably in the Existing Plus Project scenario, the project would not result in a significant impact. Average delay increases very slightly with the addition of project trips (0.2 to 0.5 second); this represents an increase of less than four percent.

Table 17 Existing plus Project Conditions Intersection Level of Service

No.	Intersection	Control	Peak Hour	Existing Conditions		Existing Plus Project Conditions		Change in Delay ² (Sec)	Significant Impact?
				Delay	LOS	Delay	LOS		
1.	4th Street and A Street	Signal	AM	19.5	B	19.7	B	+0.2	No
			PM	23.8	C	24.2	C	+0.4	No
2.	4th Street and B Street	Signal	AM	12.3	B	12.8	B	+0.5	No
			PM	8.9	A	9.2	A	+0.3	No
3.	4th Street and C Street	All-Way Stop Control	AM	12.9	B	13.1	B	+0.2	No
			PM	11.6	B	11.8	B	+0.2	No

Source: Kittelson & Associates 2018, Appendix D

Existing Plus Project Traffic Warrants

Traffic signal and pedestrian signal warrants for the intersection of 4th Street & C Street are shown in Table 18. As shown in the table, the project would not trigger a traffic signal warrant or pedestrian signal warrant in either peak hour.

Table 18 Intersection Traffic Warrants – Existing Plus Project Conditions

No.	Intersection	Control	Peak Hour	Traffic Signal Warrant	Pedestrian Signal Warrant
3.	4th Street and C Street	All-Way Stop Control	AM	No	No
			PM	No	No

Source: Kittelson & Associates 2018, Appendix D

Existing Plus Project Queuing

The ninety-fifth percentile queue lengths (when accounting for project trips) at the study intersections are shown in Table 19. As shown in the table, the AM and PM peak hour queues for westbound left turning vehicles at the intersection of 4th Street and A Street already exceed the storage length without the proposed project. This roadway segment is outside the boundaries of the City of Hayward and is within Alameda County's unincorporated Castro Valley community. With the project, the westbound queue length would increase by approximately one foot. This increase is not significant. The project would not cause queues lengths to exceed available storage at the other study intersections. Overall, queuing impacts would be less than significant.

City of Hayward
22626 4th Street Residential Project

Table 19 Queuing – Existing Plus Project Conditions

No.	Intersection	Movement	Pocket Length (feet)	Peak Hour	No Project Queue (feet)	Plus Project Queue (feet)	Change (feet)
1.	4th Street and A Street	Northbound Right	95	AM	62	63	+1
				PM	59	60	+1
		Eastbound Left	70	AM	<25	<25	0
				PM	25	25	0
		Westbound Left	110	AM	273	274	+1
				PM	212	213	+1
2.	4th Street and B Street	Southbound Left	105	AM	63	66	+3
				PM	56	61	+5
		Eastbound Left	130	AM	<25	<25	0
				PM	28	28	0
		Northbound Right	35	AM	<25	<25	0
				PM	<25	<25	0
3.	4th Street and C Street	Northbound Right	35	AM	<25	<25	0
				PM	<25	<25	0

Source: Kittelson & Associates 2018, Appendix D

LESS THAN SIGNIFICANT IMPACT

- b. *Would the project conflict with an applicable congestion management program, including, but not limited to level of service standards and travel demand measures, or other standards established by the county congestion management agency for designated roads or highways?*

According to the Alameda County Congestion Management Program (CMP), the LOS standard for Metropolitan Transportation System (MTS) roadways, which include the CMP roadway network, is LOS E, except for those locations at LOS F in 1991. Significant traffic impacts on MTS roadways in the study area are identified if the project causes either the operations on MTS roadways to deteriorate from LOS E or better to LOS F or an increase volume-to-capacity (v/c) ratio on an MTS roadway already operating at LOS F by more than three percent. The only Tier 1⁵ MTS roadway in the vicinity of the project site is A Street north of the project site (Alameda County Transportation Commission [CTC] 2017). A Street, B Street, and C Street in the vicinity of the project site are all considered Tier 2⁶ roadways.

As discussed in the response to question (a) above, all the intersections evaluated in the traffic assessment would operate at acceptable levels of service (LOS E and better) in the existing and cumulative plus project scenarios during both AM and PM peak hours. Therefore, the project would not conflict with any Alameda County CMP impact criteria. This impact will be less than significant.

LESS THAN SIGNIFICANT IMPACT

⁵ Tier 1 indicates roadway that was in the original adopted CMP network when it was established in 1991 (Alameda CTC 2017).

⁶ Tier 2 consists of an expanded number of roadways identified using a set of adopted criteria that reflects the countywide significance. This Tier 2 network forms a supplemental network that Alameda CTC monitors for informational purposes only and is not used in the conformity findings process (Alameda CTC 2017).

- c. *Would the project result in a change in air traffic patterns, including either an increase in traffic levels or a change in location that results in substantial safety risks?*

The nearest airport to the project site is the Hayward Executive Airport, located approximately 2.6 miles to the southwest. The project site is not located within the Hayward Executive Airport Influence Area and is located outside the existing noise level contours for the airport (ALUC 2012). In addition, the project would involve the construction of 41 two-story single-family residences in an area with structures of similar size and scale. Therefore, the project will have no impact on air traffic.

NO IMPACT

- d. *Would the project substantially increase hazards due to a design feature (e.g., sharp curves or dangerous intersections) or incompatible use (e.g., farm equipment)?*

The project involves residential development in a neighborhood that includes residential and commercial uses. The project would not introduce an incompatible use that would substantially introduce hazards such as atypical vehicles or vehicle use.

Inadequate site access may result in operational traffic safety hazards. The following vehicular site access analysis is based on information provided in the transportation impact memorandum prepared by Kittelson & Associates (2018, see Appendix D). Potential operational safety hazards related to pedestrian, bicycle, and transit access and facilities are discussed in the response to question (f).

Vehicles accessing the project site would utilize 4th Street and Chestnut Street, which are accessible from A Street, B Street, and C Street in the study area. Near the project site, 4th Street, B Street, and C Street provide one travel lane in each direction and A Street provides two travel lanes in each direction.

There are two access points proposed for the southern portion of the project site from B Street. The western driveway is located approximately 130 feet east of 4th Street and the eastern driveway is located approximately 270 feet east of 4th Street. Both driveways are proposed to be full-access, unsignalized, and stop-controlled for vehicles exiting the driveways.

There are two access points proposed for the northern portion of the project site: one driveway on B Street and one access point from Chestnut Street. The B Street driveway is located approximately 120 feet east of 4th Street and is proposed to be full-access, unsignalized, and stop-controlled for vehicles exiting the driveways. Vehicles traveling to and from the Chestnut Street driveway would access the project through the intersection of B Street and Chestnut Street, which is a side-street stop-controlled intersection located approximately 410 feet east of 4th Street.

Vehicles using the project driveways may conflict with westbound queues at the intersection of 4th Street and B Street, which provides a single shared westbound left-through-right lane. This is a potential issue for the following driveway movements:

- Left-turning or right-turning vehicles exiting the northern project driveways onto B Street
- Left-turning vehicles exiting the southern project driveways onto B Street
- Left-turning vehicles entering any of the project driveways from B Street

The 95th percentile westbound queue lengths at the intersection of 4th and B are shown in Table 20. As shown in the table, westbound queue lengths are forecast to exceed the distance between the intersection and the proposed driveways to the southern portion of the site (which are 130 feet

City of Hayward
22626 4th Street Residential Project

and 270 feet from the intersection) during both peak hours. In addition, the queue length is forecast to exceed the distance between the intersection and the driveway to the northern portion of the project site (which is 120 feet from the intersection) during both peak hours. Further, vehicles using the Chestnut Street northern driveway to access the northern portion of the site may face excessive queues during the AM peak hour.

Table 20 Westbound Queuing – 4th Street and B Street

Intersection	Movement	Peak Hour	No Project Queue (feet)	Plus Project Queue (feet)
4th Street and B Street	Westbound Left/Through/Right	AM	510	534*
		PM	262	274

Asterisk (*) denotes that 95th percentile volume exceeds capacity, queue may be longer.

Source: Kittelson & Associates 2018, Appendix D

In order to facilitate vehicles entering and exiting the project driveways and reduce the potential for traffic hazards, Mitigation Measure T-1 is required.

Mitigation Measure

The following mitigation measure would reduce impacts regarding traffic hazards for vehicles entering and exiting project driveways.

T-1 B Street Roadway Striping and Signage. Prior to issuance of a certificate of occupancy, the project applicant shall install cautionary signage warning of the new driveway locations on B Street approaching the project site. In addition, the project applicant shall fund roadway striping along the project's B Street frontage that shall display a prohibition against vehicles blocking access to the project driveways (Keep Clear) when waiting at a red light.

With implementation of Mitigation Measure T-1, impacts related to hazards at project driveways will be less than significant.

LESS THAN SIGNIFICANT WITH MITIGATION INCORPORATED

e. Would the project result in inadequate emergency access?

The project site is directly accessible via driveways on B Street and Chestnut Street. The project would be required to comply with all building, fire, and safety codes and specific development plans would be subject to review and approval by the City's Public Works Department and HFD. Required review by these departments would ensure the circulation system for the project site would provide adequate emergency access. In addition, the project would not require temporary or permanent closures to roadways. There will be no impact.

NO IMPACT

f. Would the project conflict with adopted policies, plans, or programs regarding public transit, bicycle, or pedestrian facilities, or otherwise substantially decrease the performance or safety of such facilities?

The following is based on the transportation impact memorandum prepared by Kittelson & Associates (2018, Appendix D).

Bicycle Facilities

Currently, bicyclists accessing the project site utilize a Class III bike route along 4th Street and on A Street west of the project site (Figure 8 in the transportation assessment in Appendix D). Bicycle lanes on A Street provide access between the project site and Castro Valley. The bicycle lanes start outside the City of Hayward limits, approximately 95 feet east of the intersection of 4th Street and A Street. Bicycle access points at the project site would include the driveways (along B Street and Chestnut Street) and the project frontage along 4th Street and B Street.

Existing bicycle volumes at three study intersections along 4th Street are shown in Table 21. Low levels of bicycle activity were observed during the weekday AM peak hour. Greater numbers of bicyclists passed through the intersections during the PM peak hour. Nonetheless, the addition of project-related bicycle trips would not decrease the performance of bicycle lanes and facilities.

Table 21 Existing Bicycle Counts

No.	Intersection	AM Peak Hour	PM Peak Hour
1.	4th Street and A Street	3	16
2.	4th Street and B Street	6	14
3.	4th Street and C Street	1	10

Source: Kittelson & Associates 2018

The project driveways present a potential conflict between bicyclists and vehicles. Vehicles entering or exiting the project driveways could potentially cross the path of a bicyclist traveling on B Street. The potential for conflict would be reduced with implementation of Mitigation Measure T-2 described at the end of this section.

Pedestrian Facilities

Currently, sidewalks are provided along most roadways in the area. When present, sidewalks are generally in good condition and free of cracks. Several sidewalk gaps exist along 4th Street, including:

- Between A Street and B Street – Entire east side
- Between A Street and B Street – Portion of west side
- Between B Street and C Street – Upper half of west side
- Between B Street and C Street – Most of east side

The sidewalks on 4th Street between B Street and C Street do not have raised curbs; therefore, vehicles may park on sidewalks. The two signalized intersections of 4th Street and A Street and 4th Street and B Street do not provide crosswalks on their eastern legs. Crossing these legs is prohibited with signage and neither curb ramps nor pedestrian signal heads are provided. Pedestrian countdown signals are available on three legs at 4th Street and B Street and on the southern leg at 4th Street and A Street. In addition, marked crosswalks are not provided on the northern and eastern legs of 4th Street and C Street.

To facilitate pedestrian access, the proposed project includes the installation and improvement of sidewalks along the project frontage, including filling in sidewalk gaps along 4th Street adjacent to the project. Therefore, the project would improve pedestrian access to the project site compared to

City of Hayward
22626 4th Street Residential Project

existing conditions. Pedestrian access points to the project would include the sidewalk-adjacent frontage as well as the project driveways.

However, the project driveways present a potential conflict between pedestrians and vehicles that parallel potential issues between bicyclists and vehicles at the driveways. Vehicles entering or exiting the project driveways could cross the path of a pedestrian crossing the driveway. The potential for conflict would be reduced with implementation of Mitigation Measure T-2 described at the end of this section.

In addition, currently, there is no marked pedestrian crosswalk on the eastern leg of the intersection of 4th Street and B Street. Pedestrians that wish to cross the eastern leg of the intersection must cross the intersection's three other legs or illegally cross, which presents a safety hazard. Installing facilities on the eastern leg would facilitate pedestrian travel between project residents and local destinations, including access to bus stops (discussed further below). Therefore, Mitigation Measure T-3 is required to reduce this potential safety hazard for pedestrians generated by the proposed project.

Transit Service

Transit service to the project site is provided by the Alameda-Contra Costa Transit District (AC Transit). Bus service on B Street consists of AC Transit Route 32, which connects to the Hayward BART Station to the west and other destinations such as Bay Fair BART and Castro Valley BART. AC Route 32 runs seven days a week with 60-minute headways. As part of its AC Go project, AC Transit will renumber this route to Route 28 and double weekday service to 30-minute headways. Implementation of this change is scheduled for June 2018.

There are four AC Route 32 bus stops in the project site vicinity. All four of these stops are marked by a pole and sign and lack bus stop amenities such as a bench or shelter. Bus stops in the vicinity of the site include the following:

- Stop #51534 located at the northwest corner of 4th Street and B Street, directly to the west of the project site
- Stop #59878 located at the southeast corner of 4th Street and B Street, directly between the project site's northern and southern portions.
- Stop #58230 located at the southwest corner of 5th Street and B Street, directly to the east of the project site.
- Stop #58920 located at the northeast corner of 5th Street and B Street, directly to the east of the project site.

The proposed project may increase transit use, but would not increase ridership or area traffic such that transit performance would be substantially reduced.

Pedestrian movement between the project and these stops consists of sidewalks along both sides of B Street. However, future project residents wishing to walk between the project's northern portion and the eastbound Route 32 bus stop closest to the project (stop #59878 at the southeast corner of 4th Street and B Street) must cross three intersection legs or unsafely cross B Street since the intersection does not provide a crosswalk, curb ramps, or pedestrian signal head on its eastern leg. Mitigation Measure T-3 is required to install a crosswalk at this location such that the safety hazard for pedestrians from the northern portion of the site wishing to access the transit stop are reduced.

In addition, the location of stop #59878 at the southeast corner of 4th Street and B Street relative to the project's southwestern driveway presents a potential conflict between transit vehicles, transit users, and automobiles entering the project's southern portion. Given the bus stop's location directly to the left of the driveway, eastbound vehicles making a right turn from B Street into the driveway may not see pedestrians crossing the driveway to and from a stopped bus. Therefore, Mitigation Measure T-4 is required to reduce potential safety hazards.

Mitigation Measure

The following mitigation measure would reduce impacts related to potential conflicts between pedestrians and bicyclists on B Street and vehicles entering and exiting the project's 4th Street driveways.

- T-2 Driveway Signage.** The project applicant shall install caution signage, stop bars, and marked crosswalks at the project driveways on B Street to ensure that vehicles stop before exiting the driveways and entering B Street.
- T-3 4th and B Street Pedestrian Improvements.** The project applicant shall coordinate with City of Hayward Transportation Department staff to design and fund installation of a marked crosswalk, pedestrian bulbouts, curb ramps, and a pedestrian countdown signal on the eastern leg of 4th Street and B Street. This includes expanding the traffic signal hardware to add a pedestrian phase, a pedestrian signal head, and a pedestrian push button.
- T-4 Bus Bulbout.** The project applicant shall coordinate with the City of Hayward and AC Transit to install a bus bulbout at the bus stop along the project site's B Street frontage at the southern quadrant of 4th Street and B Street. The applicant shall also install signage warning pedestrians of entering and exiting vehicles at the project driveways.

With implementation of mitigation measures T-2, T-3, and T-4, impacts related to the safety of pedestrian, bicycle, and transit facilities and operations will be less than significant.

LESS THAN SIGNIFICANT WITH MITIGATION INCORPORATED

This page intentionally left blank.

17 Tribal Cultural Resources

	Potentially Significant Impact	Less than Significant with Mitigation Incorporated	Less than Significant Impact	No Impact
<p>Would the project cause a substantial adverse change in the significance of a tribal cultural resource, defined in a Public Resources Code section 21074 as either a site, feature, place, cultural landscape that is geographically defined in terms of the size and scope of the landscape, sacred place, or object with cultural value to a California Native American tribe, and that is:</p>				
<p>a. Listed or eligible for listing in the California Register of Historical Resources, or in a local register of historical resources as defined in Public Resources Code section 5020.1(k), or</p>	<input type="checkbox"/>	<input checked="" type="checkbox"/>	<input type="checkbox"/>	<input type="checkbox"/>
<p>b. A resource determined by the lead agency, in its discretion and supported by substantial evidence, to be significant pursuant to criteria set forth in subdivision (c) of Public Resources Code Section 2024.1. In applying the criteria set forth in subdivision (c) of Public Resources Code Section 5024.1, the lead agency shall consider the significance of the resource to a California Native American tribe.</p>	<input type="checkbox"/>	<input checked="" type="checkbox"/>	<input type="checkbox"/>	<input type="checkbox"/>

Setting

As of July 1, 2015, California Assembly Bill 52 of 2014 (AB 52) was enacted and expands CEQA by defining a new resource category, "tribal cultural resources." AB 52 establishes that "A project with an effect that may cause a substantial adverse change in the significance of a tribal cultural resource is a project that may have a significant effect on the environment" (PRC Section 21084.2). It further states that the lead agency shall establish measures to avoid impacts that would alter the significant characteristics of a tribal cultural resource, when feasible (PRC Section 21084.3).

PRC Section 21074 (a)(1)(A) and (B) defines tribal cultural resources as "sites, features, places, cultural landscapes, sacred places, and objects with cultural value to a California Native American tribe" and is as follows:

1. Listed or eligible for listing in the CRHR, or in a local register of historical resources as defined in Public Resources Code section 5020.1(k), or
2. A resource determined by the lead agency, in its discretion and supported by substantial evidence, to be significant pursuant to criteria set forth in subdivision (c) of Public Resources Code Section 5024.1. In applying these criteria, the lead agency shall consider the significance of the resource to a California Native American tribe.

City of Hayward
22626 4th Street Residential Project

AB 52 also establishes a formal consultation process for California tribes regarding those resources. The consultation process must be completed before a CEQA document can be certified. Under AB 52, lead agencies are required to “begin consultation with a California Native American tribe that is traditionally and culturally affiliated with the geographic area of the proposed project.” Native American tribes to be included in the process are those that have requested notice of projects proposed within the jurisdiction of the lead agency.

One tribe, the Lone Band of Miwok Indians, has requested to be notified of projects proposed in the City of Hayward. The City of Hayward prepared and mailed an AB 52 notification letter to this tribe on January 10, 2018. On March 16, 2018, the City held a consultation meeting with the Lone Band of Miwok Indians and Rincon Consultants to discuss the project and potential tribal cultural resources. The Tribe identified the project site as highly sensitive for archaeological resources because of its proximity to the adjacent creek and the proximity of village sites. The tribe did not identify specific tribal cultural resources within the project site.

Impact Analysis

- a. *Would the project cause a substantial adverse change in the significance of a tribal cultural resource as defined in Public Resources Code 21074 that is listed or eligible for listing in the California Register of Historical Resources, or in a local register of historical resources as defined in Public Resources Code section 5020.1(k)?*
- b. *Would the project cause a substantial adverse change in the significance of a tribal cultural resource as defined in Public Resources Code 21074 that is a resource determined by the lead agency, in its discretion and supported by substantial evidence, to be significant pursuant to criteria set forth in subdivision (c) of Public Resources Code Section 2024.1?*

The AB 52 consultation process and SLF (discussed under Section 5, *Cultural Resources*) did not identify specific tribal cultural resources within the project site. However, the project site and vicinity have been identified as sensitive for potential resources by the Lone Band of Miwok Indians. The proposed excavation of the project site could potentially result in adverse effects on unanticipated tribal cultural resources. However, impacts from the unanticipated discovery of tribal cultural resources during construction would be less than significant with Mitigation Measures CUL-1 through CUL-2 identified in Section 5, *Cultural Resources*, and with Mitigation Measure TCR-1 below.

Mitigation Measure

The following mitigation measure would reduce impacts regarding disrupting tribal cultural resources to a less than significant level.

TCR-1 Unanticipated Discovery of Tribal Cultural Resources. In the event that cultural resources of Native American origin are identified during construction, all earth-disturbing work within the vicinity of the find must be temporarily suspended or redirected until an archaeologist has evaluated the nature and significance of the find and an appropriate Native American representative, based on the nature of the find, is consulted. If the City determines that the resource is a tribal cultural resource and thus significant under CEQA, a mitigation plan shall be prepared and implemented in accordance with state guidelines and in consultation with Native American groups. The plan would include avoidance of the resource or, if avoidance of the resource is infeasible, the plan would outline the appropriate treatment of the

resource in coordination with the archeologist and the appropriate Native American tribal representative.

LESS THAN SIGNIFICANT WITH MITIGATION INCORPORATED

18 Utilities and Service Systems

	Potentially Significant Impact	Less than Significant with Mitigation Incorporated	Less than Significant Impact	No Impact
--	--------------------------------	--	------------------------------	-----------

Would the project:

a. Exceed wastewater treatment requirements of the applicable Regional Water Quality Control Board?	<input type="checkbox"/>	<input type="checkbox"/>	<input checked="" type="checkbox"/>	<input type="checkbox"/>
b. Require or result in the construction of new water or wastewater treatment facilities or expansion of existing facilities, the construction of which could cause significant environmental effects?	<input type="checkbox"/>	<input type="checkbox"/>	<input checked="" type="checkbox"/>	<input type="checkbox"/>
c. Require or result in the construction of new storm water drainage facilities or expansion of existing facilities, the construction of which could cause significant environmental effects?	<input type="checkbox"/>	<input type="checkbox"/>	<input checked="" type="checkbox"/>	<input type="checkbox"/>
d. Have sufficient water supplies available to serve the project from existing entitlements and resources, or are new or expanded entitlements needed?	<input type="checkbox"/>	<input type="checkbox"/>	<input checked="" type="checkbox"/>	<input type="checkbox"/>
e. Result in a determination by the wastewater treatment provider which serves or may serve the project that it has adequate capacity to serve the project's projected demand in addition to the provider's existing commitments?	<input type="checkbox"/>	<input type="checkbox"/>	<input checked="" type="checkbox"/>	<input type="checkbox"/>
f. Be served by a landfill with sufficient permitted capacity to accommodate the project's solid waste disposal needs?	<input type="checkbox"/>	<input type="checkbox"/>	<input checked="" type="checkbox"/>	<input type="checkbox"/>
g. Comply with federal, state, and local statutes and regulations related to solid waste?	<input type="checkbox"/>	<input type="checkbox"/>	<input checked="" type="checkbox"/>	<input type="checkbox"/>

a. *Would the project exceed wastewater treatment requirements of the applicable Regional Water Quality Control Board?*

Water quality in the State of California is regulated by the SWRCB and the nine RWQCBs. The City of Hayward is located in the jurisdiction of the SFRWQCB. Section 303(d) of the CWA requires that states identify water bodies including bays, rivers, streams, creeks, and coastal areas that do not

meet water quality standards and the pollutants that are causing the impairment. Total Maximum Daily Loads (TMDLs) describe the maximum amount of a pollutant that a water body can receive while still meeting established water quality standards. A TMDL requires that all sources of pollution and all aspects of a watershed's drainage system be reviewed and set forth action plans that examine factors and sources adversely affecting water quality and identify specific plans to improve overall water quality and reduce pollutant discharges into impaired water bodies.

The project would connect to the City of Hayward Sanitary District sanitary sewer system. Sanitary sewage from the City's system is treated at the Hayward Water Pollution Control Facility (WPCF). The treatment facility discharges into the San Francisco Bay under a permit with the SFRWQCB. Since the WPCF is considered a publicly-owned treatment facility, operational discharge flows treated at the WPCF would be required to comply with applicable water discharge requirements issued by the SFRWQCB. Compliance with conditions or permit requirements established by the City as well as water discharge requirements outlined by the SFRWQCB would ensure that wastewater discharges coming from the project site and treated by the WPCF system would not exceed applicable SFRWQCB wastewater treatment requirements. Therefore, impacts will be less than significant.

LESS THAN SIGNIFICANT IMPACT

- b. *Would the project require or result in the construction of new water or wastewater treatment facilities or expansion of existing facilities, the construction of which could cause significant environmental effects?*
- e. *Would the project result in a determination by the wastewater treatment provider which serves or may serve the project that it has adequate capacity to serve the project's projected demand in addition to the provider's existing commitments?*

The project site is located in an urban area within the boundaries of the City of Hayward Water District. The project is consistent with the General Plan's LDR and MDR land use designations and would not generate growth beyond that anticipated in the General Plan. The Environmental Impact Report (EIR) for the City's General Plan found that there was adequate capacity at the WPCF to serve development under the General Plan. Therefore, there is adequate capacity at the WPCF to service the project and no expansion of the WPCF would be required (City of Hayward 2013). Impacts will be less than significant.

LESS THAN SIGNIFICANT IMPACT

- c. *Would the project require or result in the construction of new storm water drainage facilities or expansion of existing facilities, the construction of which could cause significant environmental effects??*

Stormwater runoff flows from the site drains into catch basins located along 4th Street. Major storm drainage facilities in Hayward are owned and maintained by the ACFCWCD, and include gravity pipelines predominantly made of reinforced concrete, which discharge to underground storm drain lines or manmade open channels. Storm drain pipes smaller than 30 inches are typically owned by the City and are generally provided within local streets and easements.

This system of stormwater collection and filtration would not change with implementation of the project. However, the project would increase the amount of impervious surfaces on the project site by approximately 95,281 square feet, which would reduce the potential for groundwater recharge, increasing stormwater runoff from the site. However, as discussed in Section 9, *Hydrology and*

City of Hayward
22626 4th Street Residential Project

Water Quality, the proposed project would include silva cells and bioretention areas to assist with groundwater recharge and would be required to comply with all applicable stormwater management requirements. Therefore, the project would not result in the need for new off-site stormwater drainage facilities. Site runoff would be directed to the City's existing municipal storm drainage system, which was designed to accommodate flows resulting from buildout in the project area. The project would be subject to local policies requiring that post-construction runoff volumes be less than or equal to preconstruction volumes (MS4 C.3, discussed further in Section 9). Therefore, expansion of the existing stormwater collection system is not required. Impacts will be less than significant.

LESS THAN SIGNIFICANT IMPACT

- d. *Would the project have sufficient water supplies available to serve the project from existing entitlements and resources, or are new or expanded entitlements needed?*

The project would receive its water from the City of Hayward. The City of Hayward provides water for residential, commercial, industrial, governmental, and fire suppression uses. The City owns and operates its own water distribution system and receives its water from the Hetch Hetchy regional water system, which is owned and operated by the SFPUC. Emergency water supplies are available through connections with Alameda County Water District (ACWD) and East Bay Municipal Utility District (EBMUD) in case of disruption of delivery (City of Hayward 2016b).

The City's Urban Water Management Plan (UWMP) assesses Hayward's water supply reliability, and describes the City's anticipated water demand, water shortage contingency plans, and water conservation strategies. The UWMP is based on the growth projections in the City's General Plan. Major water system projects in the near-term focus on replacing and renovating existing water storage reservoirs to increase storage capacity and improve structural reliability. Hayward has also made extensive efforts to improve the seismic safety of the water system, including seismic retrofits of several reservoirs and improvements to pipes at fault line crossings (City of Hayward 2016b).

As determined in the City's UWMP, there is adequate water supply available to serve anticipated growth in Hayward. The project is consistent with the General Plan's LDR and MDR land use designations and would not generate growth beyond that anticipated in the General Plan. Therefore, there would be sufficient potable water supply to accommodate the anticipated demand increases resulting from the project. Impacts will be less than significant.

LESS THAN SIGNIFICANT IMPACT

- f. *Would the project be served by a landfill with sufficient permitted capacity to accommodate the project's solid waste disposal needs?*
- g. *Would the project comply with federal, state, and local statutes and regulations related to solid waste?*

The City of Hayward provides weekly garbage collection and disposal services through a Franchise Agreement with Waste Management, Inc. (WMI), a private waste management company. WMI subcontracts with a local non-profit, Tri-CED Community Recycling, for residential collection of recyclables. Altamont Landfill is the designated disposal site in the City's Franchise Agreement with WMI, which is approximately 25 miles northeast of the project site. Altamont Landfill is a Class II facility that accepts municipal solid waste from various cities, including Hayward. The landfill occupies a 2,170-acre site of which 472 acres are permitted for landfill. In 2001, the landfill received

County approval to increase capacity, adding 25 years to the life of the landfill and extending the anticipated closure date to the year 2040.

HMC Chapter 5, Article 10 requires that applicants for all construction and demolition projects that generate significant debris recycle 100 percent of all asphalt and concrete and 50 percent of remaining materials. Through these measures, the City plans to meet the statewide diversion goal of 75 percent by 2020.

The Altamont Landfill processes approximately 1,500,000 tons of solid waste per year and has a remaining permitted capacity of 42.4 million tons (WMI 2014). Given the available capacity at the landfill, the incremental additional of solid waste generated by the proposed 41 single-family residences would not cause the facility to exceed its daily permitted capacity. In addition, implementation of the City's recycling programs, including construction debris, would further reduce solid waste generation. Therefore, impacts will be less than significant.

LESS THAN SIGNIFICANT IMPACT

19 Mandatory Findings of Significance

	Potentially Significant Impact	Less than Significant with Mitigation Incorporated	Less than Significant Impact	No Impact
--	--------------------------------	--	------------------------------	-----------

Does the project:

a. Have the potential to substantially reduce the habitat of a fish or wildlife species, cause a fish or wildlife population to drop below self-sustaining levels, eliminate a plant or animal community, reduce the number or restrict the range of a rare or endangered plant or animal or eliminate important examples of the major periods of California history or prehistory?	<input type="checkbox"/>	<input checked="" type="checkbox"/>	<input type="checkbox"/>	<input type="checkbox"/>
b. Have impacts that are individually limited, but cumulatively considerable? (“Cumulatively considerable” means that the incremental effects of a project are considerable when viewed in connection with the effects of past projects, the effects of other current projects, and the effects of probable future projects)?	<input type="checkbox"/>	<input type="checkbox"/>	<input checked="" type="checkbox"/>	<input type="checkbox"/>
c. Have environmental effects which will cause substantial adverse effects on human beings, either directly or indirectly?	<input type="checkbox"/>	<input checked="" type="checkbox"/>	<input type="checkbox"/>	<input type="checkbox"/>

a. *Does the project have the potential to substantially reduce the habitat of a fish or wildlife species, cause a fish or wildlife population to drop below self-sustaining levels, eliminate a plant or animal community, reduce the number or restrict the range of a rare or endangered plant or animal or eliminate important examples of the major periods of California history or prehistory?*

Based on the information and analysis provided throughout this Initial Study, implementation of the project would not substantially degrade the quality of the environment and would not substantially reduce the habitat of a fish or wildlife species, cause a fish or wildlife population to drop below self-sustaining levels, threaten to eliminate a plant or animal community, reduce the number or restrict the range of rare or endangered plants or animals, or eliminate important examples of California history or prehistory. Cultural resources, which illustrate examples of California history and prehistory, are discussed in Section 5, *Cultural Resources*, and Section 17, *Tribal Cultural Resources*. Mitigation measures CUL-1, CUL-2, and TCR-1 have been designed to reduce potential impacts of disturbing archaeological and tribal cultural resources and human remains. Biological resources are

addressed in Section 4, *Biological Resources*. With mitigation measures BIO-1 through BIO-4 related to nesting birds and other protections to riparian habitat and species, the project would not substantially reduce wildlife habitat or population. Based on the ability of the identified mitigation measures to reduce potential impacts to less than significant levels, the project's impacts will be less than significant with mitigation incorporated.

LESS THAN SIGNIFICANT WITH MITIGATION INCORPORATED

- b. *Does the project have impacts that are individually limited, but cumulatively considerable? ("Cumulatively considerable" means that the incremental effects of a project are considerable when viewed in connection with the effects of past projects, the effects of other current projects, and the effects of probable future projects)?*

Cumulative impacts associated with some of the resource areas are addressed in the individual resource sections above: Air Quality, Greenhouse Gases, Water Supply, and Solid Waste (CEQA Guidelines Section 15064(h)(3)) and will be less than significant. Some of the other resource areas were determined to have no impact in comparison to existing conditions and therefore will not contribute to cumulative impacts, such as Mineral Resources and Agricultural Resources. As such, cumulative impacts in these issue areas will also be less than significant (not cumulatively considerable). The project would incrementally increase traffic compared to existing conditions. However, the project will not significantly contribute to cumulative impacts to nearby roadways. The project could potentially result in impacts related to traffic hazards and safety of pedestrian, bicycle, and transit facilities and operations near the project site. However, these impacts are local by nature and specific to the project and would not be cumulatively considerable in combination with other planned or pending projects in the project area. The project involves development of 41 residential units and would be consistent with the City's General Plan designation and density for the site. The project will not result in a significant contribution to cumulatively considerable impacts.

LESS THAN SIGNIFICANT IMPACT

- c. *Does the project have environmental effects which will cause substantial adverse effects on human beings, either directly or indirectly?*

Effects to human beings are generally associated with air quality, noise, traffic safety, geology/soils and hazards/hazardous materials. As discussed in this Initial Study, implementation of the project would result in less than significant environmental impacts with respect to these issue areas with mitigation incorporated. The geotechnical recommendations and Mitigation Measure GEO-1 discussed in Section 6, *Geology and Soils*, would ensure that soils and grounds are stable, and that liquefaction risks are less than significant which would reduce health and safety risks to human beings. In addition, impacts associated with contaminated soil for construction workers, nearby residents, and future residents would be reduced with Mitigation Measure HAZ-1. Further, mitigation measures T-1 to T-4 would reduce traffic safety risks to drivers, pedestrians, and bicyclists and Mitigation Measure N-1 would reduce potential construction noise impacts. With mitigation, the project would not cause substantial adverse effects on human beings, either directly or indirectly. Impacts will be less than significant with mitigation.

LESS THAN SIGNIFICANT WITH MITIGATION INCORPORATED

References

Bibliography

- Alameda County Airport Land Use Commission (ALUC). 2012. Hayward Executive Airport - Airport Land Use Compatibility Plan. [online]: https://www.acgov.org/cda/planning/generalplans/documents/HWD_ALUCP_082012_FULL.pdf Accessed March 2018.
- Alameda County Flood Control & Water Conservation District (ACFCWCD). 2017. San Lorenzo Watershed map webpage. [online]: <https://www.acfloodcontrol.org/resources/explore-watersheds/san-lorenzo-creek-watershed/>. Accessed March 2018.
- Alameda County Transportation Commission (CTC). 2017. Alameda County Congestion Management Program, Chapter 2 Designated CMP Roadway Network. [online]: https://www.alamedactc.org/files/managed/Document/22579/CMP_02_Designated_CMP_Roadway_Network_2017.pdf. Accessed March 2018.
- Association of Bay Area Governments (ABAG). 2013. *Bay Area Plan Projections 2013*. [online]: <http://www.abag.ca.gov/planning/housing/projections13.html>. Accessed March 2018.
- . 2017a. *Plan Bay Area 2040 Final Supplemental Report*. Land Use Modeling Report. [online]: http://2040.planbayarea.org/sites/default/files/2017-07/Land_Use_Modeling_PBA2040_Supplemental%20Report_7-2017.pdf. Accessed March 2018.
- . 2017b. Plan Bay Area 2040 Draft Plan. <http://planbayarea.org/>. Accessed March 2018.
- Association of Environmental Professionals (AEP). 2016. *Beyond 2020 and Newhall: A Field Guide to New CEQA Greenhouse Gas Thresholds and Climate Action Plan Targets for California*. [online]: https://www.califaep.org/images/climate-change/AEP-2016_Final_White_Paper.pdf. Accessed March 2018.
- Barron, J.A. 1989. Diatom Stratigraphy of the Monterey Formation and Related Rocks, San Jose 30 x 60 Minute Quadrangle, California. U.S. Geological Survey Open-File Report 89 565.
- Bartow, J.A., and Nilsen, T.H. 1990. Review of the Great Valley Sequence, Eastern Diablo Range and Northern San Joaquin Valley, Central California. U.S. Geological Survey Open-File Report 90 226.
- Bay Area Air Quality Management District (BAAQMD). 2012. Risk and Hazard Screening Analysis Process Flow Chart. [online]: http://www.baaqmd.gov/~/_media/files/planning-and-research/ceqa/updated-screening-approach-flow-chart_may-2012.pdf?la=en. Accessed March 2018.
- . 2017a. Air Quality Standards and Attainment Status. [online]: <http://www.baaqmd.gov/research-and-data/air-quality-standards-and-attainment-status>. Accessed March 2018.

- . 2017b. Final 2017 Clean Air Plan. Spare the Air Cool the Climate: A Blueprint for Clean Air and Climate Protection. [online]: http://www.baaqmd.gov/~media/files/planning-and-research/plans/2017-clean-air-plan/attachment-a_-_proposed-final-cap-vol-1-pdf.pdf?la=en. Accessed March 2018.
- . 2017c. *California Environmental Quality Act Air Quality Guidelines*. [online]: http://www.baaqmd.gov/~media/files/planning-and-research/ceqa/ceqa_guidelines_may2017-pdf.pdf?la=en. Accessed March 2018.
- California Air Pollution Control Officers Association (CAPCOA). 2008. CEQA and Climate Change: Addressing Climate Change through California Environmental Quality Act (CEQA).
- California Air Resources Board (CARB). 2014. 2020 BAU Forecast. [online]: http://www.arb.ca.gov/cc/inventory/data/tables/2020_bau_forecast_by_scoping_category_2014-05-22.pdf. Accessed March 2018.
- California Building Standards Commission. 2017. California Building Standards Code (California Code of Regulations, Title 24). [online]: <http://www.bsc.ca.gov/codes.aspx>. Accessed March 2018.
- California Department of Conservation. 2016. Alameda County Important Farmland 2014. [online]: <ftp://ftp.consrv.ca.gov/pub/dlrp/FMMP/pdf/2014/ala14.pdf>. Accessed March 2018.
- California Department of Finance (DOF). 2015. Demographics. [online]: <http://www.dof.ca.gov/Forecasting/Demographics/>. Accessed March 2018.
- . 2017. E-1 Population Estimate for Cities, Counties, and the State – January 1, 2016 and 2017. [online]: <http://www.dof.ca.gov/Forecasting/Demographics/Estimates/E-1/>. Accessed March 2018.
- California Department of Fish and Wildlife (CDFW). 2017. *Special Animals List*. Biogeographic Data Branch, California Natural Diversity Database. October 2017.
- _____. 2018a. California Natural Diversity Database (CNDDDB) - Rarefind 5. [online]: <https://www.wildlife.ca.gov/Data/CNDDDB/Maps-and-Data>. Accessed February 2018.
- _____. 2018b. Biogeographic Information and Observation System (BIOS). [online]: <http://bios.dfg.ca.gov>. Accessed February 2018.
- _____. 2018c. *Special Vascular Plants, Bryophytes, and Lichens List*. Biogeographic Data Branch, California Natural Diversity Database. January 2018.
- California Department of Forestry and Fire (CalFire). 2007. Fire Hazard Severity Zones in SRA. [online]: http://frap.fire.ca.gov/webdata/maps/alameda/fhszs_map.1.pdf. Accessed March 2018.
- . 2008. Very High Fire Hazard Severity Zones in LRA. [online]: http://frap.fire.ca.gov/webdata/maps/alameda/fhszl_map.1.pdf. Accessed March 2018.
- California Department of Transportation (Caltrans). 2011. State of California Scenic Highways. [online]: http://www.dot.ca.gov/hq/LandArch/16_livability/scenic_highways/index.htm. Accessed March 2018.
- California Department of Water Resources. 2009. *California Water Plan Update 2009 - San Francisco Bay, Integrated Water Management. Bulletin 160-09*, Volume 3, Regional Reports. Sacramento, CA. 2009. Accessed March 2018. http://www.water.ca.gov/waterplan/docs/cwpu2009/0310final/v3_sanfrancisco_cwp2009.pdf.

City of Hayward
22626 4th Street Residential Project

- . 2015. Alameda Watershed Management Area.
https://www.waterboards.ca.gov/sanfranciscobay/water_issues/programs/watershed/WMI/WMI_Sec_3/3_2.pdf
- California Environmental Protection Agency (Cal EPA). 2015. CalEPA Website. [online]:
<http://www.calepa.ca.gov/>. Accessed March 2018.
- California Geological Survey (CGS). 2002. California Geomorphic Provinces, Note 36.
- . 2012. *Earthquake Zones of Required Investigation Hayward Quadrangle*. Released September 21, 2012. [online]: http://gmw.conservation.ca.gov/SHP/EZRIM/Maps/HAYWARD_EZRIM.pdf. Accessed March 2018.
- California Native Plant Society (CNPS). Rare Plant Program. 2018. Inventory of Rare and Endangered Plants (online edition, v8-02). California Native Plant Society, Sacramento, CA. [online]:
<http://www.rareplants.cnps.org>. Accessed February 2018.
- ENGE0. 2017. Preliminary Geotechnical Assessment – B Street Project, Hayward, California.
- Federal Highway Administration (FHWA). 2006. Construction Noise Handbook. [online]:
http://www.fhwa.dot.gov/environment/noise/construction_noise/handbook/. Accessed March 2018.
- Federal Transit Administration (FTA). 2006. Chapter 12: Noise and Vibration During Construction. In FTA Guidance Manual for Transit Noise and Vibration Impact Assessment. [online]:
<http://www.hmmh.com/fta-manual-transit-noise-vibration-assessment-2006.html>. Accessed March 2018.
- Fossen, H. 2010. Structural Geology. Cambridge Press, New York.
- Graymer, R.W. 2000. Geologic map and map database of the Oakland metropolitan area, Alameda, Contra Costa, and San Francisco Counties, California. U.S. Geological Survey, Miscellaneous Field Studies Map MF-2342, scale 1:50,000.
- Graymer, R.W., Jones, D.L., and Brabb, E.E. 1996. Preliminary Geologic Map Emphasizing Bedrock Formations in Alameda County, California: A Digital Database. U.S. Geological Survey Open-File Report 96 252, scale 1:75,000.
- Hayward Area Recreation and Park District (H.A.R.D). 2018. “About Us” webpage. [online]:
<https://www.haywardrec.org/27/About-Us>. Accessed April 2018.
- Hayward, City of. 2010. Urban Water Management Plan. [online]:
<https://www.water.ca.gov/LegacyFiles/urbanwatermanagement/2010uwmps/Hayward,%20City%20of/Hayward%202010%20UWMP%20with%20Appendices%20June%202010.pdf>. Accessed March 2018.
- . 2013. Hayward 2040 General Plan Draft Environmental Impact Report. [online]:
https://www.hayward-ca.gov/sites/default/files/documents/Hayward%20GPU%20Public%20Release%20Draft%20EIR_1-30-14.pdf. Accessed March 2018.
- . 2014a. *Hayward 2040 General Plan Background Report, Public Review Draft January 2014*. [online]: https://www.hayward-ca.gov/sites/default/files/documents/Hayward%20General%20Plan%20Update%20Background%20Report_1-31-14_0.pdf. Accessed March 2018.

- . 2014b. Hayward 2040 General Plan. [online]: https://www.hayward-ca.gov/sites/default/files/documents/General_Plan_FINAL.pdf. Accessed March 2018.
- . 2016a. *Local Hazard Mitigation Plan*. [online]: <https://www.hayward-ca.gov/sites/default/files/pdf/2016%20City%20of%20Hayward%20Local%20Hazard%20Mitigation%20Plan.pdf> . Accessed March 2018.
- . 2016b. *2015 Urban Water Management Plan*. [online]: <https://www.hayward-ca.gov/documents/2015-urban-water-management-plan-0>. Accessed March 2018.
- . 2018. Hayward Area Recreation and Park District – A Brief History. [online]: <https://www.haywardrec.org/27/About-Us>. Accessed March 2018.
- Hayward Fire Department. 2018. “Stations” webpage. [online]: <https://www.hayward-ca.gov/fire-department/stations>. Accessed March 2018.
- Helley, E.J., and Graymer, R.W. 1997. Quaternary Geology of Alameda County, and Parts of Contra Costa, Santa Clara, San Mateo, San Francisco, Stanislaus, and San Joaquin Counties, California: A Digital Database. U.S. Geological Survey Open File Report 97 97, scale 1:100,000.
- HortScience, Inc. 2017. Arborist Report – B Street, Hayward, CA.
- Jepson Flora Project. 2018. Jepson eFlora. Available at: <http://ucjeps.berkeley.edu/eflora/>. Accessed February 2018.
- Lockhart, Bill, Nate Briggs, Beau Schriever, Carol Serr, and Bill Lindsey. 2017. The Latchford Glass Factories. Society for Historical Archaeology. [online]: <https://sha.org/bottle/pdffiles/LatchfordGlass.pdf/>. Accessed March 2018.
- National Park Service (NPS). 1983. Archaeological and Historic Preservation: Secretary of the Interior’s Standards and Guidelines. [online]: https://www.nps.gov/history/local-law/arch_stnds_0.htm. Accessed March 2018.
- Natural Resources Conservation Service (NRCS). 2018. Web Soil Survey. Soil Survey Area: Alameda County, California. Soil Survey Data: Version 16, Sep 26, 2017. <http://websoilsurvey.nrcs.usda.gov/>. Accessed February 2018.
- Ripley Design Group. 2017. B St. Hayward, CA Preliminary Landscape Plan. Dated November 13, 2017.
- Ruggeri-Jensen-Azar (RJA). 2017a. Vesting Tentative Map Tract 8427 – B Street Existing Conditions & Demolition Plan. Dated November 10, 2017.
- _____. 2017b. Vesting Tentative Map Tract 8427 – B Street Preliminary Stormwater Treatment Plan. Dated November 10, 2017.
- San Francisco Public Utilities Commission (SFPUC). 2017. “About us – Water” webpage. [online]: <https://sfwater.org/index.aspx?page=355>. Accessed March 2018.
- San Francisco Bay Regional Water Quality Control Board (SFRWCQB). 2017. *Water Quality Control Plan for the San Francisco Bay Basin*, Chapter 2: Beneficial Uses. [online]: https://www.waterboards.ca.gov/sanfranciscobay/water_issues/programs/planningtmdls/basin_plan/web/docs/bp_ch2+tables.pdf. Accessed March 2018.
- Schemmann, K., Unruh, J.R., and Moores, E.M. 2008. Kinematics of Franciscan Complex Exhumation: New Insights from the Geology of Mount Diablo, California. *Geological Society of America Bulletin* 120, no. 5-6, p. 543–555.

City of Hayward
22626 4th Street Residential Project

Society of Vertebrate Paleontology (SVP). 2010. Standard Procedures for the Assessment and Mitigation of Adverse Impacts to Paleontological Resources. Society of Vertebrate Paleontology Impact Mitigation Guidelines Revision Committee.

United States Environmental Protection Agency (EPA). 2003. Protecting Water Quality from Urban Runoff. https://www3.epa.gov/npdes/pubs/nps_urban-facts_final.pdf. Accessed March 2018.

United States Fish and Wildlife Service (USFWS). 2018a. Information for Planning and Consultation (IPaC). Available at: <https://ecos.fws.gov/ipac/>. Accessed February 2018.

_____. 2018b. Critical Habitat Portal. Available at: <https://fws.maps.arcgis.com/home/webmap/viewer.html?webmap=9d8de5e265ad4fe09893cf75b8dbfb77> Accessed February 2018.

_____. 2018c. National Wetlands Inventory (NWI). Version 2. Available at: <https://www.fws.gov/wetlands/Data/Mapper.html>. Accessed February 2018.

United States Geological Survey (USGS). 2017. National Hydrography Dataset. [online]: <https://nhd.usgs.gov/data.html>. Accessed February 2018.

Waste Management, Inc. [WMI]. 2014. Altamont Landfill and Resource Recovery Facility. [online]: https://www.wmsolutions.com/pdf/factsheet/Altamont_Landfill.pdf. Accessed March 2018.

Working Group on California Earthquake Probabilities (WGCEP). 2015. Long-Term Time-Dependent Probabilities for the Third Uniform California Earthquake Rupture Forecast (UCERF3). [online]: <https://pubs.geoscienceworld.org/ssa/bssa/article-abstract/105/2A/511/331850/long-term-time-dependent-probabilities-for-the?redirectedFrom=fulltext>. Accessed March 2018.

List of Preparers

Rincon Consultants, Inc. prepared this IS-MND under contract to the City of Hayward. Persons involved in data gathering analysis, project management, and quality control are listed below.

RINCON CONSULTANTS, INC.

Abe Leider, AICP CEP, Principal in Charge
 Karly Kaufman, MESM, Project Manager
 Eric Schaad, Senior Biologist/Project Manager
 Samantha Kehr, Associate Biologist
 Steven Treffers, Senior Architectural Historian
 Heather Clifford, Associate Paleontologist
 Jessica DeBusk, Principal Investigator, Paleontologist
 Hannah Haas, M.A., RPA, Archaeologist
 Matthew Long, Senior Environmental Scientist
 Chris Jackson, Technical Editor
 Debra Jane Seltzer, Production Specialist

This page intentionally left blank.

Appendix A

Arborist Report

Arborist Report

**B Street
Hayward, CA**

**PREPARED FOR:
Dutra Land & Consulting Services
43360 Mission Blvd., Suite #230
Hayward, CA 94539**

**PREPARED BY:
HortScience, Inc.
325 Ray Street
Pleasanton, CA 94566**

Revised June 5, 2017



**Arborist Report
B Street
Hayward, CA**

Table of Contents

	Page
Introduction and Overview	1
Assessment Methods	1
Description of Trees	2
Suitability for Preservation	4
Evaluation of Impacts and Recommendations	6
Appraisal Value	7
Tree Preservation Guidelines	10

List of Tables

Table 1. Condition ratings and frequency of occurrence of trees	2
Table 2. Tree suitability for preservation	6
Table 3: Tree disposition	8

Attachments

Tree Assessment Plan

Tree Assessment Form

Tree Appraisal Value Table

Tree Appraisal Calculation Table

Arborist Report B Street Hayward, CA

Introduction and Overview

Dutra Enterprises is proposing to develop two properties located on the northern and southern sides of B Street and 4th Street in Hayward, CA. Both sites currently consist of dirt lots with some paved areas. The northern site has four existing structures, and the southern site has one structure. HortScience, Inc. was asked to prepare an **Arborist Report** as a part of the submission to the City of Hayward.

This report provides the following information:

1. An assessment of each tree's health, structure, suitability for preservation and protected status (Municipal Code Chapter 18.215) within and adjacent to the proposed project area.
2. An evaluation of impacts to trees based on construction plans.
3. Guidelines for tree preservation throughout the planned, demolition and construction phases of the project.

Assessment Methods

Trees were assessed on December 19, 2016. All trees 4" and greater in diameter were included in the survey, as required by the City of Hayward. The assessment procedure consisted of the following steps:

1. Identifying the tree as to species;
2. Tagging each tree with an identifying number and recording its location on a map;
3. Measuring the trunk diameter at a point 54" above grade;
4. Evaluating the health and structural condition using a scale of 1 – 5:
 - 5** - A healthy, vigorous tree, reasonably free of signs and symptoms of disease, with good structure and form typical of the species.
 - 4** - Tree with slight decline in vigor, small amount of twig dieback, minor structural defects that could be corrected.
 - 3** - Tree with moderate vigor, moderate twig and small branch dieback, thinning of crown, poor leaf color, moderate structural defects that might be mitigated with regular care.
 - 2** - Tree in decline, epicormic growth, extensive dieback of medium to large branches, significant structural defects that cannot be abated.
 - 1** - Tree in severe decline, dieback of scaffold branches and/or trunk; most of foliage from epicormics; extensive structural defects that cannot be abated.
5. Rating the suitability for preservation as "high", "moderate" or "low". Suitability for preservation considers the health, age and structural condition of the tree, and its potential to remain an asset to the site for years to come.

High: Trees with good health and structural stability that have the potential for longevity at the site.

Moderate: Trees with somewhat declining health and/or structural defects than can be abated with treatment. The tree will require more intense management and monitoring, and may have shorter life span than those in 'high' category.

Low: Trees in poor health or with significant structural defects that cannot be mitigated. Tree is expected to continue to decline, regardless of treatment. The species or individual may have characteristics that are undesirable for landscapes, and generally are unsuited for use areas.

Description of Trees

One hundred and nine (109) trees were assessed, representing 27 species (Table 1) including five off-site trees and nine street trees. The diverse group of species found was typical of those found in bay area landscapes. Trees were generally not maintained; however, only 16 trees (15%) were in poor condition, 71 (65%) were in fair condition and 22 (20%) were in good condition. Descriptions of each tree are found in the **Tree Assessment Form** and approximate locations are shown on the **Tree Assessment Plan** (see attachments).

**Table 1: Condition ratings and frequency of occurrence of trees
B Street, Hayward, CA**

Common Name	Scientific Name	Condition			Total
		Poor (1-2)	Fair (3)	Good (4-5)	
Blackwood acacia	<i>Acacia melanoxylon</i>	5	4	-	9
Incense cedar	<i>Calocedrus decurrens</i>	-	3	-	3
Deodar cedar	<i>Cedrus deodara</i>	-	1	-	1
Camphor	<i>Cinnamomum camphora</i>	1	1	-	2
Lemon	<i>Citrus limon</i>	-	1	-	1
Orange	<i>Citrus sinensis</i>	-	1	-	1
Grapefruit	<i>Citrus x paradisi</i>	-	1	-	1
Bronze loquat	<i>Eriobotrya deflexa</i>	-	-	1	1
Blue gum	<i>Eucalyptus globulus</i>	2	-	-	2
Silver dollar gum	<i>Eucalyptus polyanthemos</i>	-	2	-	2
Fig	<i>Ficus carica</i>	-	2	-	2
English walnut	<i>Juglans regia</i>	-	4	2	6
Hollywood juniper	<i>Juniperus chinensis</i> 'Kaizuka'	-	2	-	2
Glossy privet	<i>Ligustrum lucidum</i>	-	7	-	7
Apple	<i>Malus domestica</i>	1	-	-	1
Avocado	<i>Persea americana</i>	-	1	1	2
Monterey pine	<i>Pinus radiata</i>	-	2	3	5
Cherry	<i>Prunus avium</i>	3	1	-	4
Carolina cherry laurel	<i>Prunus caroliniana</i>	-	5	-	5
Coast live oak	<i>Quercus agrifolia</i>	1	15	12	28
Black locust	<i>Robinia pseudoacacia</i>	-	2	-	2
Chinese tallow tree	<i>Sapium sebiferum</i>	-	8	-	8
California pepper	<i>Schinus molle</i>	1	2	-	3
Coast redwood	<i>Sequoia sempervirens</i>	1	4	2	7
American arborvitae	<i>Thuja orientalis</i>	-	1	-	1
California bay	<i>Umbellularia californica</i>	1	1	-	2
Giant yucca	<i>Yucca elephantipes</i>	-	1	-	1
Total		16	72	21	109

The two largest trees evaluated were deodar cedar #34 and blue gum #10. The cedar had seven trunks which ranged in diameter from 11 to 20". Deodar cedar #34 was in fair condition with a symmetrical crown and twig and branch dieback (Photo 1). Blue gum #10 was notable for its size with a 79" diameter. The tree was rated in poor condition with base and canopy engulfed in ivy; multiple attachments and dieback (Photo 2).

Photo 2, below right. Blue gum the largest tree assessed (79" trunk diameter).



Photo 1, below left. Deodar cedar #34 was in fair condition with seven trunks.



The most prevalent species at the site was coast live oak with 28 trees. The Coast live oaks ranged in trunk diameter, from 4 to 30", and condition. One live oak was in poor condition, 15 were in fair condition and 12 were in good condition. Live oaks #17, 22 – 31 were growing in a cluster of trees and had sinuous suppressed growth and generally good vigor. Trees #32, 33, 38, 39, 41, 45, 47 – 49, 53, 56 – 59 were growing as individual trees with larger individual canopies (Photo 3).

Photo 3. Tree #31 and 32 were rated in fair condition. Tree #31 had sinuous suppressed form, and tree #32 had a larger crown with vigorous growth.

Eighteen (18) conifers were evaluated; seven coast redwoods; four Monterey pines; three incense cedars; two Hollywood junipers and an American arborvitae. The redwoods were mature with diameters of 22 to 40". The Monterey pines were juvenile in development with diameters from five to seven inches; incense cedars were semi-mature to mature with trunk diameters of 16 to 22"; Hollywood



junipers were 14 and 13", respectively, and the arborvitae had multiple stems with 8 and 3" diameters. All the conifers were in fair or good condition, except for redwood #21 which was in poor condition with little live foliage. Conifers in good condition tended to have leans or sweeping trunks. Trees in fair condition had more dieback than trees in good and excellent condition (Photo 4).

Photo 4. Tree #54 was in fair condition with a leaning trunk and tip dieback.

Twelve (12) fruit trees were assessed: four cherries two; avocados; two figs; one apple; one grapefruit; one lemon and one orange. The fruit trees had a wide range in trunk diameters measuring from 4 to 29". Their conditions ranged from poor (5 trees) with one in good and fair condition (6 trees). The fruit trees had multiple branches originating from one point, poor form, decay, dieback, suppressed growth, good vigor and full crowns.

Nine blackwood acacia trees were assessed. The acacias ranged in trunk diameter from 4 to 24" with five trees in poor condition and four in fair condition. Blackwood acacias in fair condition had fair form and good vigor. Acacias in poor condition had narrow or leaning canopies and poor vigor.

Eight Chinese tallow street trees lined B Street. All tallow trees were young trees with diameters ranging in size from 6 to 14" and in fair condition. This group of trees had good upright form; trees #107 – 109 were planted under the utility lines but had not been pruned for clearance. Trees #105 and 106 had a history of branch failure.

The City of Hayward protects all trees 8" and larger in diameter, native trees 4" and larger in diameter and street trees of any size. Based on this definition, 78 trees are protected, eight of which are street trees (#102 – 109). Designations for individual trees are provided in the **Tree Assessment Form** (see *Exhibits*).

Suitability for Preservation

Before evaluating the impacts that will occur during development, it is important to consider the quality of the tree resource itself, and the potential for individual trees to function well over an extended length of time. Trees that are preserved on development sites must be carefully selected to make sure that they may survive development impacts, adapt to a new environment and perform well in the landscape.

Our goal is to identify trees that have the potential for long-term health, structural stability and longevity. For trees growing in open fields, away from areas where people and property are present, structural defects and/or poor health presents a low risk of damage or injury if they fail. However, we must be concerned about safety in use areas. Therefore, where development encroaches into existing plantings, we must consider their structural stability as well as their potential to grow and thrive in a new environment. Where development will not occur, the normal life cycles of decline, structural failure and death should be allowed to continue.



Evaluation of suitability for preservation considers several factors:

- **Tree health**
Healthy, vigorous trees are better able to tolerate impacts such as root injury, demolition of existing structures, changes in soil grade and moisture, and soil compaction than are non-vigorous trees. For example, coast live oak #57 was in good health and would be well suited for retention.
- **Structural integrity**
Trees with significant amounts of wood decay and other structural defects that cannot be corrected are likely to fail. Such trees should not be preserved in areas where damage to people or property is likely. Coast redwood #21 and coast live oak #30 were both in poor condition and should be removed regardless of construction impacts.
- **Species response**
There is a wide variation in the response of individual species to construction impacts and changes in the environment. Coast live oaks are generally more tolerant of construction impacts than eucalyptus, fruit trees or acacias.
- **Tree age and longevity**
Old trees, while having significant emotional and aesthetic appeal, have limited physiological capacity to adjust to an altered environment. Young trees are better able to generate new tissue and respond to change. A good example of this is tree #94, the small Monterey pine would be well suited for retention.
- **Invasiveness**
Species which spread across a site and displace desired vegetation are not always appropriate for retention. This is particularly true when indigenous species are displaced. The California Invasive Plant Inventory Database (<http://www.cal-ipc.org/paf/>) lists species identified as being invasive. Hayward is part of the Central West Floristic Province. Blackwood acacia and blue gum are listed as having limited invasiveness. Chinese tallow tree is listed as having moderate invasiveness.

Each tree was rated for suitability for preservation based upon its age, health, structural condition and ability to safely coexist within a development environment (Table 2). We consider trees with high suitability for preservation to be the best candidates for preservation. We do not recommend retention of trees with low suitability for preservation in areas where people or property will be present. Retention of trees with moderate suitability for preservation depends upon the intensity of proposed site changes.

**Table 2: Tree suitability for preservation
B Street, Hayward, CA**

High	These are trees with good health and structural stability that have the potential for longevity at the site. Six trees were rated having high suitability for preservation: coast live oaks #57 – 59; English walnut #92; Monterey pine #94 and avocado #99.
Moderate	Trees in this category have fair health and/or structural defects that may be abated with treatment. Trees in this category require more intense management and monitoring, and may have shorter life-spans than those in the “high” category. Forty-two (42) trees had moderate suitability for preservation: coast live oaks #38, 39, 41, 45 – 49, 53 and 56; Chinese tallow tree #102 – 109; Coast redwood #1, 2, 5 and 8; Monterey pine #95 -98; English walnut #16, 82 and 91; blackwood acacia #35 and 43; incense cedar #50 and 54; silver dollar gum #66 and 67; bronze loquat #19; California bay #6; common privet #100; deodar cedar #34; giant yucca #90; grapefruit #76 and orange #89.
Low	Trees in this category are in poor health or have significant defects in structure that cannot be abated with treatment. These trees can be expected to decline regardless of management. The species or individual tree may possess either characteristics that are undesirable in landscape settings or be unsuited for use areas. Sixty one (61) trees had low suitability of preservation: fifteen (15) coast live oaks; blackwood acacia #36, 37, 42, 44, 72 - 74; common privet #3, 14, 68, 69, 70 and 88; Carolina cherry laurel #83 – 87; cherry #60, 61, 71 and 75; California pepper #7, 77 and 78; coast redwood #21, 40 and 64; black locust #51 and 52; blue gum #10 and 20; camphor #65 and 101; English walnut #11 and 12; fig #15 and 62; Hollywood juniper #80 and 81; American arborvitae #79; apple #93; avocado #13; California bay #18; incense cedar #55 and lemon #63.

Evaluation of Impacts and Recommendations

Appropriate tree retention is a practical match between the location and intensity of construction activities with the quality and health of trees. The tree assessment was the reference point for tree condition and quality. Impacts from the proposed project were assessed using the Existing Conditions B Street dated May 9, 2017 created by Ruggeri, Jenson, Azar Engineers, Planners and Surveyors. Trunk locations, soil remediation area and site plan were shown on the plan. In addition, I discussed soil remediation requirements with the geotechnical consultant.

The development will construct detached single-family residential units with private streets and landscaping. Development will encompass almost the entire site. Soil remediation will remove contaminated soil from most of the north side of the site. Remediation will require significant excavation, leaving little opportunity for tree preservation and protection in this area

Based on my observations of the trees and assessment of plans, I recommend preservation of 31 on-site trees (Table 3). Included in this group are:

- Coast live oaks #57 and 58. Impacts to these trees occur from installation of the new street. Given the condition of the trees and tolerance of the species, impacts associated with the project should be within their tolerance.
- A grove of oaks on the north property line: trees #16, 17, 18, 20, 22 – 29 and 32 as well as coast live oak #48. These trees are adjacent to soil remediation areas.
- Trees #33, 52, 53, 66 and 67 are more than 20' from any construction and are considered out of the project area. These trees are expected to receive minimal impacts from the construction process.
- Trees #102 – 109 are located along B Street.
- Five off-site trees: #8, 16, 17, 56, and 66. Coast live oak (#56) will require significant reduction pruning in order to construct the home.

Seventy-eight (78) trees, 48 protected, will be removed for construction (Table 3). In addition to trees that are located within and immediately adjacent to areas proposed for development, trees must be removed in order to complete soil remediation. Included in this group are 15 trees (7 Protected) that are in poor condition.

Appraisal Value

The City of Hayward requires an estimate of value be prepared for trees on the property. In appraising the value of the trees, we employed the standard methods found in ***Guide for Plant Appraisal***, 9th edition (International Society of Arboriculture, Champaign IL, 2000). In addition, we referred to ***Species Classification and Group Assignment*** (2004), a publication of the Western Chapter of the International Society of Arboriculture. These two documents outline the methods employed in tree appraisal.

The value of landscape trees is based on four factors: size, species, condition and location. Size is measured as trunk diameter, normally 54" above grade. The species factor considers the adaptability and appropriateness of the plant in the East Bay area. The ***Species Classification and Group Assignment*** lists recommended species ratings. Condition reflects the health and structural integrity of the individual. The location factor considers the site, placement and contribution of the tree in its surrounding landscape.

The appraised value of each tree is included in the ***Tree Appraisal***, see exhibits. The value of the 109 trees is \$369,750. The value of the trees to be preserved is \$123,780. The value of the trees to be removed based on condition is \$27,100 and the value of trees to be removed for the project is \$196,150.

**Table 3: Tree disposition
B Street, Hayward, CA**

Tree No.	Species	Trunk Diameter (in.)	Prot'd. Tree	Disposition.	Comments
1	Coast redwood	40	Yes	Remove	In project area
2	Coast redwood	31	Yes	Remove	In project area
3	Glossy privet	9,6,5,4,4, 4,3,2	Yes	Remove	In project area
4	Coast live oak	21	Yes	Remove	In project area
5	Coast redwood	33	Yes	Remove	In project area
6	California bay	7,7	No	Remove	In project area
7	California pepper	32	Yes	Remove	In project area
8	Coast redwood	22	Yes	Preserve	12 ' from home
9	Coast live oak	14	Yes	Remove	Soil remediation
10	Blue gum	79	Yes	Remove	Condition removal
11	English walnut	6	No	Remove	In project area
12	English walnut	4	No	Remove	In project area
13	Avocado	29	Yes	Remove	In project area
14	Glossy privet	11,8	Yes	Remove	In project area
15	Fig	9,7,5,5	Yes	Remove	In project area
16	English walnut	10	Yes	Preserve	5' from soil remediation
17	Coast live oak	14	Yes	Preserve	5' from soil remediation
18	California bay	4,2,2	No	Preserve	5' from soil remediation
19	Bronze loquat	8,5	Yes	Preserve	5' from soil remediation
20	Blue gum	49	Yes	Remove	Condition removal
21	Coast redwood	22	Yes	Remove	Condition removal
22	Coast live oak	7	Yes	Preserve	6' from soil remediation
23	Coast live oak	7	Yes	Preserve	8' from soil remediation
24	Coast live oak	12	Yes	Preserve	10 ' or greater from soil
25	Coast live oak	7	Yes	Preserve	10 ' or greater from soil
26	Coast live oak	8	Yes	Preserve	10 ' or greater from soil
27	Coast live oak	4	Yes	Preserve	10 ' or greater from soil
28	Coast live oak	17	Yes	Preserve	10 ' or greater from soil
29	Coast live oak	20	Yes	Preserve	10 ' or greater from soil
30	Coast live oak	20	Yes	Remove	Condition removal
31	Coast live oak	8	Yes	Remove	1' from soil remediation
32	Coast live oak	16	Yes	Preserve	4' from soil remediation
33	Coast live oak	30	Yes	Preserve	20' or greater from structure
34	Deodar cedar	20,19,14,1 4,14,13,11	Yes	Remove	In project area
35	Blackwood acacia	24	Yes	Remove	In project area
36	Blackwood acacia	9,3	Yes	Remove	In project area
37	Blackwood acacia	6	No	Remove	In project area
38	Coast live oak	15	Yes	Remove	In project area
39	Coast live oak	5	Yes	Remove	In project area
40	Coast redwood	35	Yes	Remove	In project area
41	Coast live oak	16,6	Yes	Remove	In project area

Tree No.	Species	Trunk Diameter (in.)	Prot'd. Tree	Disposition.	Comments
42	Blackwood acacia	17	Yes	Remove	Condition removal
43	Blackwood acacia	7,4	No	Remove	In project area
44	Blackwood acacia	7,4	No	Remove	Condition removal
45	Coast live oak	16	Yes	Remove	Soil remediation
46	Coast live oak	26	Yes	Remove	Soil remediation
47	Coast live oak	16,6	Yes	Remove	In soil remediation area
48	Coast live oak	28	Yes	Preserve	10' from structure
49	Coast live oak	10	Yes	Remove	2' from curb
50	Incense cedar	16	Yes	Remove	2' from curb
51	Black locust	11	Yes	Remove	3' from project area
52	Black locust	12,8	Yes	Preserve	26' from project area
53	Coast live oak	23	Yes	Preserve	Out of project area
54	Incense cedar	22	Yes	Remove	In project area
55	Incense cedar	22	Yes	Remove	In project area
56	Coast live oak	21	Yes	Preserve	11' from structure
57	Coast live oak	27	Yes	Preserve	10' on either side
58	Coast live oak	27	Yes	Preserve	20' on either side
59	Coast live oak	9,8	Yes	Remove	In project area
60	Cherry	6	No	Remove	In project area
61	Cherry	4	No	Remove	Condition removal
62	Fig	7,7,5	No	Remove	In project area
63	Lemon	4,4	No	Remove	In project area
64	Coast redwood	28,9	Yes	Remove	In project area
65	Camphor	27,21	Yes	Remove	In project area
66	Silver dollar gum	26	Yes	Preserve	24' from structure
67	Silver dollar gum	28	Yes	Preserve	24' from structure
68	Glossy privet	4,4,4,1,1	No	Remove	In project area
69	Glossy privet	9	Yes	Remove	In project area
70	Glossy privet	8	Yes	Remove	In project area
71	Cherry	6	No	Remove	Condition removal
72	Blackwood acacia	4	No	Remove	Condition removal
73	Blackwood acacia	4	No	Remove	Condition removal
74	Blackwood acacia	4,4,3,3,3, 2,2	No	Remove	Condition removal
75	Cherry	5,5,4,3,2	No	Remove	Condition removal
76	Grapefruit	7	No	Remove	In project area
77	California pepper	28	Yes	Remove	In project area
78	California pepper	38,29	Yes	Remove	Condition removal
79	American Arborvitae	8,6	Yes	Remove	In project area
80	Hollywood juniper	14	Yes	Remove	In project area
81	Hollywood juniper	13	Yes	Remove	In project area
82	English walnut	4,4	No	Remove	In project area
83	Carolina cherry laurel	9,6,6,5	Yes	Remove	In project area
84	Carolina cherry laurel	7,6,2	No	Remove	In project area
85	Carolina cherry laurel	19,9	Yes	Remove	In project area

Tree No.	Species	Trunk Diameter (in.)	Prot'd. Tree	Disposition.	Comments
86	Carolina cherry laurel	11,10,10, 7,5,3	Yes	Remove	In project area
87	Carolina cherry laurel	7,7,7,3,2,2	No	Remove	In project area
88	Glossy privet	8	Yes	Remove	In project area
89	Orange	6,3,3	No	Remove	In project area
90	Giant yucca	6,5,5,4	No	Remove	In project area
91	English walnut	26	Yes	Remove	In project area
92	English walnut	38	Yes	Remove	In project area
93	Apple	6,6,4,3,3, 3,2,2,2,2	No	Remove	Condition removal
94	Monterey pine	5	No	Remove	In project area
95	Monterey pine	6	No	Remove	In project area
96	Monterey pine	6	No	Remove	In project area
97	Monterey pine	7	No	Remove	In project area
98	Monterey pine	6	No	Remove	In project area
99	Avocado	4	No	Remove	In project area
100	Glossy privet	6,5,4,3,2	No	Remove	In project area
101	Camphor	27	Yes	Remove	Condition removal
102	Chinese tallow tree	11	Yes	Preserve	In ROW
103	Chinese tallow tree	14	Yes	Preserve	In ROW
104	Chinese tallow tree	12	Yes	Preserve	In ROW
105	Chinese tallow tree	13	Yes	Preserve	In ROW
106	Chinese tallow tree	6	Yes	Preserve	In ROW
107	Chinese tallow tree	13	Yes	Preserve	In ROW
108	Chinese tallow tree	11	Yes	Preserve	In ROW
109	Chinese tallow tree	11	Yes	Preserve	In ROW

Tree Preservation Guidelines

The goal of tree preservation is not merely tree survival during development but maintenance of tree health and beauty for many years. Trees retained on sites that are either subject to extensive injury during construction or inadequately maintained become a liability rather than an asset. The response of individual trees depends on the amount of excavation and grading, care with which demolition is undertaken, and construction methods. Coordinating any construction activity inside the **TREE PROTECTION ZONE** can minimize these impacts.

The following recommendations will help reduce impacts to trees from development and maintain and improve their health and vitality through the clearing, grading and construction phases.

Design recommendations

1. Establish a **TREE PROTECTION ZONE** around each tree to be preserved. No grading, excavation, construction or storage of materials shall occur within this **ZONE**. No underground services including utilities, sub-drains, water or sewer shall be placed in the **TREE PROTECTION ZONE**. For design purposes, the **TREE PROTECTION ZONE** shall be a follows:
 - a. 2' behind the limit of soil remediation or grading for trees #8, 16 – 19, 20, 22 – 29, 32 and 48.
 - b. The existing property line for trees #8, 16, 17, 56 and 66.
 - c. 2' behind the limit of grading or construction for trees #57 and 58.
 - d. 14' from the trunk of trees #67 and 68.
 - e. 1' behind the limit of excavation or grading for street trees #102 – 109.
2. Any herbicides placed under paving materials must be safe for use around trees and labeled for that use.
3. As trees withdraw water from the soil, expansive soils may shrink within the root area. Therefore, foundations, footings and pavements on expansive soils near trees should be designed to withstand differential displacement.
4. Apply and maintain 4" - 6" wood chip mulch within the TPZ or tree-well area. Keep mulch 2" from the base of the tree.
5. **Tree Preservation Guidelines** prepared by the Project Arborist, which include specifications for tree protection during demolition and construction, should be included on all plans.

Pre-demolition and pre-construction treatments and recommendations

1. The demolition and construction superintendents shall meet with the Project Arborist before beginning work to review all work procedures, access routes, storage areas, and tree protection measures.
2. The **TREE PROTECTION ZONE** shall be fenced at prior to demolition, grubbing or grading. Fences shall be 6 ft. chain link or equivalent as approved by the City.
3. Structures and underground features to be removed within the **TREE PROTECTION ZONE** shall use equipment that will minimize damage to trees above and below ground, and operate from outside the **TREE PROTECTION ZONE**. Tie back branches and wrap trunks with protective materials to protect from injury as directed by the Project arborist. The Project arborist shall be on-site during all operations within the **TREE PROTECTION ZONE** to monitor demolition activity.

4. All tree work shall comply with the Migratory Bird Treaty Act as well as California Fish and Wildlife code 3503-3513 to not disturb nesting birds. To the extent feasible tree pruning and removal should be scheduled outside of the breeding season. Breeding bird surveys should be conducted prior to tree work. Qualified biologists should be involved in establishing work buffers for active nests.

Recommendations for tree protection during construction

1. Any approved grading, construction, demolition or other work within the **TREE PROTECTION ZONE** should be monitored by the Project Arborist.
2. All contractors shall conduct operations in a manner that will prevent damage to trees to be preserved.
3. Tree protection devices are to remain until all site work has been completed within the work area. Fences or other protection devices may not be relocated or removed without permission of the Project Arborist.
4. Construction trailers, traffic and storage areas must remain outside **TREE PROTECTION ZONE** at all times.
5. No excess soil, chemicals, debris, equipment or other materials shall be dumped or stored within the **TREE PROTECTION ZONE**.
6. Any root pruning required for construction purposes shall receive the prior approval of and be supervised by the Project Arborist. Roots should be cut with a saw to provide a flat and smooth cut. Removal of roots larger than 2" in diameter should be avoided.
7. If roots larger than 2" in diameter are encountered during site work and must be cut to complete the construction, the Project Arborist must be consulted to evaluate effects on the health and stability of the tree and recommend treatment.
8. All trees to be retained shall be irrigated on a schedule to be determined by the Project Arborist (every 3 to 6 weeks is typical). Each irrigation shall wet the soil within the **TREE PROTECTION ZONE** to a depth of 18-30".
9. If injury should occur to any tree during construction, it should be evaluated as soon as possible by the Project Arborist so that appropriate treatments can be applied.
10. Any additional tree pruning needed for clearance during construction must be performed by a Certified Arborist and not by construction personnel.
11. Prior to grading or trenching, trees may require root pruning outside the **TREE PROTECTION ZONE**. Any root pruning required for construction purposes shall receive the prior approval of, and be supervised by, the Project Arborist.
12. No excess soil, chemicals, debris, equipment or other materials shall be dumped or stored within the **TREE PROTECTION ZONE**.
13. Trees that accumulate a sufficient quantity of dust on their leaves, limbs and trunk as judged by the Project Arborist shall be spray-washed at the direction of the Project Arborist.

Maintenance of impacted trees

Preserved trees will experience a physical environment different from that pre-development. As a result, tree health and structural stability should be monitored. Occasional pruning, fertilization, mulch, pest management, replanting and irrigation may be required. In addition, provisions for monitoring both tree health and structural stability following construction must be made a priority. As trees age, the likelihood of failure of branches or entire trees increases; therefore, annual inspection for hazard potential is recommended.

If you have any questions regarding my observations or recommendations, please contact me.

HortScience, Inc.



Darya Barar
Certified Arborist WE-6757A

Attachments

Tree Assessment Plan

Tree Assessment Form

Tree Appraisal Value Table

Tree Appraisal Calculation Table

Tree Assessment

B Street
Hayward, CA
December 19, 2016



Tree No.	Species	Trunk Diameter (in.)	Protected Tree?	Condition 1=poor 5=excellent	Suitability for Preservation	Comments
1	Coast redwood	40	Yes	4	Moderate	Trees 1 & 2 growing in a group; typical form; vigorous growth; base partially engulfed in ivy.
2	Coast redwood	31	Yes	4	Moderate	Trees 1 & 2 growing in a group; typical form; vigorous growth.
3	Glossy privet	9,6,5,4,4,4,3,2	Yes	3	Low	Base and trunk engulfed in ivy; twig dieback.
4	Coast live oak	21	Yes	3	Low	Multiple attachments arise from 4'; base embedded in fence; attachments have included bark; good vigor; very poor form.
5	Coast redwood	33	Yes	3	Moderate	Vigorous lower foliage; top is dead.
6	California bay	7,7	Yes	3	Moderate	Codominant at base; good vigor; poor form.
7	California pepper	32	Yes	3	Low	Off-site tagged at base; overhanging property by 24'; base, trunk and canopy engulfed in ivy; dieback.
8	Coast redwood	22	Yes	3	Moderate	Off-site tag on fence; lower laterals are dead; top is healthy.
9	Coast live oak	14	Yes	3	Low	Off-site; 45 degree lean ; trunk and canopy engulfed in ivy.
10	Blue gum	79	Yes	2	Low	Off-site; base and canopy engulfed in ivy; multiple attachments arise from base; dieback.
11	English walnut	6	No	3	Low	Leaning over fence; suppressed.
12	English walnut	4	No	3	Low	Upright form; suppressed.
13	Avocado	29	Yes	3	Low	Codominant at 3'; re-joining trunks; poor form; good vigor; 2' basal wound.
14	Glossy privet	11,8	Yes	3	Low	Codominant at base; several healed wounds on trunk; twig dieback.
15	Fig	9,7,5,5	Yes	3	Low	Multiple attachments arise from base; good vigor; poor form.
16	English walnut	10	Yes	4	Moderate	Codominant at 15'; sinuous trunk; good vigor.
17	Coast live oak	14	Yes	3	Low	Sinuous trunk; 3' trunk wound ; good vigor.
18	California bay	4,2,2	Yes	2	Low	Codominant at base; little live foliage.
19	Bronze loquat	8,5	Yes	4	Moderate	Multiple attachments arise from 1'; full crown; crowed branch structure.

Tree Assessment

B Street
Hayward, CA
December 19, 2016



Tree No.	Species	Trunk Diameter (in.)	Protected Tree?	Condition 1=poor 5=excellent	Suitability for Preservation	Comments
20	Blue gum	49	Yes	2	Low	Base and canopy engulfed in ivy; multiple attachments arise from base; dieback; little live foliage.
21	Coast redwood	22	Yes	1	Low	Little live foliage; top completely dead.
22	Coast live oak	7	Yes	3	Low	Sinuuous trunk; trunk engulfed ivy; good vigor; suppressed.
23	Coast live oak	7	Yes	3	Low	Sinuuous trunk; trunk engulfed ivy; good vigor; suppressed.
24	Coast live oak	12	Yes	3	Low	Sinuuous trunk; trunk engulfed ivy; good vigor; suppressed.
25	Coast live oak	7	Yes	3	Low	Sinuuous trunk; trunk engulfed ivy; good vigor; suppressed.
26	Coast live oak	8	Yes	3	Low	Sinuuous trunk; trunk engulfed ivy; good vigor; suppressed.
27	Coast live oak	4	Yes	3	Low	Sinuuous trunk; trunk engulfed ivy; good vigor; suppressed.
28	Coast live oak	17	Yes	3	Low	Sinuuous trunk; trunk engulfed ivy; good vigor; suppressed.
29	Coast live oak	20	Yes	3	Low	Sinuuous trunk; trunk engulfed ivy; good vigor; suppressed.
30	Coast live oak	20	Yes	1	Low	Little live foliage; trunk engulfed ivy; suppressed.
31	Coast live oak	8	Yes	3	Low	Sinuuous trunk; suppressed.
32	Coast live oak	16	Yes	3	Low	Spreading form; vigorous growth; dead interior twigs.
33	Coast live oak	30	Yes	3	Low	Off-site overhanging by 19'; leaning north; vigorous growth; dead interior twigs.
34	Deodar cedar	20,19,14,1 4,14,13,11	Yes	3	Moderate	Multiple attachments arise from base; trunk engulfed in ivy; twig dieback.
35	Blackwood acacia	24	Yes	3	Moderate	Lower laterals removed; decay on trunk; elongated lower limb; full crown.
36	Blackwood acacia	9,3	Yes	3	Low	Multiple attachments arise from base; upright trunk; full crown.
37	Blackwood acacia	6	No	3	Low	Multiple attachments arise from base; upright trunk; full crown; suppressed.
38	Coast live oak	15	Yes	3	Moderate	One-sided south; vigorous growth.
39	Coast live oak	5	Yes	4	Moderate	Sinuuous trunk; good vigor; suppressed.

Tree Assessment

B Street
Hayward, CA
December 19, 2016



Tree No.	Species	Trunk Diameter (in.)	Protected Tree?	Condition 1=poor 5=excellent	Suitability for Preservation	Comments
40	Coast redwood	35	Yes	3	Low	Thin crown; some dieback; epicormic growth.
41	Coast live oak	16,6	Yes	4	Moderate	Multiple attachments arise from base; leaning south; good vigor.
42	Blackwood acacia	17	Yes	2	Low	Leaning north; dead section; trunk engulfed in ivy.
43	Blackwood acacia	7,4	Yes	3	Moderate	Multiple attachments arise from base; suppressed; vigorous growth.
44	Blackwood acacia	7,4	Yes	2	Low	Trunk engulfed in ivy; large deadwood.
45	Coast live oak	16	Yes	4	Moderate	Suppressed east; good vigor; leaning.
46	Coast live oak	26	Yes	4	Moderate	Upright form; good vigor; trunk engulfed in ivy.
47	Coast live oak	16,6	Yes	4	Moderate	Upright form; good vigor; seems on attachment; history of branch failure.
48	Coast live oak	28	Yes	4	Moderate	Good upright form; good vigor.
49	Coast live oak	10	Yes	4	Moderate	Upright form; suppressed; good vigor.
50	Incense cedar	16	Yes	3	Moderate	Codominant at 10'; good vigor; dieback.
51	Black locust	11	Yes	3	Low	Codominant at 5'; suppressed west.
52	Black locust	12,8	Yes	3	Low	Codominant at 3' and 5'; spreading form.
53	Coast live oak	23	Yes	4	Moderate	Off-site; multiple attachments arise from 10'; overhangs property by 34'; good dense crown.
54	Incense cedar	22	Yes	3	Moderate	Upright form; good vigor; some tip dieback.
55	Incense cedar	22	Yes	3	Low	Sparse crown; irregular form; included bark at attachment.
56	Coast live oak	21	Yes	4	Moderate	Off-site; overhanging property by 16'; multiple attachments arise from 8'; good vigor.
57	Coast live oak	27	Yes	4	High	Multiple attachments arise from 12'; good vigor; poor structure; narrow attachments.
58	Coast live oak	27	Yes	4	High	Codominant at 10'; good vigor; thinning crown.
59	Coast live oak	9,8	Yes	4	High	Codominant at 3'; good vigor; narrow attachments.
60	Cherry	6	No	3	Low	Leaning trunk, suppressed; twig dieback.

Tree Assessment

B Street
Hayward, CA
December 19, 2016



Tree No.	Species	Trunk Diameter (in.)	Protected Tree?	Condition 1=poor 5=excellent	Suitability for Preservation	Comments
61	Cherry	4	No	2	Low	Multiple attachments arise from 6'; suppressed; twig dieback.
62	Fig	7,7,5	Yes	3	Low	Multiple attachments arise from base; good vigor; topped; low crown.
63	Lemon	4,4	Yes	3	Low	Codominant at 3'; twig dieback in outer crown; good growth.
64	Coast redwood	28,9	Yes	3	Low	Large sucker; thin crown; chlorotic growth.
65	Camphor	27,21	Yes	3	Low	Codominant at 3'; one sided north; history of branch failure; thin crown.
66	Silver dollar gum	26	Yes	3	Moderate	Trunk engulfed in ivy; good growth.
67	Silver dollar gum	28	Yes	3	Moderate	Trunk engulfed in ivy; good growth; history of branch failure.
68	Glossy privet	4,4,4,1,1	Yes	3	Low	Multiple attachments arise from base; full dense crown.
69	Glossy privet	9	Yes	3	Low	Multiple attachments arise from base; secondary trunk topped; full dense crown.
70	Glossy privet	8	Yes	3	Low	Upright form; full crown.
71	Cherry	6	No	2	Low	Multiple attachments arise from 3'; decay; suppressed; very poor form.
72	Blackwood acacia	4	No	2	Low	In a shrub like group; thin narrow crown.
73	Blackwood acacia	4	No	2	Low	In a shrub like group; thin narrow crown.
74	Blackwood acacia	4,4,3,3,3,2	Yes	2	Low	In a shrub like group; multiple attachments arise from base; thin narrow crown.
75	Cherry	5,5,4,3,2	Yes	2	Low	Multiple attachments arise from 2'; cross trunks; decay; very poor form.
76	Grapefruit	7	No	3	Moderate	Multiple attachments arise from 1'; decay in the attachments; thick crown.
77	California pepper	28	Yes	3	Low	Poor form; history of branch failure; decay; dieback.; low branching.
78	California pepper	38,29	Yes	2	Low	Codominant at 3'; poor form; trunk complete engulfed in ivy; decay; dieback.; low branching.

Tree Assessment

B Street
Hayward, CA
December 19, 2016



Tree No.	Species	Trunk Diameter (in.)	Protected Tree?	Condition 1=poor 5=excellent	Suitability for Preservation	Comments
79	American Arborvitae	8,6	Yes	3	Low	Codominant at base; full crown; leaning north; chlorotic growth.
80	Hollywood juniper	14	Yes	3	Low	Leaning North; sinuous growth; this crown.
81	Hollywood juniper	13	Yes	3	Low	Leaning North; sinuous growth; this crown.
82	English walnut	4,4	Yes	3	Moderate	Multiple attachments arise from base; spreading form; good vigor.
83	Carolina cherry laurel	9,6,6,5	Yes	3	Low	Growing in a group of 6; multiple attachments arise from base; base and trunk engulfed in ivy; good vigor.
84	Carolina cherry laurel	7,6,2	Yes	3	Low	Growing in a group of 6; multiple attachments arise from base; base and trunk engulfed in ivy; good vigor.
85	Carolina cherry laurel	19,9	Yes	3	Low	Growing in a group of 6; multiple attachments arise from base and 3'; base and trunk engulfed in ivy; good vigor.
86	Carolina cherry laurel	11,10,10,7,5,3	Yes	3	Low	Growing in a group of 6; multiple attachments arise from base and again at 4'; base and trunk engulfed in ivy; good vigor.
87	Carolina cherry laurel	7,7,7,3,2,2	Yes	3	Low	Growing in a group of 6; multiple attachments arise from base; base and trunk engulfed in ivy; good vigor.
88	Glossy privet	8	Yes	3	Low	Multiple attachments arise from 3'; narrow attachment; upright, poor form; full crown.
89	Orange	6,3,3	Yes	3	Moderate	Low branch at 1'; full crown; decay; good vigor.
90	Giant yucca	6,5,5,4	Yes	3	Moderate	Multiple attachments arise from base; suppressed; good vigorous growth.
91	English walnut	26	Yes	3	Moderate	Spreading form; wide attachments; competing on southwestern side.
92	English walnut	38	Yes	4	High	Spreading form; wide attachments; included bark; sapsucker; full dense crown.
93	Apple	6,6,4,3,3,3,2,2,2,2	Yes	2	Low	Multiple attachments arise from base; sucker growth; poor form; decay.
94	Monterey pine	5	No	5	High	Sinuous trunk; good upright form; good young tree.

Tree Assessment

B Street
Hayward, CA
December 19, 2016



Tree No.	Species	Trunk Diameter (in.)	Protected Tree?	Condition 1=poor 5=excellent	Suitability for Preservation	Comments
95	Monterey pine	6	No	4	Moderate	Leaning trunk; good form; good young tree.
96	Monterey pine	6	No	3	Moderate	Trunk sweeps east; poor form; vigorous young tree.
97	Monterey pine	7	No	3	Moderate	Trunk sweeps east; poor form; vigorous young tree.
98	Monterey pine	6	No	4	Moderate	Codominant at 4'; vigorous young tree.
99	Avocado	4	No	4	High	Upright form; good vigorous growth; suppressed.
100	Glossy privet	6,5,4,3,2	Yes	3	Moderate	Multiple attachments arise from 3'; upright form; poor form; full crown; attachments have included bark.
101	Camphor	27	Yes	2	Low	Codominant at 7'; little live foliage; branch dieback to 4" laterals.
102	Chinese tallow tree	11	Yes	3	Moderate	Upright good form.
103	Chinese tallow tree	14	Yes	3	Moderate	Upright good form.
104	Chinese tallow tree	12	Yes	3	Moderate	Upright good form.
105	Chinese tallow tree	13	Yes	3	Moderate	Upright form; history of branch failure.
106	Chinese tallow tree	6	Yes	3	Moderate	Upright form; history of branch failure.
107	Chinese tallow tree	13	Yes	3	Moderate	Upright form; under utility lines.
108	Chinese tallow tree	11	Yes	3	Moderate	Upright form; under utility lines.
109	Chinese tallow tree	11	Yes	3	Moderate	Upright form; under utility lines.; sucker growth.

Tree Appraisal

Tree No.	Species	Trunk Diameter (in.)	Heritage Tree?	Disposition	Appraised Value	Remove for Project	Condition Removal	Preserve
1	Coast redwood	40	Yes	Remove	\$15,000	\$15,000		
2	Coast redwood	31	Yes	Remove	\$9,650	\$9,650		
3	Glossy privet	9,6,5,4,4,4,3,2	Yes	Remove	\$500	\$500		
4	Coast live oak	21	Yes	Remove	\$4,050	\$4,050		
5	Coast redwood	33	Yes	Remove	\$7,800	\$7,800		
6	California bay	7,7	No	Remove	\$1,200	\$1,200		
7	California pepper	32	Yes	Remove	\$5,100	\$5,100		
8	Coast redwood	22	Yes	Preserve	\$3,550			\$3,550
9	Coast live oak	14	Yes	Remove	\$1,850	\$1,850		
10	Blue gum	79	Yes	Remove	\$4,250		\$4,250	
11	English walnut	6	No	Remove	\$100	\$100		
12	English walnut	4	No	Remove	\$50	\$50		
13	Avocado	29	Yes	Remove	\$2,550	\$2,550		
14	Glossy privet	11,8	Yes	Remove	\$600	\$600		
15	Fig	9,7,5,5	Yes	Remove	\$2,150	\$2,150		
16	English walnut	10	Yes	Preserve	\$600			\$600
17	Coast live oak	14	Yes	Preserve	\$1,850			\$1,850
18	California bay	4,2,2	No	Preserve	\$200			\$200
19	Bronze loquat	8,5	Yes	Preserve	\$2,150			\$2,150
20	Blue gum	49	Yes	Remove	\$3,850		\$3,850	
21	Coast redwood	22	Yes	Remove	\$1,000		\$1,000	
22	Coast live oak	7	Yes	Preserve	\$700			\$700
23	Coast live oak	7	Yes	Preserve	\$700			\$700
24	Coast live oak	12	Yes	Preserve	\$1,850			\$1,850
25	Coast live oak	7	Yes	Preserve	\$700			\$700
26	Coast live oak	8	Yes	Preserve	\$850			\$850
27	Coast live oak	4	Yes	Preserve	\$250			\$250
28	Coast live oak	17	Yes	Preserve	\$3,700			\$3,700

Tree Appraisal

Tree No.	Species	Trunk Diameter (in.)	Heritage Tree?	Disposition	Appraised Value	Remove for Project	Condition Removal	Preserve
29	Coast live oak	20	Yes	Preserve	\$5,100			\$5,100
30	Coast live oak	20	Yes	Remove	\$1,000		\$1,000	
31	Coast live oak	8	Yes	Remove	\$850	\$850		
32	Coast live oak	16	Yes	Preserve	\$3,300			\$3,300
33	Coast live oak	30	Yes	Preserve	\$11,400			\$1,140
34	Deodar cedar	,19,14,14,14,13,	Yes	Remove	\$15,500	\$15,500		
35	Blackwood acacia	24	Yes	Remove	\$2,450	\$2,450		
36	Blackwood acacia	9,3	Yes	Remove	\$400	\$400		
37	Blackwood acacia	6	No	Remove	\$150	\$150		
38	Coast live oak	15	Yes	Remove	\$2,900	\$2,900		
39	Coast live oak	5	Yes	Remove	\$550	\$550		
40	Coast redwood	35	Yes	Remove	\$11,950	\$11,950		
41	Coast live oak	16,6	Yes	Remove	\$5,250	\$5,250		
42	Blackwood acacia	17	Yes	Remove	\$750		\$750	
43	Blackwood acacia	7,4	No	Remove	\$300	\$300		
44	Blackwood acacia	7,4	No	Remove	\$200		\$200	
45	Coast live oak	16	Yes	Remove	\$4,600	\$4,600		
46	Coast live oak	26	Yes	Remove	\$12,000	\$12,000		
47	Coast live oak	16,6	Yes	Remove	\$5,250	\$5,250		
48	Coast live oak	28	Yes	Preserve	\$13,900			\$1,390
49	Coast live oak	10	Yes	Remove	\$1,850	\$1,850		
50	Incense cedar	16	Yes	Remove	\$2,550	\$2,550		
51	Black locust	11	Yes	Remove	\$300	\$300		
52	Black locust	12,8	Yes	Preserve	\$500			\$500
53	Coast live oak	23	Yes	Preserve	\$9,400			\$9,400
54	Incense cedar	22	Yes	Remove	\$4,800	\$4,800		
55	Incense cedar	22	Yes	Remove	\$4,800	\$4,800		
56	Coast live oak	21	Yes	Preserve	\$10,100			\$10,100

Tree Appraisal

Tree No.	Species	Trunk Diameter (in.)	Heritage Tree?	Disposition	Appraised Value	Remove for Project	Condition Removal	Preserve
57	Coast live oak	27	Yes	Preserve	\$16,600			\$16,600
58	Coast live oak	27	Yes	Preserve	\$16,600			\$16,600
59	Coast live oak	9,8	Yes	Remove	\$2,650	\$2,650		
60	Cherry	6	No	Remove	\$350	\$350		
61	Cherry	4	No	Remove	\$100		\$100	
62	Fig	7,7,5	No	Remove	\$1,100	\$1,100		
63	Lemon	4,4	No	Remove	\$300	\$300		
64	Coast redwood	28,9	Yes	Remove	\$6,350	\$6,350		
65	Camphor	27,21	Yes	Remove	\$19,450	\$19,450		
66	Silver dollar gum	26	Yes	Preserve	\$11,250			\$11,250
67	Silver dollar gum	28	Yes	Preserve	\$13,050			\$13,050
68	Glossy privet	4,4,4,1,1	No	Remove	\$250	\$250		
69	Glossy privet	9	Yes	Remove	\$250	\$250		
70	Glossy privet	8	Yes	Remove	\$200	\$250		
71	Cherry	6	No	Remove	\$300		\$300	
72	Blackwood acacia	4	No	Remove	\$50		\$50	
73	Blackwood acacia	4	No	Remove	\$50		\$50	
74	Blackwood acacia	4,4,3,3,3,2,2	No	Remove	\$100		\$100	
75	Cherry	5,5,4,3,2	No	Remove	\$450		\$450	
76	Grapefruit	7	No	Remove	\$450	\$450		
77	California pepper	28	Yes	Remove	\$4,000	\$4,000		
78	California pepper	38,29	Yes	Remove	\$6,650		\$6,650	
79	American Arborvitae	8,6	Yes	Remove	\$1,200	\$1,200		
80	Hollywood juniper	14	Yes	Remove	\$1,400	\$1,400		
81	Hollywood juniper	13	Yes	Remove	\$1,200	\$1,200		
82	English walnut	4,4	No	Remove	\$150	\$150		
83	Carolina cherry laurel	9,6,6,5	Yes	Remove	\$2,150	\$2,150		
84	Carolina cherry laurel	7,6,2	No	Remove	\$1,100	\$1,100		

Tree Appraisal

Tree No.	Species	Trunk Diameter (in.)	Heritage Tree?	Disposition	Appraised Value	Remove for Project	Condition Removal	Preserve
85	Carolina cherry laurel	19,9	Yes	Remove	\$5,350	\$5,350		
86	Carolina cherry laurel	11,10,10,7,5,3	Yes	Remove	\$4,450	\$4,450		
87	Carolina cherry laurel	7,7,7,3,2,2	No	Remove	\$1,900	\$1,900		
88	Glossy privet	8	Yes	Remove	\$300	\$300		
89	Orange	6,3,3	No	Remove	\$950	\$950		
90	Giant yucca	6,5,5,4	No	Remove	\$1,250	\$1,250		
91	English walnut	26	Yes	Remove	\$2,850	\$2,850		
92	English walnut	38	Yes	Remove	\$8,000	\$8,000		
93	Apple	1,6,4,3,3,3,2,2,2,	No	Remove	\$1,050		\$1,050	
94	Monterey pine	5	No	Remove	\$200	\$200		
95	Monterey pine	6	No	Remove	\$200	\$200		
96	Monterey pine	6	No	Remove	\$150	\$150		
97	Monterey pine	7	No	Remove	\$200	\$200		
98	Monterey pine	6	No	Remove	\$200	\$200		
99	Avocado	4	No	Remove	\$100	\$100		
100	Glossy privet	6,5,4,3,2	No	Remove	\$400	\$400		
101	Camphor	27	Yes	Remove	\$7,300		\$7,300	
102	Chinese tallow tree	11	Yes	Preserve	\$2,050			\$2,050
103	Chinese tallow tree	14	Yes	Preserve	\$3,300			\$3,300
104	Chinese tallow tree	12	Yes	Preserve	\$2,450			\$2,450
105	Chinese tallow tree	13	Yes	Preserve	\$2,850			\$2,850
106	Chinese tallow tree	6	Yes	Preserve	\$650			\$650
107	Chinese tallow tree	13	Yes	Preserve	\$2,850			\$2,850
108	Chinese tallow tree	11	Yes	Preserve	\$2,050			\$2,050
109	Chinese tallow tree	11	Yes	Preserve	\$2,050			\$2,050
Totals					\$369,750	\$196,150	\$27,100	\$123,780

Tree Assessment

B Street
Hayward, CA

Tree No.	Species	Dia.	Cond.	Cond. Value	Location Value	Spec. Value	Rep Size	Rep Area	Rep Cost	Instal. Cost	Total Cost	Unit Tree Cost	App. Trunk Area	Trunk Area Incre.	Basic Tree Cost	App. Value	Final Value
1	Coast redwood	40	4	0.7	0.5666667	0.9	4	4.75	172.7	172.73	345.46	36.36	1149	1144.25	41950.39	14976.29	\$15,000
2	Coast redwood	31	4	0.7	0.5666667	0.9	4	4.75	172.7	172.73	345.46	36.36	739.365	734.615	27056.06	9659.014	\$9,650
3	Glossy privet	9,6,5,4,4,4,	3	0.5	0.5666667	0.3	3	3.8	172.7	172.73	345.46	45.46	124.03	120.23	5811.116	493.9448	\$500
4	Coast live oak	21	3	0.5	0.5666667	0.9	3	3.8	172.7	172.73	345.46	45.46	346.185	342.385	15910.28	4057.122	\$4,050
5	Coast redwood	33	3	0.5	0.5666667	0.9	4	4.75	172.7	172.73	345.46	36.36	835.085	830.335	30536.44	7786.792	\$7,800
6	California bay	7,7	3	0.5	0.5666667	0.7	2	2.24	172.7	172.73	345.46	77.04	76.93	74.69	6099.578	1209.75	\$1,200
7	California pepper	32	3	0.5	0.5666667	0.5	3	3.8	172.7	172.73	345.46	45.46	787.56	783.76	35975.19	5096.485	\$5,100
8	Coast redwood	22	3	0.5	0.5666667	0.9	4	4.75	172.7	172.73	345.46	36.36	379.94	375.19	13987.37	3566.779	\$3,550
9	Coast live oak	14	3	0.5	0.5666667	0.9	3	3.8	172.7	172.73	345.46	45.46	153.86	150.06	7167.188	1827.633	\$1,850
10	Blue gum	79	2	0.3	0.5666667	0.3	4	4.75	172.7	172.73	345.46	36.36	2296.965	2292.215	83690.4	4268.21	\$4,250
11	English walnut	6	3	0.5	0.5666667	0.3	3	3.8	172.7	172.73	345.46	45.46	28.26	24.46	1457.412	123.88	\$100
12	English walnut	4	3	0.5	0.5666667	0.3	3	3.8	172.7	172.73	345.46	45.46	12.56	8.76	743.6896	63.21362	\$50
13	Avocado	29	3	0.5	0.5666667	0.3	3	3.8	172.7	172.73	345.46	45.46	660.185	656.385	30184.72	2565.701	\$2,550
14	Glossy privet	11,8	3	0.5	0.5666667	0.3	3	3.8	172.7	172.73	345.46	45.46	145.225	141.425	6774.641	575.8444	\$600
15	Fig	9,7,5,5	3	0.5	0.7833333	0.5	2	2.24	172.7	172.73	345.46	77.04	141.3	139.06	11058.64	2165.651	\$2,150
16	English walnut	10	4	0.7	0.7833333	0.3	3	3.8	172.7	172.73	345.46	45.46	78.5	74.7	3741.322	615.4475	\$600
17	Coast live oak	14	3	0.5	0.5666667	0.9	3	3.8	172.7	172.73	345.46	45.46	153.86	150.06	7167.188	1827.633	\$1,850
18	California bay	4,2,2	2	0.3	0.5666667	0.7	2	2.24	172.7	172.73	345.46	77.04	18.84	16.6	1624.324	193.2946	\$200
19	Bronze loquat	8,5	4	0.7	0.7833333	0.7	2	2.24	172.7	172.73	345.46	77.04	69.865	67.625	5555.29	2132.305	\$2,150
20	Blue gum	49	2	0.3	0.7833333	0.3	4	4.75	172.7	172.73	345.46	36.36	1504.365	1499.615	54871.46	3868.438	\$3,850
21	Coast redwood	22	1	0.1	0.7833333	0.9	4	4.75	172.7	172.73	345.46	36.36	379.94	375.19	13987.37	986.1095	\$1,000
22	Coast live oak	7	3	0.5	0.7833333	0.9	3	3.8	172.7	172.73	345.46	45.46	38.465	34.665	1921.331	677.2691	\$700
23	Coast live oak	7	3	0.5	0.7833333	0.9	3	3.8	172.7	172.73	345.46	45.46	38.465	34.665	1921.331	677.2691	\$700
24	Coast live oak	12	3	0.5	0.7833333	0.9	3	3.8	172.7	172.73	345.46	45.46	113.04	109.24	5311.51	1872.307	\$1,850
25	Coast live oak	7	3	0.5	0.7833333	0.9	3	3.8	172.7	172.73	345.46	45.46	38.465	34.665	1921.331	677.2691	\$700
26	Coast live oak	8	3	0.5	0.7833333	0.9	3	3.8	172.7	172.73	345.46	45.46	50.24	46.44	2456.622	865.9594	\$850
27	Coast live oak	4	3	0.5	0.7833333	0.9	3	3.8	172.7	172.73	345.46	45.46	12.56	8.76	743.6896	262.1506	\$250
28	Coast live oak	17	3	0.5	0.7833333	0.9	3	3.8	172.7	172.73	345.46	45.46	226.865	223.065	10485.99	3696.313	\$3,700
29	Coast live oak	20	3	0.5	0.7833333	0.9	3	3.8	172.7	172.73	345.46	45.46	314	310.2	14447.15	5092.621	\$5,100
30	Coast live oak	20	1	0.1	0.7833333	0.9	3	3.8	172.7	172.73	345.46	45.46	314	310.2	14447.15	1018.524	\$1,000
31	Coast live oak	8	3	0.5	0.7833333	0.9	3	3.8	172.7	172.73	345.46	45.46	50.24	46.44	2456.622	865.9594	\$850
32	Coast live oak	16	3	0.5	0.7833333	0.9	3	3.8	172.7	172.73	345.46	45.46	200.96	197.16	9308.354	3281.195	\$3,300
33	Coast live oak	30	3	0.5	0.7833333	0.9	3	3.8	172.7	172.73	345.46	45.46	706.5	702.7	32290.2	11382.3	\$11,400
34	Deodar cedar	20,19,14,14	3	0.5	0.8333333	0.9	3	3.8	172.7	172.73	345.46	45.46	905.105	901.305	41318.79	15494.54	\$15,500
35	Blackwood acacia	24	3	0.5	0.7833333	0.3	3	3.8	172.7	172.73	345.46	45.46	452.16	448.36	20727.91	2435.529	\$2,450
36	Blackwood acacia	9,3	3	0.5	0.7833333	0.3	3	3.8	172.7	172.73	345.46	45.46	70.65	66.85	3384.461	397.6742	\$400
37	Blackwood acacia	6	3	0.5	0.7833333	0.3	3	3.8	172.7	172.73	345.46	45.46	28.26	24.46	1457.412	171.2459	\$150
38	Coast live oak	15	3	0.5	0.7833333	0.9	3	3.8	172.7	172.73	345.46	45.46	176.625	172.825	8202.085	2891.235	\$2,900
39	Coast live oak	5	4	0.7	0.7833333	0.9	3	3.8	172.7	172.73	345.46	45.46	19.625	15.825	1064.865	525.5106	\$550
40	Coast redwood	35	3	0.5	0.7833333	0.9	4	4.75	172.7	172.73	345.46	36.36	928.125	923.375	33919.38	11956.58	\$11,950
41	Coast live oak	16,6	4	0.7	0.7833333	0.9	3	3.8	172.7	172.73	345.46	45.46	229.22	225.42	10593.05	5227.672	\$5,250
42	Blackwood acacia	17	2	0.3	0.7833333	0.3	3	3.8	172.7	172.73	345.46	45.46	226.865	223.065	10485.99	739.2626	\$750
43	Blackwood acacia	7,4	3	0.5	0.7833333	0.3	3	3.8	172.7	172.73	345.46	45.46	51.025	47.225	2492.309	292.8462	\$300
44	Blackwood acacia	7,4	2	0.3	0.7833333	0.3	3	3.8	172.7	172.73	345.46	45.46	51.025	47.225	2492.309	175.7077	\$200
45	Coast live oak	16	4	0.7	0.7833333	0.9	3	3.8	172.7	172.73	345.46	45.46	200.96	197.16	9308.354	4593.673	\$4,600
46	Coast live oak	26	4	0.7	0.7833333	0.9	3	3.8	172.7	172.73	345.46	45.46	530.66	526.86	24296.52	11990.33	\$12,000
47	Coast live oak	16,6	4	0.7	0.7833333	0.9	3	3.8	172.7	172.73	345.46	45.46	229.22	225.42	10593.05	5227.672	\$5,250
48	Coast live oak	28	4	0.7	0.7833333	0.9	3	3.8	172.7	172.73	345.46	45.46	615.44	611.64	28150.61	13892.33	\$13,900
49	Coast live oak	10	4	0.7	0.7833333	0.9	3	3.8	172.7	172.73	345.46	45.46	78.5	74.7	3741.322	1846.342	\$1,850

Tree Assessment

B Street
Hayward, CA

Tree No.	Species	Dia.	Cond.	Cond. Value	Location Value	Spec. Value	Rep Size	Rep Area	Rep Cost	Instal. Cost	Total Cost	Unit Tree Cost	App. Trunk Area	Trunk Area Incre.	Basic Tree Cost	App. Value	Final Value
50	Incense cedar	16	3	0.5	0.7833333	0.7	3	3.8	172.7	172.73	345.46	45.46	200.96	197.16	9308.354	2552.04	\$2,550
51	Black locust	11	3	0.5	0.7833333	0.1	2	2.24	172.7	172.73	345.46	77.04	94.985	92.745	7490.535	293.3793	\$300
52	Black locust	12,8	3	0.5	0.7833333	0.1	2	2.24	172.7	172.73	345.46	77.04	163.28	161.04	12751.98	499.4526	\$500
53	Coast live oak	23	4	0.7	0.7833333	0.9	3	3.8	172.7	172.73	345.46	45.46	415.265	411.465	19050.66	9401.5	\$9,400
54	Incense cedar	22	3	0.5	0.7833333	0.7	3	3.8	172.7	172.73	345.46	45.46	379.94	376.14	17444.78	4782.778	\$4,800
55	Incense cedar	22	3	0.5	0.7833333	0.7	3	3.8	172.7	172.73	345.46	45.46	379.94	376.14	17444.78	4782.778	\$4,800
56	Coast live oak	21	4	0.9	0.7833333	0.9	3	3.8	172.7	172.73	345.46	45.46	346.185	342.385	15910.28	10095.07	\$10,100
57	Coast live oak	27	5	0.9	0.7833333	0.9	3	3.8	172.7	172.73	345.46	45.46	572.265	568.465	26187.88	16616.21	\$16,600
58	Coast live oak	27	5	0.9	0.7833333	0.9	3	3.8	172.7	172.73	345.46	45.46	572.265	568.465	26187.88	16616.21	\$16,600
59	Coast live oak	9,8	4	0.7	0.7833333	0.9	3	3.8	172.7	172.73	345.46	45.46	113.825	110.025	5347.197	2638.841	\$2,650
60	Cherry	6	3	0.5	0.5666667	0.5	1	2.09	172.7	172.73	345.46	82.82	28.26	26.17	2512.859	355.9884	\$350
61	Cherry	4	2	0.3	0.5666667	0.5	1	2.09	172.7	172.73	345.46	82.82	12.56	10.47	1212.585	103.0698	\$100
62	Fig	7,7,5	3	0.5	0.5666667	0.5	2	2.24	172.7	172.73	345.46	77.04	96.555	94.315	7611.488	1078.294	\$1,100
63	Lemon	4,4	3	0.5	0.5666667	0.5	2	2.24	172.7	172.73	345.46	77.04	25.12	22.88	2108.135	298.6525	\$300
64	Coast redwood	28,9	3	0.5	0.5666667	0.9	4	4.75	172.7	172.73	345.46	36.36	679.025	674.275	24862.1	6339.835	\$6,350
65	Camphor	27,21	3	0.5	0.7833333	0.7	2	2.24	172.7	172.73	345.46	77.04	918.45	916.21	70930.28	19446.72	\$19,450
66	Silver dollar gum	26	3	0.5	0.7833333	0.7	2	2.24	172.7	172.73	345.46	77.04	530.66	528.42	41054.94	11255.9	\$11,250
67	Silver dollar gum	28	3	0.5	0.7833333	0.7	2	2.24	172.7	172.73	345.46	77.04	615.44	613.2	47586.39	13046.6	\$13,050
68	Glossy privet	4,4,4,1,1	3	0.5	0.8333333	0.3	3	3.8	172.7	172.73	345.46	45.46	38.465	34.665	1921.331	240.1664	\$250
69	Glossy privet	9	3	0.5	0.5666667	0.3	3	3.8	172.7	172.73	345.46	45.46	63.585	59.785	3063.282	260.3793	\$250
70	Glossy privet	8	3	0.5	0.5666667	0.3	3	3.8	172.7	172.73	345.46	45.46	50.24	46.44	2456.626	208.8129	\$200
71	Cherry	6	2	0.3	0.8333333	0.5	1	2.09	172.7	172.73	345.46	82.82	28.26	26.17	2512.859	314.1074	\$300
72	Blackwood acacia	4	2	0.3	0.5666667	0.3	3	3.8	172.7	172.73	345.46	45.46	12.56	8.76	743.6896	37.92817	\$50
73	Blackwood acacia	4	2	0.3	0.5666667	0.3	3	3.8	172.7	172.73	345.46	45.46	12.56	8.76	743.6896	37.92817	\$50
74	Blackwood acacia	4,4,3,3,3,2,	2	0.3	0.5666667	0.3	3	3.8	172.7	172.73	345.46	45.46	39.25	35.45	1957.017	99.80787	\$100
75	Cherry	5,5,4,3,2	2	0.3	0.5666667	0.5	1	2.09	172.7	172.73	345.46	82.82	58.875	56.785	5048.394	429.1135	\$450
76	Grapefruit	7	3	0.5	0.5666667	0.5	2	2.24	172.7	172.73	345.46	77.04	38.465	36.225	3136.234	444.2998	\$450
77	California pepper	28	3	0.5	0.5666667	0.5	3	3.8	172.7	172.73	345.46	45.46	615.44	611.64	28150.61	3988.004	\$4,000
78	California pepper	38,29	2	0.3	0.5666667	0.5	3	3.8	172.7	172.73	345.46	45.46	1722.845	1719.045	78493.25	6671.926	\$6,650
79	American Arborvitae	8,6	3	0.5	0.7833333	0.5	2	2.24	172.7	172.73	345.46	77.04	78.5	76.26	6220.53	1218.187	\$1,200
80	Hollywood juniper	14	3	0.5	0.7833333	0.5	3	3.8	172.7	172.73	345.46	45.46	153.86	150.06	7167.188	1403.574	\$1,400
81	Hollywood juniper	13	3	0.5	0.7833333	0.5	3	3.8	172.7	172.73	345.46	45.46	132.665	128.865	6203.663	1214.884	\$1,200
82	English walnut	4,4	3	0.5	0.7833333	0.3	3	3.8	172.7	172.73	345.46	45.46	25.12	21.32	1314.667	154.4734	\$150
83	Carolina cherry laurel	9,6,6,5	3	0.5	0.5666667	0.7	2	2.24	172.7	172.73	345.46	77.04	139.73	137.49	10937.69	2169.308	\$2,150
84	Carolina cherry laurel	7,6,2	3	0.5	0.5666667	0.7	2	2.24	172.7	172.73	345.46	77.04	69.865	67.625	5555.29	1101.799	\$1,100
85	Carolina cherry laurel	19,9	3	0.5	0.5666667	0.7	2	2.24	172.7	172.73	345.46	77.04	346.97	344.73	26903.46	5335.853	\$5,350
86	Carolina cherry laurel	11,10,10,7,	3	0.5	0.5666667	0.7	2	2.24	172.7	172.73	345.46	77.04	290.45	288.21	22549.16	4472.25	\$4,450
87	Carolina cherry laurel	7,7,7,3,2,2	3	0.5	0.5666667	0.7	2	2.24	172.7	172.73	345.46	77.04	122.46	120.22	9607.209	1905.43	\$1,900
88	Glossy privet	8	3	0.5	0.7833333	0.3	3	3.8	172.7	172.73	345.46	45.46	50.24	46.44	2456.622	288.6531	\$300
89	Orange	6,3,3	3	0.5	0.7833333	0.7	2	2.24	172.7	172.73	345.46	77.04	42.39	40.15	3438.616	942.7539	\$950
90	Giant yucca	6,5,5,4	3	0.5	0.7833333	0.5	2	2.24	172.7	172.73	345.46	77.04	80.07	77.83	6341.483	1241.874	\$1,250
91	English walnut	26	3	0.5	0.7833333	0.3	3	3.8	172.7	172.73	345.46	45.46	530.66	526.86	24296.52	2854.841	\$2,850
92	English walnut	38	4	0.7	0.7833333	0.3	3	3.8	172.7	172.73	345.46	45.46	1062.66	1058.86	48481.24	7975.163	\$8,000
93	Apple	6,6,4,3,3,3,	2	0.3	0.7833333	0.7	1	2.09	172.7	172.73	345.46	82.82	76.145	74.055	6478.695	1065.745	\$1,050
94	Monterey pine	5	5	0.9	0.7833333	0.3	4	4.75	172.7	172.73	345.46	36.36	19.625	14.875	886.315	187.4556	\$200
95	Monterey pine	6	4	0.7	0.7833333	0.3	4	4.75	172.7	172.73	345.46	36.36	28.26	23.51	1200.284	197.4467	\$200
96	Monterey pine	6	3	0.5	0.7833333	0.3	4	4.75	172.7	172.73	345.46	36.36	28.26	23.51	1200.284	141.0333	\$150
97	Monterey pine	7	3	0.5	0.7833333	0.3	4	4.75	172.7	172.73	345.46	36.36	38.465	33.715	1571.337	184.6321	\$200
98	Monterey pine	6	4	0.7	0.7833333	0.3	4	4.75	172.7	172.73	345.46	36.36	28.26	23.51	1200.284	197.4467	\$200

Tree Assessment

B Street
Hayward, CA

Tree No.	Species	Dia.	Cond.	Cond. Value	Location Value	Spec. Value	Rep Size	Rep Area	Rep Cost	Instal. Cost	Total Cost	Unit Tree Cost	App. Trunk Area	Trunk Area Incre.	Basic Tree Cost	App. Value	Final Value
99	Avocado	4	4	0.7	0.7833333	0.3	3	3.8	172.7	172.73	345.46	45.46	12.56	8.76	743.6896	122.3369	\$100
100	Glossy privet	6,5,4,3,2	3	0.5	0.7833333	0.3	3	3.8	172.7	172.73	345.46	45.46	67.51	63.71	3241.717	380.9017	\$400
101	Camphor	27	2	0.3	0.7833333	0.7	2	2.24	172.7	172.73	345.46	77.04	572.265	570.025	44260.19	7280.801	\$7,300
102	Chinese tallow tree	11	3	0.5	0.7833333	0.7	2	2.24	172.7	172.73	345.46	77.04	94.985	92.745	7490.535	2053.655	\$2,050
103	Chinese tallow tree	14	3	0.5	0.7833333	0.7	2	2.24	172.7	172.73	345.46	77.04	153.86	151.62	12026.26	3297.201	\$3,300
104	Chinese tallow tree	12	3	0.5	0.7833333	0.7	2	2.24	172.7	172.73	345.46	77.04	113.04	110.8	8881.492	2435.009	\$2,450
105	Chinese tallow tree	13	3	0.5	0.7833333	0.7	2	2.24	172.7	172.73	345.46	77.04	132.665	130.425	10393.4	2849.524	\$2,850
106	Chinese tallow tree	6	3	0.5	0.7833333	0.7	2	2.24	172.7	172.73	345.46	77.04	28.26	26.02	2350.041	644.3029	\$650
107	Chinese tallow tree	13	3	0.5	0.7833333	0.7	2	2.24	172.7	172.73	345.46	77.04	132.665	130.425	10393.4	2849.524	\$2,850
108	Chinese tallow tree	11	3	0.5	0.7833333	0.7	2	2.24	172.7	172.73	345.46	77.04	94.985	92.745	7490.535	2053.655	\$2,050
109	Chinese tallow tree	11	3	0.5	0.7833333	0.7	2	2.24	172.7	172.73	345.46	77.04	94.985	92.745	7490.535	2053.655	\$2,050
Total																	\$369,750

Appendix B

Preliminary Geotechnical Assessment



B STREET PROJECT
HAYWARD, CALIFORNIA

PRELIMINARY GEOTECHNICAL ASSESSMENT

Submitted to

Mr. James Wilson
Dutra Land & Consulting Services, Inc.
43430 Mission Blvd, Suite 210
Fremont, CA 94539

Prepared by

ENGEO Incorporated

January 13, 2017

Project No.

13599.000.000



Project No.
13599.000.000

January 13, 2017

Mr. James Wilson
 Dutra Land & Consulting Services, Inc.
 43430 Mission Blvd., Suite 210
 Fremont, CA 94539

Subject: B Street Project
 Hayward, California

PRELIMINARY GEOTECHNICAL ASSESSMENT

Dear Mr. Wilson:

With your authorization, we performed a preliminary geotechnical assessment for the properties located at the corner of 4th Street and B Street in Hayward, California, consisting of Accessor Parcel Numbers 427-36-33-5, 427-36-33-6, 427-36-33-7, 427-36-85-1, and 427-36-55-19. This report presents our geotechnical observations, as well as our preliminary conclusions and recommendations. We have also provided preliminary site grading, drainage, and foundation recommendations for use during land planning.

Based upon our initial assessment, it is our opinion that the proposed residential development is feasible from a geotechnical standpoint. Design-level exploration(s) should be conducted prior to site development once more detailed land plans have been prepared.

We are pleased to have been of service on this project and are prepared to consult further with you and your design team as the project progresses. If you have any questions regarding the contents of this report, please do not hesitate to contact us.

Sincerely,

ENGEEO Incorporated

Randy Hildebrant, GE



Josef J. Tootle, GE



TABLE OF CONTENTS

Letter of Transmittal

1.0	INTRODUCTION	1
1.1	PURPOSE AND SCOPE	1
1.2	PROJECT LOCATION	1
1.3	PROJECT DESCRIPTION	1
1.4	SITE BACKGROUND	1
2.0	SITE GEOLOGY AND SEISMICITY	2
2.1	REGIONAL AND SITE GEOLOGY	2
2.2	SITE SEISMICITY	2
2.3	SURFACE CONDITIONS	2
2.4	FIELD EXPLORATION	3
2.5	LABORATORY TESTING	3
2.6	SUBSURFACE CONDITIONS	3
2.7	GROUNDWATER CONDITIONS	3
3.0	DISCUSSION AND PRELIMINARY CONCLUSIONS	4
3.1	EXPANSIVE SOILS	4
3.2	EXISTING FILL AND DISTURBED SOIS	4
3.3	SEISMIC HAZARDS	4
3.3.1	Ground Rupture	5
3.3.2	Ground Shaking	5
3.3.3	Lurching	5
3.3.4	Liquefaction/Clay Soil Softening	5
3.3.5	Seismic-Induced Settlement Analyses	6
3.3.6	Lateral Spreading and Earthquake-Induced Landsliding	7
3.3.7	Seismic Slope Stability	7
4.0	PRELIMINARY RECOMMENDATIONS	8
4.1	GRADING	8
4.1.1	Demolition and Stripping	8
4.1.2	Existing Fill and Disturbed Soil	9
4.1.3	Selection of Materials	9
4.1.4	Differential Fill Thickness	9
4.1.5	Fill Placement	9
4.1.6	Surface Venting Mitigation	10
5.0	SLOPE SETBACK RECOMMENDATIONS	10
5.1	PRELIMINARY BUILDING CODE SEISMIC DESIGN	10
5.2	PRELIMINARY FOUNDATION DESIGN	11
5.2.1	Post-Tensioned Mat Foundation Design	11
5.3	PRELIMINARY PAVEMENT DESIGN	11
5.4	DRAINAGE	11
5.5	STORMWATER BIORETENTION AREAS	12
6.0	FUTURE STUDIES	13
7.0	LIMITATIONS AND UNIFORMITY OF CONDITIONS	13

TABLE OF CONTENTS (Continued)**FIGURES**

- Figure 1 - Vicinity Map
- Figure 2 - Site Plan
- Figure 3 - Regional Geologic Map
- Figure 4 - Earthquake Zones of Required Investigation
- Figure 5 - Regional Faulting and Seismicity Map

APPENDIX A – Cone Penetration Tests (CPTs)**APPENDIX B** – Laboratory Test Data**APPENDIX C** – Liquefaction Analysis**APPENDIX D** – Slope Stability Analysis

1.0 INTRODUCTION

1.1 PURPOSE AND SCOPE

The purpose of this preliminary geotechnical exploration, as described in our proposal dated May 9, 2016 and revised December 5, 2016, is to provide an assessment of the potential geotechnical concerns associated with the use of the site for a residential development. The scope of our services included a site visit, a review of published geologic maps, review of readily available geotechnical and/or environmental reports for the site, advancing five Cone Penetration Tests (CPTs) ranging up to 45½ feet deep, and preparation of this report identifying potential geotechnical hazards.

This report was prepared for the exclusive use of our client and their consultants for evaluation of this project. In the event that any changes are made in the character, design or layout of the development, we must be contacted to review the preliminary conclusions and recommendations contained in this report to determine whether modifications are necessary. This document may not be reproduced in whole or in part by any means whatsoever, nor may it be quoted or excerpted without our express written consent.

1.2 PROJECT LOCATION

The project area is located in Hayward, California (Figure 1) and consists of two parcels, one north of 4th Street and one south of 4th Street (Figure 2). The northern parcel is bounded by 4th Street to the west, B Street to the south, Chestnut Street to the east, and San Lorenzo Creek to the north, and totals about 3.44 acres. Parcels in the northwest and southeast corners of the bounded area are not included in the project area. The southeast corner parcel is currently occupied with residential detached homes. The southern creek bank on the north side of the project site ranges in height between 21 and 26 feet and is approximately inclined at a 1½:1 to 2:1 (horizontal:vertical). The southern parcel is located at 22626 4th Street and is about 1.6 acres in area.

1.3 PROJECT DESCRIPTION

At this time, no conceptual or improvement plans have been developed; however, we anticipate two- to three-story buildings of wood-framed construction with light to moderately light building loads and grading to consist of minor cuts and fills on the order of 2 to 3 feet.

1.4 SITE BACKGROUND

Based on a preliminary review of historical aerial photographs, site grades remained relatively unchanged; however, topographic maps dated 1939 and prior, show San Lorenzo Creek with a different alignment. It does not appear that the creek varied in location adjacent to the project site. In historic aerial photographs, additional structures are shown throughout both parcels, including residential detached homes and portions of the northern parcel being used as orchards.

2.0 SITE GEOLOGY AND SEISMICITY

2.1 REGIONAL AND SITE GEOLOGY

The region is within the Coast Range Province of California, an area dominated by northwest-trending geologic features such as folds and faults. More specifically, the subject site is located on alluvial deposits near the eastern margin of the San Francisco Bay. The San Francisco Bay is located in a fault bound, elongated structural trough that has been filled with a sequence of Quaternary age sedimentary deposits derived from the surrounding Coast Ranges.

Based on mapping by Helley and Graymer (1997), the deposits underlying the subject site comprise Holocene-aged alluvial fan deposits (Figure 3). Helley and Graymer describe the deposits as brown or tan, medium dense to dense, gravely sand or sandy gravel that generally grades upward, to sandy or silty clay.

2.2 SITE SEISMICITY

The San Francisco Bay Area contains numerous active faults. Figure 5 shows the approximate location of active and potentially active faults and significant historic earthquakes mapped within the San Francisco Bay Region. An active fault is defined by the State as one that has had surface displacement within Holocene time (about the last 11,000 years). Based on the 2010 USGS Quaternary Fault and Fold Database (QFFD), the nearest active fault is the Hayward fault located approximately 0.5 miles southwest of the site. Other active faults located near the site include the Calaveras fault, located approximately 7.8 miles to the east-northeast of the site, and the San Andreas fault, located approximately 19.1 miles to the west-southwest.

The Uniform California Earthquake Rupture Forecast (UCERF3, 2013) evaluated the 30-year probability of a Moment Magnitude 6.7 or greater earthquake occurring on the known active fault systems in the Bay Area. The UCERF3 generated an overall probability of 72 percent for the San Francisco Region as a whole, a probability of 14.3 percent for the Hayward fault, 7.4 percent for the Calaveras fault, and 6.4 percent for the northern section of the San Andreas fault.

The site is not located within a currently designated Alquist-Priolo Earthquake Fault Zone (Figure 4) and no known surface expression of active faults is believed to exist within the site.

2.3 SURFACE CONDITIONS

The site is generally level and the majority of the site contains grass, shrubs, and trees at the ground surface. The parcel located on the southern side of B Street contains paved areas and concrete pads from demolished structures. In the parcel north of B Street are several abandoned structures as well as foundations and concrete pads from demolished structures. A well was observed in the north-central portion of the site near a site where structures had been demolished (Figure 2). The well is approximately 4 feet in diameter and may be 20 feet or more in depth. As previously noted, the northern boundary of the project site consists of an existing creek. At the time of our field exploration, we observed significant flow in the creek. The banks of the creek are relatively steep, approximately inclined at a slope of 1½:1 to 2:1 (horizontal:vertical), and the banks consist of loose soil and vegetation. Some surficial slumping and erosion of the creek bank was observed near the eastern edge of the site.

2.4 FIELD EXPLORATION

Our field exploration included advancing five Cone Penetration Tests (CPTs) at various locations on the site as shown in Figure 2. We performed our field exploration on December 23, 2016. The location of our explorations are approximate and were estimated by pacing from features shown on the site plan; they should be considered accurate only to the degree implied by the method used.

We retained a CPT rig to push the cone penetrometer to a maximum depth of about 46½ feet. The CPT has a 20-ton compression-type cone with a 15-square-centimeter (cm²) base area, an apex angle of 60 degrees, and a friction sleeve with a surface area of 225 cm². The cone, connected with a series of rods, is pushed into the ground at a constant rate. Cone readings are taken at approximately 5-cm intervals with a penetration rate of 2 cm per second in accordance with ASTM D-3441. Measurements include the tip resistance to penetration of the cone (Qc), the resistance of the surface sleeve (Fs), and pore pressure (U) (Robertson and Campanella, 1988). CPT logs are presented in Appendix A.

Soil samples were retrieved using the CPT driven sampler at select locations. Near surface samples were also collected using hand sampling.

2.5 LABORATORY TESTING

We performed laboratory tests on selected soil samples to determine the plasticity index, gradation, and moisture content of the samples submitted. Individual test results are presented in Appendix B.

2.6 SUBSURFACE CONDITIONS

Our exploration CPTs encountered varying strata of alluvium, including stiff to very stiff lean clay and sandy lean clay, silt, and medium dense to dense silty and clayey sand. The near-surface soil consisted of a moderately plastic clay ranging in plasticity index between 18 and 19. CPT-1 through CPT-3 generally encountered a very dense or very hard layer approximately between 15 and 20 feet below the ground surface. CPT-5 encountered generally fine-grained soil in the upper 29 feet. We compared the laboratory testing of select soil samples and when classified under the Unified Classification System, the material estimated to be sandy silt or silty sand by the CPT is considered a Sandy Lean Clay. Generally, it appears that the CPT generally estimated lower fines content than the tested samples. CPT-1 through CPT-4 encountered refusal at depths ranging between 22 and 36 feet for the northern parcel and 46 feet in the southern parcel for CPT-5.

The CPT logs include the specific subsurface conditions at the location of the probes. We include our exploration logs in Appendix A.

2.7 GROUNDWATER CONDITIONS

During our field exploration, pore pressure dissipation tests were performed at CPT-1 and CPT-5, indicating a depth to groundwater of approximately 24 feet and 11 feet, respectively. This is consistent with environmental monitoring wells in the area. Fluctuations in the level of groundwater may occur due to variations in rainfall, tidal influences, irrigation practice, and other factors.

3.0 DISCUSSION AND PRELIMINARY CONCLUSIONS

Based upon this preliminary study, it is our opinion that the project site is feasible for the proposed residential development from a geotechnical standpoint provided the preliminary recommendations contained in this report and future design-level geotechnical studies are incorporated into the development plans. A site-specific geotechnical exploration should be performed as part of the design process. The exploration would include borings and laboratory soil testing to provide data for preparation of specific recommendations regarding grading, foundation design, and drainage for the proposed development. The exploration will also allow for more detailed evaluations of the geotechnical issues discussed below and afford the opportunity to provide recommendations regarding techniques and procedures to be implemented during construction to mitigate potential geotechnical/geological hazards.

Based upon our field exploration and review of readily available published maps and reports for the site, the main geotechnical concerns for the proposed site development include: (1) potentially liquefiable soil, (2) Slope Stability, (3) the presence of potentially expansive near-surface soils, and (4) the presence of undocumented fills or buried structures and disturbed soil. These items and other geotechnical issues are discussed in the following sections of this report.

3.1 EXPANSIVE SOILS

We observed moderately expansive clay near the surface of the site. Successful performance of structures on expansive soils requires special attention during construction. Expansive soils change in volume with changes in moisture. These soils can shrink or swell and cause heaving and cracking of slabs-on-grade, pavements, and structures founded on shallow foundations. It is imperative that exposed soils be kept moist prior to placement of concrete for foundation construction.

We provide preliminary grading recommendations for compaction of clay soil at the site. The purpose of these preliminary recommendations is to reduce the swell potential of the clay by compacting the soil at a high moisture content and controlling the amount of compaction. Preliminary earthwork recommendations are presented in Section 4.0 of this report.

3.2 EXISTING FILL AND DISTURBED SOIS

We could not readily determine the presence of fill due to our exploration type; however, minor fills likely exist associated with the existing and former structures and associated underground facilities. These fills will likely require subexcavation and placement as engineered fill. In addition to existing fill, the upper two to three feet may be highly disturbed due to previous use as an orchard. The extent and quality of existing fills and disturbed soil should be evaluated, and potential mitigation measures recommended, at the time of design-level study.

The presence of existing fill can lead to differential foundation movement due to the unknown density of the fill and due to differences in material properties for structures that span from the fill to native materials. Mitigation can include removal and recompaction of the fill.

3.3 SEISMIC HAZARDS

Potential seismic hazards resulting from a nearby moderate to major earthquake can generally be classified as primary and secondary. The primary effect is ground rupture, also called surface

faulting. The common secondary seismic hazards include ground shaking, ground lurching, soil liquefaction, and lateral spreading. These hazards are discussed in the following sections.

Based on topographic and lithologic data, regional subsidence or uplift, tsunamis, landslides and seiches is considered low at the site.

3.3.1 Ground Rupture

The site is not located within a State of California Earthquake Fault Hazard Zone (1982) as shown in Figure 4. Therefore, since no known active faults cross the site, it is our opinion that ground rupture is not likely to occur at the site.

3.3.2 Ground Shaking

An earthquake of moderate to high magnitude generated within the San Francisco Bay Region, similar to those that have occurred in the past, could cause considerable ground shaking at the site. To mitigate the shaking effects, all structures should be designed using sound engineering judgment and the latest California Building Code (CBC) requirements as a minimum. Seismic design provisions of current building codes generally prescribe minimum lateral forces, applied statically to the structure, combined with the gravity forces of dead and live loads. The code-prescribed lateral forces are generally substantially smaller than the expected peak forces that would be associated with a major earthquake. Therefore, structures should be able to: (1) resist minor earthquakes without damage, (2) resist moderate earthquakes without structural damage but with some nonstructural damage, and (3) resist major earthquakes without collapse but with some structural as well as nonstructural damage. Conformance to the current building code recommendations does not constitute any kind of guarantee that significant structural damage would not occur in the event of a maximum magnitude earthquake; however, it is reasonable to expect that a well-designed and well-constructed structure will not collapse or cause loss of life in a major earthquake (SEAOC, 1996).

3.3.3 Lurching

Ground lurching is a result of the rolling motion imparted to the ground surface during energy released by an earthquake. Such rolling motion can cause ground cracks to form. The potential for the formation of these cracks is considered greater at contacts between deep alluvium and bedrock. Such an occurrence is possible at the site, as in other geologically similar locations in the Bay Area, but the offset or strain is expected to be low to negligible.

3.3.4 Liquefaction/Clay Soil Softening

The site is located within a State of California Seismic Hazard Zone (CGS, 2003) for areas that may be susceptible to liquefaction (Figure 4). Soil liquefaction results from loss of strength during cyclic loading, such as imposed by earthquakes. Soils most susceptible to liquefaction are clean, loose, saturated, uniformly graded, fine-grained sands. Empirical evidence indicates that loose to medium dense gravels, silty sands, low-plasticity silts, and some low-plasticity clays are also potentially liquefiable.

As described previously, layers of sandy soil below the groundwater table were encountered in our exploration locations. We performed a detailed liquefaction potential analysis of the CPT soundings to estimate liquefaction potential using the computer software CLiq Version 2.0 developed by GeoLogismiki. The procedure used in the software is based on the procedure by

Boulanger and Idriss (2014). The Cyclic Stress Ratio (CSR) was estimated for a Peak Ground Acceleration (PGA) value of 0.94 g as outlined in the ASCE 7-10 and moment magnitude of 7.3. We evaluated the liquefaction potential for the soils encountered below the assumed water table. The analysis showed that a layer of soil between 20 and 31 feet in CPT-1 was liquefiable, however, a sample was recovered between 20 and 24 feet and indicated the material to be a Sandy Lean Clay with a Plasticity Index of 19 and generally considered to have a low potential for liquefaction. The analysis also indicated a layer of soil between 20 and 24 feet in CPT-3 was potentially liquefiable, laboratory testing of the soil retrieved from this layer yielded about 29 percent fines which indicates a silty or clayey sand and potentially liquefiable. Analysis of CPT-5 shows various layers of potentially liquefiable material; however, soil samples were not retrieved at this location.

3.3.5 Seismic-Induced Settlement Analyses

Seismically induced settlement can be generally subdivided into two categories for granular soils: (1) settlement as a result of liquefaction of saturated or nearly saturated soils and (2) dynamic densification of non-saturated soils. Research has also shown that low-expansive cohesive soils can also undergo post-seismic settlement.

3.3.5.1 Liquefaction Settlement and Cyclic Softening

Deformation of the ground surface is a common result of liquefaction. Vertical settlement may result from densification of the deposit or volume loss from venting to the ground surface. Densification occurs as excess pore pressures dissipate, resulting as vertical settlement at the ground surface. In addition to the above analysis, we also evaluated the capping effect of any overlying non-liquefiable soils. In order for liquefaction-induced ground failure to occur, the pore water pressure generated within the liquefied strata must exert a sufficient enough force to break through the overlying soil and vent to the surface resulting in sand boils or fissures.

In 1985, Ishihara presented preliminary empirical criteria to assess the potential for ground surface disruption at liquefiable sites based on the relationship between thickness of liquefiable sediments and thickness of overlying non-liquefiable soil. A more recent study by Youd and Garris (1995) expanded on the work of Ishihara to include data from over 308 exploratory borings, 15 different earthquakes, and several ranges of recorded peak ground acceleration. The previous study included figures for PGAs up to 0.78g. When using the figure for PGAs up to 0.78g, the potentially liquefiable soils may be sufficiently capped by a sufficient thickness of non-liquefiable soils to prevent venting; however, the PGA required by the CBC to evaluate liquefaction and its consequences is mapped as 0.94g at the project site.

Based on the above studies, the potentially liquefiable soils may not be sufficiently capped by a sufficient thickness of non-liquefiable soils to prevent venting. The settlement estimates provided below assume that the potential surface venting has been mitigated as recommended in Section 4.1.6. This hazard should be further evaluated during a design-level study with additional borings and laboratory testing.

Clay-like (cohesive) soils can also develop pore pressures during cyclic loading, but generally do not reach zero effective stress and are typically considered non-liquefiable (Robertson 2009). However, clay-like soils can deform during cyclic earthquake loading and experience volumetric strains and post-earthquake reconsolidation. The volumetric strains for clay-like soils are

generally small compared to cohesionless soils (sand-like), since clay-like soils often retain some original soil structure. Clay reconsolidation was estimated using the program Cliq.

We calculated potential liquefaction-induced settlement estimates using the program Cliq. The procedures used in Cliq are based on the methods published by Zhang, G., Robertson, P.K., and Brachman, R. (2002). Since some of the granular materials were characterized as medium dense and potentially liquefiable and some fine-grained soil is susceptible to soil softening, we estimate the total liquefaction-induced settlements across the site to be less than 3 inches. Differential settlement during a liquefaction event is expected to be less than 1½ inch (SCEC, 1999).

3.3.5.2 Dynamic Densification Settlement

Densification of loose granular soils above the water table can cause settlement of the ground surface due to earthquake-induced vibrations. We calculated potential liquefaction-induced settlement estimates using the program Cliq. The procedures used in Cliq are based on the methods published by Zhang, G., Robertson, P.K., and Brachman, R. (2002). Our analysis indicates up to approximately 1 inch of settlement may occur due to dynamic densification at the site. Differential settlement is expected to be less than ½ inch (SCEC, 1999).

3.3.6 Lateral Spreading and Earthquake-Induced Landsliding

Lateral spreading and earthquake-induced landsliding involve lateral ground movements caused by seismic shaking. These lateral ground movements are often associated with a weakening or failure of an embankment or soil mass overlying a layer of liquefied sands or weak soils. Due to creek bank creating a free-face and potentially liquefiable material, there is a potential for lateral spreading at the site. We have performed preliminary slope stability analysis presented in the following section to estimate the stability of the creek bank during long term and seismic conditions.

3.3.7 Seismic Slope Stability

3.3.7.1 Estimation of Shear Strength

For the purposes of slope stability evaluation, we divided the alluvium into various layers. Shear strength parameters for the alluvial deposits were estimated from data published by Bjerrum and Simons (1960), Stark and Eid (1997), and correlations with the CPT data. Residual Undrained Shear strength of the liquefiable soil was estimated using Idriss and Boulanger (2008).

TABLE 3.3.7.1-1: Summary of Shear Strength Parameters

MATERIAL	STATIC SHEAR STRENGTH PARAMETERS		SEISMIC STRENGTH PARAMETERS	
	FRICITION ANGLE (DEG)	COHESION (PSF)	FRICITION ANGLE (DEG)	COHESION (PSF)
Upper Alluvium	28	0	28	150
Upper Very Dense/Hard Layer	40	0	40	0
Lower Very Dense/Hard Layer	40	0	40	0
Liquefiable Soil	--	--	0	650

3.3.7.2 [Methods of Analysis](#)

We performed two-dimensional limit-equilibrium slope stability analyses with the computer slope stability software Slide Version 7.0 using Spencer's method (Spencer, 1967). We performed slope stability analyses on a generalized cross-section representing a typical creek bank section.

Special Publication 117A "Guidelines for Evaluating and Mitigating Seismic Hazards in California" (CGS, 2008a), is currently used in practice to evaluate seismic stability of slopes in California. In Note 48, which is used for Public Schools, Hospitals, and Essential Services Buildings, it advises the procedure recommended in SP117A in addition to using a design-level ground motion based on geometric mean and without risk coefficient (i.e. $PGA_M/1.5$). PGA_M was determined to be 0.94g in accordance to the 2016 CBC and ASCE 7-10. The PGA_M was then divided by 1.5 to yield a design-level PGA of 0.63g. SP117A states that slopes that have a pseudo-static factor of safety greater than 1.0 using a seismic coefficient derived from the screening analysis procedure of Stewart and others (2003) can be considered stable. The pseudo-static coefficient used was determined to be 0.42PGA (0.26g) based on 15 cm threshold of displacement as recommended by Stewart and others (2003).

3.3.7.3 [Slope Stability Analyses Results](#)

Based on our analysis presented in Appendix D with a recommended set-back of 3:1 (horizontal:vertical) from the toe of slope projecting upward to the ground surface, the static factor of safety was estimated to be 1.8 and the seismic pseudo-static factor of safety to be about 1.0. We provide preliminary slope setback recommendations in Section 5.0.

4.0 PRELIMINARY RECOMMENDATIONS

4.1 GRADING

The following preliminary recommendations are for initial land planning and preliminary estimating purposes. Final recommendations regarding site grading and foundation construction will be provided after additional site-specific exploration has been undertaken.

4.1.1 [Demolition and Stripping](#)

Site development should commence with the removal of buried structures, including abandoned utilities and septic tanks and their leach fields, if any exist. All debris should be removed from any location to be graded, from areas to receive fill or structures, or those areas to serve as borrow. The depth of removal of such materials should be determined by the Geotechnical Engineer in the field at the time of grading.

Existing vegetation and pavements (asphalt concrete/concrete and underlying aggregate base) should be removed from areas to receive fill, or structures, or those areas to serve for borrow. Tree roots should be removed down to a depth of at least 3 feet below existing grade. The actual depth of tree root removal should be determined by the Geotechnical Engineer's representative in the field. Subject to approval by the Landscape Architect, strippings and organically contaminated soils can be used in landscape areas. Otherwise, such soils should be removed from the project site. Any topsoil that will be retained for future use in landscape areas should be stockpiled in areas where it will not interfere with grading operations.

All excavations from demolition and stripping below design grades should be cleaned to a firm undisturbed soil surface determined by the Geotechnical Engineer. This surface should then be scarified, moisture conditioned, and backfilled with compacted engineered fill. The requirements for backfill materials and placement operations are the same as for engineered fill.

No loose or uncontrolled backfilling of depressions resulting from demolition and stripping is permitted.

4.1.2 Existing Fill and Disturbed Soil

All existing fill and soft material should be excavated to firm native soils. Excavated material may be used as fill material if it meets the requirements of Section 4.1.3. For planning purposes, the upper 3 feet should be anticipated to be mitigated.

4.1.3 Selection of Materials

With the exception of construction debris (wood, brick, asphalt, concrete, metal, etc.), trees, organically contaminated materials (soil which contains more than 3 percent organic content by weight), and environmentally impacted soils (if any), we anticipate the site soils are suitable for use as engineered fill provided they are broken down to 6 inches or less in size. Other materials and debris, including trees with their root balls, should be removed from the project site.

Imported fill materials should meet the above requirements and have a plasticity index less than the on-site soils. ENGEO should sample and test proposed imported fill materials at least 72 hours prior to delivery to the site.

4.1.4 Differential Fill Thickness

Cuts associated with removal of buried structures, foundations, tanks, or undocumented fills could result in differential fill thickness conditions. For subexcavation activities that create a differential fill thickness across a building footprint, mitigation to achieve a similar fill thickness across the pad is beneficial for the performance of a shallow foundation system. We recommend that a differential fill thickness of up to 10 feet is acceptable across a building footprint. For a differential fill thickness exceeding 10 feet across a footprint, we recommend performing subexcavation activities to bring this vertical distance to within the 10-foot tolerance and that the material be replaced as engineered fill. As a minimum, the subexcavation area should include the entire structure footprint plus 5 feet beyond the edges of the building footprint.

4.1.5 Fill Placement

For land planning and cost estimating purposes, the following compaction control requirements should be anticipated for general fill areas:

Test Procedures:	ASTM D-1557.
Required Moisture Content:	Not less than 3 percentage points above optimum moisture content.
Minimum Relative Compaction:	90 percent.

Relative compaction refers to the in-place dry density of soil expressed as a percentage of the maximum dry density of the same material.

Additional compaction requirements may be required for deeper fills and retaining wall backfill. These additional requirements will be developed during our detailed exploration.

4.1.6 Surface Venting Mitigation

As previously stated, there may not be a sufficient amount of non-liquefiable soil overlying potentially liquefiable soil to prevent surface venting and volume loss. A potential mitigation option to strengthen the overlying soil is to provide 6-foot-thick reinforced soil pad below buildings. If this hazard is confirmed during project design, geogrid reinforcement should biaxial geogrid placed at 6, 4, and 2 foot depth, alternating the placement direction of the geogrid. As an alternative, the building foundation may be designed to accommodate additional differential settlement due to volume loss.

5.0 SLOPE SETBACK RECOMMENDATIONS

Based on the preliminary stability analysis, we recommend planning improvements a minimum 3:1 (horizontal:vertical) line of projection from the toe of the creek bank to the top of the bank. We recommend non-habitable improvements such as streets and non-critical utilities be located nearer to the creek bank to create additional space between the habitable structures and the creek bank.

The purpose of these setbacks is to address potential for instability and erosion of the creek banks. It is anticipated that surficial failures may adversely impact the area within the recommended setback zone. Maintenance and/or repair within this area may be necessary over the long term.

5.1 PRELIMINARY BUILDING CODE SEISMIC DESIGN

We provide the 2016 California Building Code (CBC) seismic parameters in Table 5.1-1 below.

TABLE 5.1-1: 2016 CBC Seismic Design Parameters

PARAMETER	VALUE
Site Class	D
Mapped MCE_R Spectral Response Acceleration at Short Periods, S_S (g)	2.44
Mapped MCE_R Spectral Response Acceleration at 1-second Period, S_1 (g)	1.02
Site Coefficient, F_A	1.00
Site Coefficient, F_V	1.50
MCE_R Spectral Response Acceleration at Short Periods, S_{MS} (g)	2.44
MCE_R Spectral Response Acceleration at 1-second Period, S_{M1} (g)	1.53
Design Spectral Response Acceleration at Short Periods, S_{DS} (g)	1.63
Design Spectral Response Acceleration at 1-second Period, S_{D1} (g)	1.02
Mapped MCE Geometric Mean (MCE_G) Peak Ground Acceleration, PGA (g)	0.94
Site Coefficient, F_{PGA}	1.00
MCE_G Peak Ground Acceleration adjusted for Site Class effects, PGA_M (g)	0.94
Long period transition-period, T_L	8 sec

5.2 PRELIMINARY FOUNDATION DESIGN

In order to reduce the effects of the potentially expansive soils, the foundations should be sufficiently stiff to move as rigid units with minimum differential movements. This can be accomplished with a post-tensioned mat foundation.

5.2.1 Post-Tensioned Mat Foundation Design

A minimum mat thickness of 10 inches should be anticipated for preliminary purposes. We anticipate that structural mats constructed on swelling soils will move differentially; therefore, structural mats may require stiffening to reduce differential movements due to swelling/shrinkage to a value compatible with the type of structure that will be constructed. The foundations should be designed for 2 inches differential seismic induced settlement over a distance of 30 feet. If the grading mitigation presented in Section 4.1.6 is not performed, at a higher risk to the structure, the foundations may be design to accommodate 3 inches of differential seismic induced settlement.

5.3 PRELIMINARY PAVEMENT DESIGN

The following preliminary pavement section has been determined for an assumed R-value of 5 and in accordance to the design methods contained in Chapter 630 of Caltrans Highway Design Manual.

TABLE 5.3-1: Preliminary Pavement Section

TRAFFIC INDEX	AC (INCHES)	AB (INCHES)
5.0	3.0	10.0
6.0	3.5	13.0
7.0	4.0	16.0

Note: AC – Asphalt Concrete
AB – Caltrans Class 2 aggregate base (R-value of 78 or greater)

The above preliminary pavement sections are provided for estimating only. We recommend the actual subgrade material should be tested for R-value and the Traffic Index and minimum pavement section(s) should be confirmed by the Civil Engineer and the City of Hayward.

5.4 DRAINAGE

The building pads must be positively graded at all times to provide for rapid removal of surface water runoff from the foundation systems and to prevent ponding of water under floors or seepage toward the foundation systems at any time during or after construction. Ponding of stormwater must not be permitted on the building pads during prolonged periods of inclement weather. All surface water should be collected and discharged into the storm drain system. Landscape mounds must not interfere with this requirement.

All roof stormwater should be collected and directed to downspouts. Stormwater from roof downspouts should be directed to a solid pipe that discharges to the street or to an approved outlet or onto an impervious surface, such as pavement that will drain at a 2 percent slope gradient.

Due to the generally high fines content anticipated in the near-surface site materials, the site soils encountered are not expected to have adequate permeability values to handle stormwater infiltration in grassy swales or permeable pavers. Therefore, best management practices should assume that little stormwater infiltration will occur at the site.

5.5 STORMWATER BIORETENTION AREAS

If bioretention areas are implemented, we recommend that, when practical, they be planned a minimum of 5 feet away from structural site improvements, such as buildings, streets, retaining walls, and sidewalks/driveways. When this is not practical, bioretention areas located within 5 feet of structural site improvements can either:

1. Be constructed with structural side walls capable of withstanding the loads from the adjacent improvements, or
2. Incorporate filter material compacted to between 85 and 90 percent relative compaction (ASTM D1557, latest edition) and a waterproofing system designed to reduce the potential for moisture transmission into the subgrade soil beneath the adjacent improvement.

In addition, one of the following options should be followed.

1. We recommend that bioretention design incorporate a waterproofing system lining the bioswale excavation and a subdrain, or other storm drain system, to collect and convey water to an approved outlet. The waterproofing system should cover the bioretention area excavation in such a manner as to reduce the potential for moisture transmission beneath the adjacent improvements.
2. Alternatively, and with some risk of movement of adjacent improvements, if infiltration is desired, we recommend the perimeter of the bioretention areas be lined with an HDPE tree root barrier that extends at least 1 foot below the bottom of the bioretention areas/infiltration trenches.

Site improvements located adjacent to bioretention areas that are underlain by base rock, sand, or other imported granular materials, should be designed with a deepened edge that extends to the bottom of the imported material underlying the improvement.

Where adjacent site improvements include buildings greater than three stories, streets steeper than 3 percent, or design elements subject to lateral loads (such as from impact or traffic patterns), additional design considerations may be recommended. If the surface of the bioretention area is depressed, the slope gradient should follow the slope guidelines described in earlier section(s) of this document. In addition, although not recommended, if trees are to be planted within bioretention areas, HDPE Tree Boxes that extend below the bottom of the bioretention system should be installed to reduce potential impact to subdrain systems that may be part of the bioretention area design. For this condition, the waterproofing system should be connected to the HDPE Tree Box with a waterproof seal.

Given the nature of bioretention systems and possible proximity to improvements, we recommend ENGEO be retained to review design plans and provide testing and observation services during the installation of linings, compaction of the filter material, and connection of designed drains.

It should be noted that the contractor is responsible for conducting all excavation and shoring in a manner that does not cause damage to adjacent improvements during construction and future maintenance of the bioretention areas. As with any excavation adjacent to improvements, the contractor should reduce the exposure time such that the improvements are not detrimentally impacted.

6.0 FUTURE STUDIES

As previously discussed, a site-specific design-level geotechnical exploration should be performed as part of the design process. Preliminary conclusions and recommendations presented herein are based on limited site and laboratory data. The exploration would include borings, test-pits, and laboratory soil testing to provide data for preparation of specific recommendations regarding grading, further assess the stability of creek bank slope, foundation design, corrosion potential, and drainage for the proposed development. The exploration will also allow for more detailed evaluations of the geotechnical issues discussed in this report and afford the opportunity to provide recommendations regarding techniques and procedures to be implemented during construction to mitigate potential geotechnical/geological hazards.

7.0 LIMITATIONS AND UNIFORMITY OF CONDITIONS

This report presents preliminary geotechnical recommendations for design of the improvements discussed in Section 1.3 for the B Street project. If changes occur in the nature or design of the project, we should be allowed to review this report and provide additional recommendations, if any. It is the responsibility of the owner to transmit the information and preliminary recommendations of this report to the appropriate organizations or people involved in design of the project, including but not limited to developers, owners, buyers, architects, engineers, and designers. The preliminary conclusions and recommendations contained in this report are solely professional opinions and are valid for a period of no more than 2 years from the date of report issuance.

We strived to perform our professional services in accordance with generally accepted geotechnical engineering principles and practices currently employed in the area; no warranty is expressed or implied. There are risks of earth movement and property damages inherent in building on or with earth materials. We are unable to eliminate all risks or provide insurance; therefore, we are unable to guarantee or warrant the results of our services.

This report is based upon field and other conditions discovered at the time of report preparation. We developed this report with limited subsurface exploration data. We assumed that our subsurface exploration data is representative of the actual subsurface conditions across the site. Considering possible underground variability of soil, rock, stockpiled material, and groundwater, additional costs may be required to complete the project. We recommend that the owner establish a contingency fund to cover such costs. If unexpected conditions are encountered, notify ENGEO immediately to review these conditions and provide additional and/or modified recommendations, as necessary.

Our services did not include excavation sloping or shoring, soil volume change factors, or a geohazard exploration. In addition, our geotechnical exploration did not include work to determine the existence of possible hazardous materials. If any hazardous materials are encountered during construction, then notify the proper regulatory officials immediately.

This document must not be subject to unauthorized reuse, that is, reusing without written authorization of ENGEO. Such authorization is essential because it requires ENGEO to evaluate the document's applicability given new circumstances, not the least of which is passage of time.

Actual field or other conditions will necessitate clarifications, adjustments, modifications or other changes to ENGEO's documents. Therefore, ENGEO must be engaged to prepare the necessary clarifications, adjustments, modifications or other changes before construction activities commence or further activity proceeds. If ENGEO's scope of services does not include onsite construction observation, or if other persons or entities are retained to provide such services, ENGEO cannot be held responsible for any or all claims arising from or resulting from the performance of such services by other persons or entities, and from any or all claims arising from or resulting from clarifications, adjustments, modifications, discrepancies or other changes necessary to reflect changed field or other conditions.

SELECTED REFERENCES

- American Society of Civil Engineers. Minimum Design Loads for Buildings and other Structures ASCE 7-10. Reston: American Society of Civil Engineers. 2010.
- Boulanger, R. W. and Idriss, I. M. (2014). CPT and SPT Based Liquefaction Triggering and Procedures. Report No. UCD/CGM-14/01.
- Bjerrum, L. and Simons, N. E. (1960). Comparisons of shear strength characteristics of normally consolidated clays, Proceedings of the ASCE Research Conference on the Shear Strength of Cohesive Soils, Boulder, CO, pp. 711-726.
- California Building Standards Commission, 2016 California Building Code, Volumes 1 and 2. Sacramento, California.
- California Division of Mines and Geology, 1982, Special Studies Zone Maps, Hayward Quadrangle, California, State of California.
- California Department of Transportation, 2010, Highway Design Manual.
- California Geological Survey, 2008, Guidelines for Evaluating and Mitigating Seismic Hazards in California, Special Publication 117A.
- California Geological Survey, 2003, Seismic Hazard Zones Report for the Hayward 7.5-Minute Quadrangle, Alameda County, California.
- Field, E.H., Biasi, G.P., Bird, P., Dawson, T.E., Felzer, K.R., Jackson, D.D., Johnson, K.M., Jordan, T.H., Madden, C., Michael, A.J., Milner, K.R., Page, M.T., Parsons, T., Powers, P.M., Shaw, B.E., Thatcher, W.R., Weldon, R.J., II, and Zeng, Y., 2013, Uniform California earthquake rupture forecast, version 3 (UCERF3)—The time-independent model: U.S. Geological Survey Open-File Report 2013–1165, 97 p., California Geological Survey Special Report 228, and Southern California Earthquake Center Publication 1792, <http://pubs.usgs.gov/of/2013/1165/>
- Hart, E.W. and Bryant, W.A., 1997, Fault rupture hazard in California: Alquist-Priolo earthquake fault zoning act with index to earthquake fault zone maps: California Division of Mines and Geology Special Publication 42.
- Helley, E.J. and Graymer, R. W., 1997, Quaternary geology of Alameda County, and parts of Contra Costa, Santa Clara, San Mateo, San Francisco, Stanislaus, and San Joaquin Counties, California. Open-File Report 97-97 scale 1:100,000.
- International Code Council (2012). California Building Code.
- Idriss, I. M., and Boulanger, R. W. (2008). Soil liquefaction during earthquakes. Monograph MNO-12, Earthquake Engineering Research Institute, Oakland, CA, 261 pp.
- Ishihara, K. (1985), Stability of Natural Deposits During Earthquakes, Proc 11th International Conference on Soil Mechanics and Foundation Engineering, Vol 1, A. A. Balkema, Rotterdam, The Netherlands, 321-376.

SELECTED REFERENCES (Continued)

- Ishihara, K. and Ishihara, K. and Yoshimine, M. (1992). "Evaluation of Settlements in Sand Deposits Following Liquefaction During Earthquakes." Soils and Foundations, Vol. 32, No. 1, March pp. 173-188.
- Post-Tensioning Institute, 2004, Design of Post-Tensioned Slabs-on-Ground, Third Edition.
- Robertson, P. K. and Campanella, R. G., Guidelines for Geotechnical Design Using CPT and CPTU Data.
- Robertson, P. K. (2009), Performance based earthquake design using the CPT, Gregg Drilling and Testing, Inc.
- Spencer, E. (1967). A method of analysis of the stability of embankments assuming parallel interslice forces, Geotechnique, 17(1), 11-26.
- State of California, California Geologic Survey (CGS), 2003, Seismic Hazard Zones, Official Map, Hayward Quadrangle, July 2, 2003.
- Southern California Earthquake Center (1999), Recommended Procedures For Implementation of DMG Special Publication 117 Guidelines for Analyzing and Mitigating Liquefaction in California.
- Stark, T. D., and Eid, H. T. (1994). Drained residual strength of cohesive soils, ASCE, Journal of Geotechnical Engineering, 120, 856-871.
- Stewart, J., Liu A. H., Choi, Y., (2003) Amplification factors for Spectral Acceleration in Tectonically active Regions, Bull. Seism. Soc. A., Vol. 93, No. 1, 332-352.
- Structural Engineers Association of California (SEAOC) (1996). Recommended Lateral Force Requirements and Tentative Commentary.
- Tokimatsu, K. and Seed, H. B. (1987). "Evaluation of Settlements in Sands due to Earthquake Shaking." Journal of Geotechnical Engineering, Vol. 113, No. 8, pp. 861-878.
- Youd, T. L. and C. T. Garris, 1995, Liquefaction induced Ground-Surface Description: Journal of Geotechnical Engineering, Vol. 121, No. 11, pp. 805 – 809.
- Youd T. L. et al. (2001) "Liquefaction Resistance of Soils: Summary Report from the NCEER/NSF Workshop on Evaluation of Liquefaction Resistance of Soils." Journal of Geotechnical and Geoenvironmental Engineering., ASCE, 127(10), Oct., pp. 817-833.
- Zhang, G. Robertson. P.K, Brachman, R., 2002, Estimating Liquefaction Induced Ground Settlements from the CPT, Canadian Geotechnical Journal, 39: pp 1168-1180.



FIGURES

FIGURE 1: Vicinity Map

FIGURE 2: Site Plan

FIGURE 3: Regional Geologic Map (Graymer)

FIGURE 4: Earthquake Zones of Required Investigation

FIGURE 5: Regional Faulting and Seismicity Map

COPYRIGHT © 2017 BY ENGEO INCORPORATED. THIS DOCUMENT MAY NOT BE REPRODUCED IN WHOLE OR IN PART BY ANY MEANS WHATSOEVER, NOR MAY IT BE QUOTED OR EXCERPTED WITHOUT THE EXPRESS WRITTEN CONSENT OF ENGEO INCORPORATED.

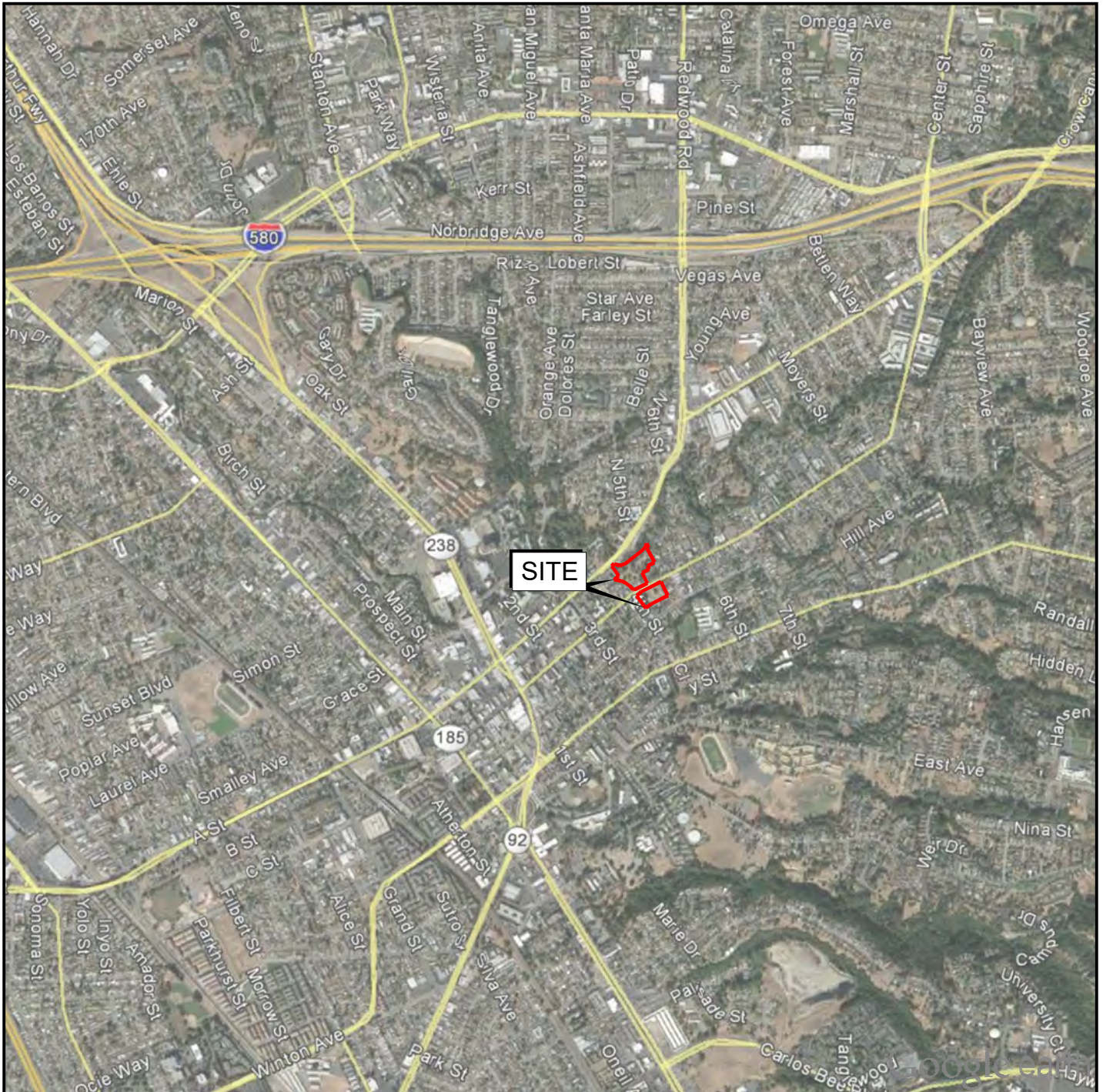

BASE MAP SOURCE: GOOGLE EARTH MAPPING SERVICE



VICINITY MAP
 B STREET PROJECT
 HAYWARD, CALIFORNIA

PROJECT NO.: 13599.000.000	
SCALE: AS SHOWN	
DRAWN BY: LL	CHECKED BY: JTT

FIGURE NO.
1

COPYRIGHT © 2017 BY ENGEO INCORPORATED. THIS DOCUMENT MAY NOT BE REPRODUCED IN WHOLE OR IN PART BY ANY MEANS WHATSOEVER, NOR MAY IT BE QUOTED OR EXCERPTED WITHOUT THE EXPRESS WRITTEN CONSENT OF ENGEO INCORPORATED.

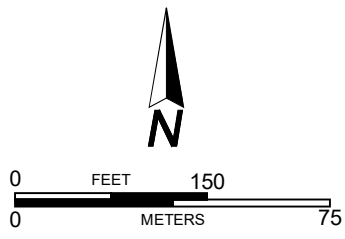

EXPLANATION

ALL LOCATIONS ARE APPROXIMATE

- PROJECT BOUNDARY
- 1-CPT-5
CONE PENETRATION TEST (ENGEO, 2016)
- WELL LOCATION

BASE MAP SOURCE: GOOGLE EARTH MAPPING SERVICE



SITE PLAN
B STREET PROJECT
 HAYWARD, CALIFORNIA

PROJECT NO.: 13599.000.000	
SCALE: AS SHOWN	
DRAWN BY: LL	CHECKED BY: JTT

FIGURE NO.
2

COPYRIGHT © 2017 BY ENGeo INCORPORATED. THIS DOCUMENT MAY NOT BE REPRODUCED IN WHOLE OR IN PART BY ANY MEANS WHATSOEVER, NOR MAY IT BE QUOTED OR EXCERPTED WITHOUT THE EXPRESS WRITTEN CONSENT OF ENGeo INCORPORATED.

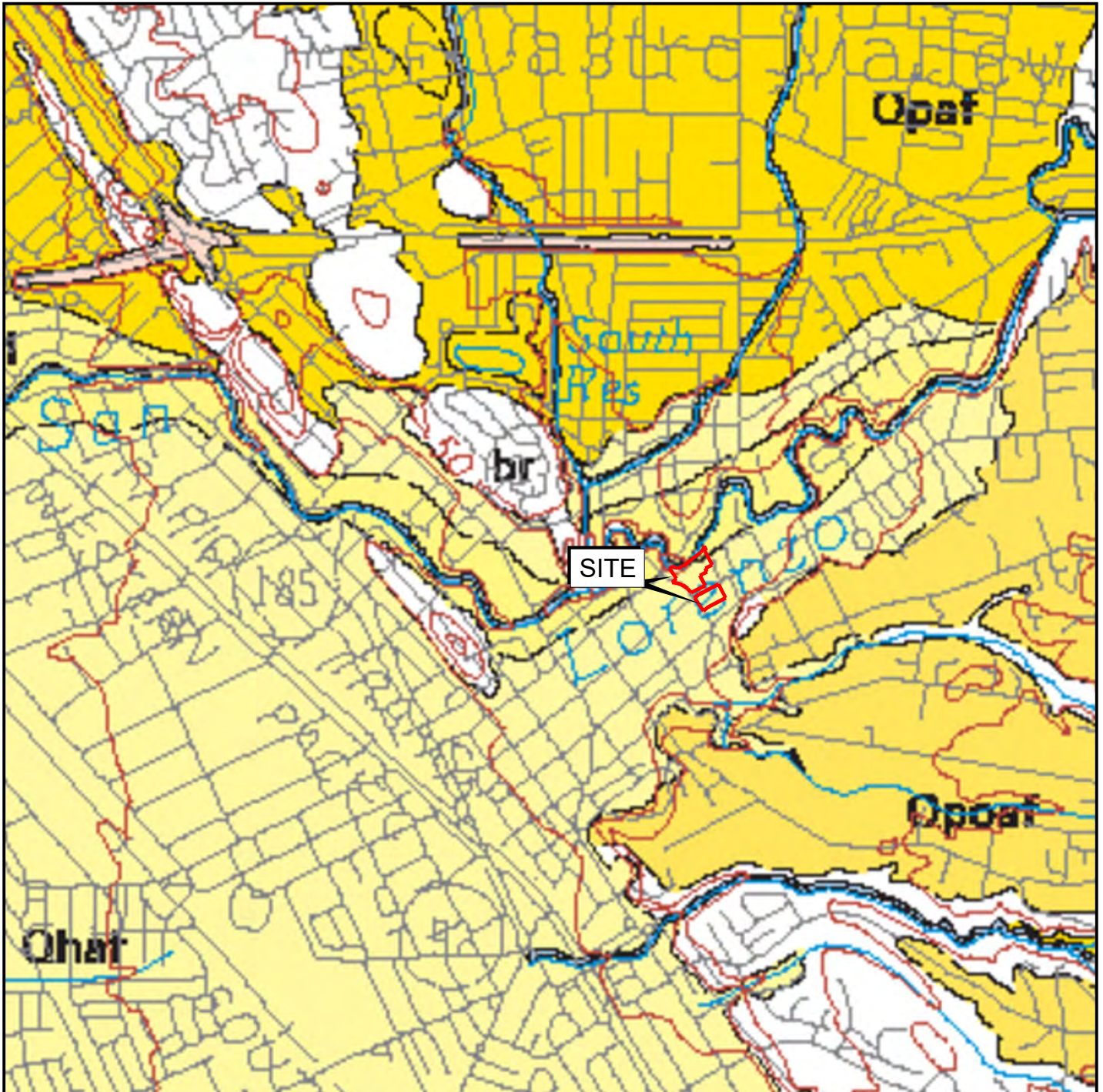

EXPLANATION

- Qhaf ALLUVIAL FAN DEPOSITS (HOLOCENE)
- Qpaf ALLUVIAL FAN DEPOSITS (PLEISTOCENE)
- Qpoaf OLDER ALLUVIAL FAN DEPOSITS (PLEISTOCENE)
- br UNDIFFERENTIATED BEDROCK (PLIOCENE AND OLDER)

BASE MAP SOURCE: GRAYMER, 1997



REGIONAL GEOLOGIC MAP
B STREET PROJECT
HAYWARD, CALIFORNIA

PROJECT NO.: 13599.000.000

SCALE: AS SHOWN

DRAWN BY: LL

CHECKED BY: JTT

FIGURE NO.

3

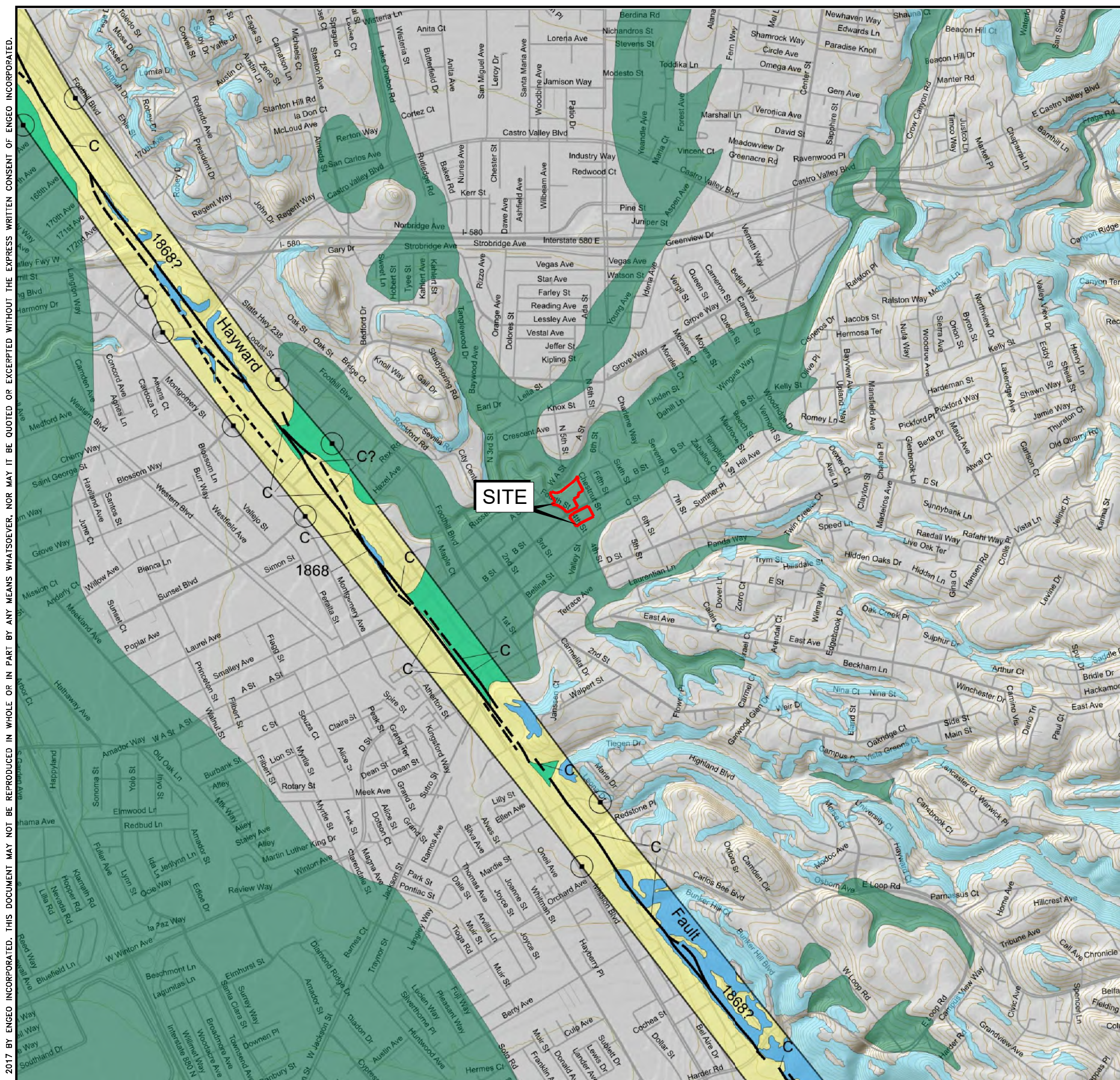

EXPLANATION

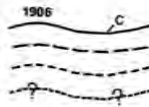
- 

ACTIVE FAULT TRACE
 FAULTS CONSIDERED TO HAVE BEEN ACTIVE DURING HOLOCENE TIME AND TO HAVE POTENTIAL FOR SURFACE RUPTURE; SOLID LINE WHERE ACCURATELY LOCATED, LONG DASH WHERE APPROXIMATELY LOCATED, SHORT DASH WHERE INFERRED, DOTTED WHERE CONCEALED; QUERY (?) INDICATED ADDITIONAL UNCERTAINTY. EVIDENCE OF HISTORIC OFFSET INDICATED BY YEAR OF EARTHQUAKE-ASSOCIATED EVENT OR C FOR DISPLACEMENT CAUSED BY FAULT CREEP
- 

EARTHQUAKE FAULT ZONES
 ZONES ARE AREAS DELINEATED AS STRAIGHT-LINE SEGMENTS THAT CONNECT ENCIRCLED TURNING POINTS ENCOMPASSING ACTIVE FAULTS THAT CONSTITUTE A POTENTIAL HAZARD TO STRUCTURES FROM SURFACE FAULTING OR FAULT CREEP SUCH THAT AVOIDANCE AS DEFINED IN PUBLIC RESOURCE CODE SECTION 2621.5(a) WOULD BE REQUIRED
- 

LIQUEFACTION
 AREAS WHERE HISTORIC OCCURRENCE OF LIQUEFACTION, OR LOCAL GEOLOGICAL, GEOTECHNICAL AND GROUNDWATER CONDITIONS INDICATE A POTENTIAL FOR PERMANENT GROUND DISPLACEMENTS SUCH THAT MITIGATION AS DEFINED IN PUBLIC RESOURCES CODE SECTION 2693(c) WOULD BE REQUIRED
- 

EARTHQUAKE-INDUCED LANDSLIDES
 AREAS WHERE PREVIOUS OCCURRENCE OF LANDSLIDE MOVEMENT, OR LOCAL TOPOGRAPHIC, GEOLOGICAL, GEOTECHNICAL AND SUBSURFACE WATER CONDITIONS INDICATE A POTENTIAL FOR PERMANENT GROUND DISPLACEMENTS SUCH THAT MITIGATION AS DEFINED IN PUBLIC RESOURCES CODE SECTION 2693(c) WOULD BE REQUIRED

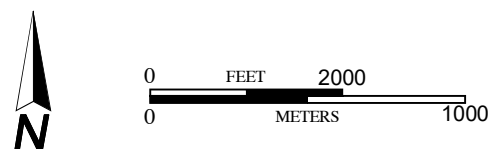

COPYRIGHT © 2017 BY ENGEO INCORPORATED. THIS DOCUMENT MAY NOT BE REPRODUCED IN WHOLE OR IN PART BY ANY MEANS WHATSOEVER, NOR MAY IT BE QUOTED OR EXCERPTED WITHOUT THE EXPRESS WRITTEN CONSENT OF ENGEO INCORPORATED.

BASE MAP SOURCE: CALIFORNIA DEPARTMENT OF CONSERVATION, CALIFORNIA GEOLOGICAL SURVEY, 2012



EARTHQUAKE ZONES OF REQUIRED INVESTIGATION
 B STREET PROJECT
 HAYWARD, CALIFORNIA

PROJECT NO.: 13599.000.000	4
SCALE: AS SHOWN	
DRAWN BY: LL CHECKED BY: JTT	

FIGURE NO.
4

COPYRIGHT © 2017 BY ENGeo INCORPORATED. THIS DOCUMENT MAY NOT BE REPRODUCED IN WHOLE OR IN PART BY ANY MEANS WHATSOEVER, NOR MAY IT BE QUOTED OR EXCERPTED WITHOUT THE EXPRESS WRITTEN CONSENT OF ENGeo INCORPORATED.

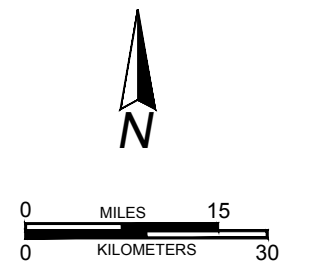
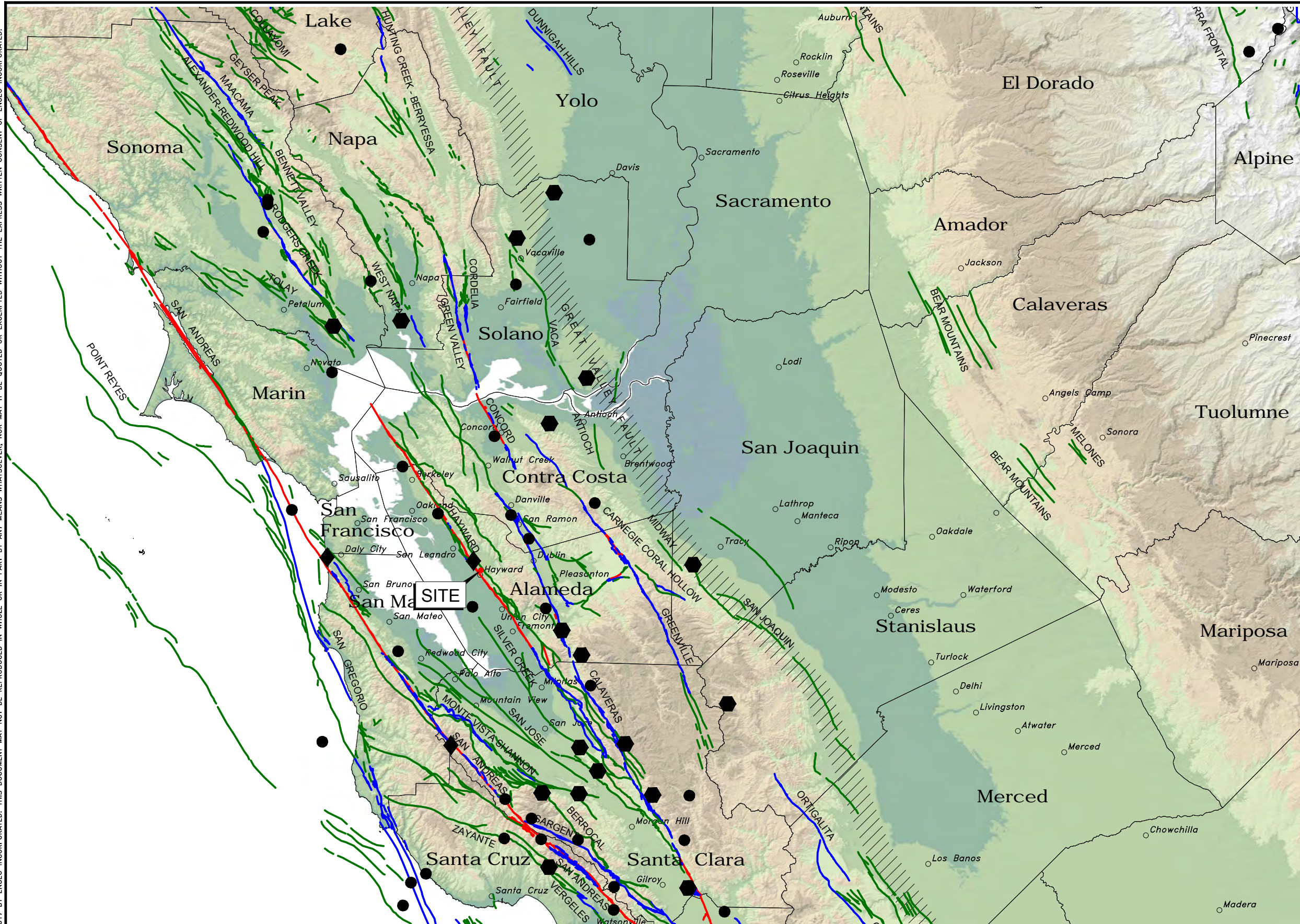

EXPLANATION

	MAGNITUDE 7+
	MAGNITUDE 6-7
	MAGNITUDE 5-6
	HISTORIC FAULT
	HOLOCENE FAULT
	QUATERNARY FAULT
	HISTORIC BLIND THRUST FAULT ZONE

BASE MAP SOURCE:
 COLOR HILLSHADE IMAGE BASED ON THE NATIONAL ELEVATION DATASET (NED) AT 30 METER RESOLUTION
 U.S.G.S. QUATERNARY FAULT DATABASE, NOVEMBER, 2010
 U.S.G.S. HISTORIC EARTHQUAKE DATABASE (1800-2000)

BASE MAP SOURCE: UNKNOWN



REGIONAL FAULTING AND SEISMICITY
 B STREET PROJECT
 HAYWARD, CALIFORNIA

PROJECT NO.: 13599.000.000	FIGURE NO.
SCALE: AS SHOWN	5
DRAWN BY: LL	



APPENDIX A

CONE PENETRATION TESTS (CPTS)

PRESENTATION OF SITE INVESTIGATION RESULTS

B Street Project, Hayward, CA

Prepared for:

ENGEO Incorporated

CPT Inc. Job No: 16-56101

Project Start Date: 23-Dec-2016

Project End Date: 23-Dec-2016

Report Date: 28-Dec-2016



Prepared by:

California Push Technologies Inc.
820 Aladdin Avenue
San Leandro, CA 94577

Tel: (510) 357-3677

Email: cpt@cptinc.com

www.cptinc.com



B Street Project, Hayward, CA

Introduction

The enclosed report presents the results of the site investigation program conducted by CPT Inc. for ENGEO Incorporated at B Street, Hayward, CA. The program consisted of 5 cone penetration tests (CPT).

Project Information

Project	
Client	ENGEO Incorporated
Project	B Street Project, Hayward, CA
CPT Inc. project number	16-56101

A map from Google earth including the CPT test locations is presented below.

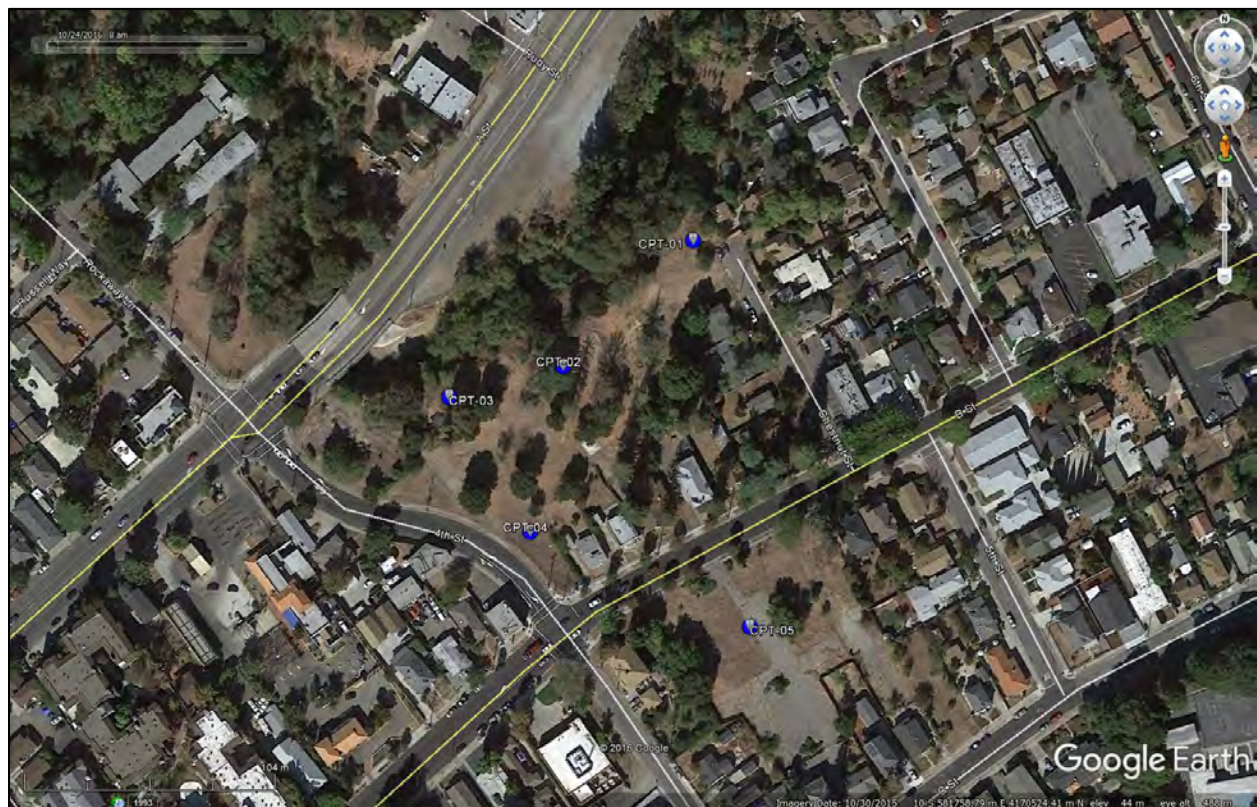

Rig Description	Deployment System	Test Type
CPT Track Rig (GPT1)	20 ton rig cylinder	CPT

B Street Project, Hayward, CA

Coordinates		
Test Type	Collection Method	EPSG Reference
CPT	Consumer Grade GPS	32610

Cone Penetration Test (CPT)	
Depth reference	Depths are referenced to the existing ground surface at the time of each test.
Depth recording interval	2.5 cm
Tip and sleeve data offset	0.1 meter This has been accounted for in the CPT data files.
Additional plots	Advanced CPT plots are provided in the data release folder.

Cone Penetrometers Used for this Project						
Cone Description	Cone Number	Cross Sectional Area (cm ²)	Sleeve Area (cm ²)	Tip Capacity (bar)	Sleeve Capacity (bar)	Pore Pressure Capacity (psi)
443:T1500F15U500	443	15	225	1500	15	500
Cone 443 was used for all CPT soundings.						

Interpretation Tables	
Additional information	<p>The Soil Behaviour Type (SBT) classification chart (Robertson et al., 1986) was used to classify the soil for this project. A detailed set of CPT interpretations were generated and are provided in Excel format files in the release folder. The CPT interpretations are based on values of corrected tip (q_t), sleeve friction (f_s) and pore pressure (u_2).</p> <p>Soils were classified as either drained or undrained based on the Soil Behaviour Type (SBT) classification chart (Robertson et al., 1986). Calculations for both drained and undrained parameters were included for materials that classified as silt (zone 6). Undefined materials (zone 0) were classified as undrained. CPT sounding CPT-01 had both drained and undrained parameters for materials that classified as silt (zone 6) and sandy silt (zone 7).</p>

Limitations

This report has been prepared for the exclusive use of ENGEO Incorporated (Client) for the project titled "B Street Project, Hayward, CA". The report's contents may not be relied upon by any other party without the express written permission of CPT Inc. CPT Inc. has provided site investigation services, prepared the factual data reporting, and provided geotechnical parameter calculations consistent with current best practices. No other warranty, expressed or implied, is made.

The information presented in the report document and the accompanying data set pertain to the specific project, site conditions and objectives described to CPT Inc. by the Client. In order to properly understand the factual data, assumptions and calculations, reference must be made to the documents provided and their accompanying data sets, in their entirety.

CONE PENETRATION TEST

The cone penetration tests (CPTu) are conducted using an integrated electronic piezocone penetrometer and data acquisition system manufactured by Adara Systems Ltd. of Richmond, British Columbia, Canada.

CPT Inc.'s piezocone penetrometers are compression type designs in which the tip and friction sleeve load cells are independent and have separate load capacities. The piezocones use strain gauged load cells for tip and sleeve friction and a strain gauged diaphragm type transducer for recording pore pressure. The piezocones also have a platinum resistive temperature device (RTD) for monitoring the temperature of the sensors, an accelerometer type dual axis inclinometer and a geophone sensor for recording seismic signals. All signals are amplified down hole within the cone body and the analog signals are sent to the surface through a shielded cable.

The penetrometers are manufactured with various tip, friction and pore pressure capacities in both 10 cm² and 15 cm² tip base area configurations in order to maximize signal resolution for various soil conditions. The specific piezocone used for each test is described in the CPT summary table presented in the first appendix. The 15 cm² penetrometers do not require friction reducers as they have a diameter larger than the deployment rods. The 10 cm² piezocones use a friction reducer consisting of a rod adapter extension behind the main cone body with an enlarged cross sectional area (typically 44 mm diameter over a length of 32 mm with tapered leading and trailing edges) located at a distance of 585 mm above the cone tip.

The penetrometers are designed with equal end area friction sleeves, a net end area ratio of 0.8 and cone tips with a 60 degree apex angle.

All piezocones can record pore pressure at various locations. Unless otherwise noted, the pore pressure filter is located directly behind the cone tip in the "u₂" position (ASTM Type 2). The filter is 6 mm thick, made of porous plastic (polyethylene) having an average pore size of 125 microns (90-160 microns). The function of the filter is to allow rapid movements of extremely small volumes of water needed to activate the pressure transducer while preventing soil ingress or blockage.

The piezocone penetrometers are manufactured with dimensions, tolerances and sensor characteristics that are in general accordance with the current ASTM D5778 standard. Our calibration criteria also meet or exceed those of the current ASTM D5778 standard. An illustration of the piezocone penetrometer is presented in Figure CPTu.

CONE PENETRATION TEST

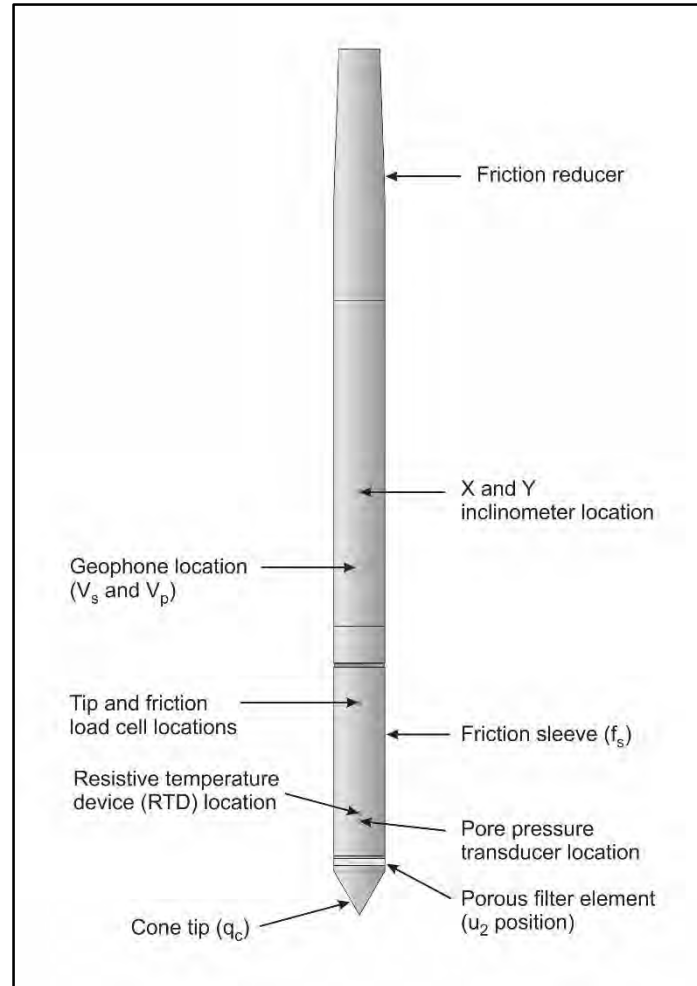
Figure CPTu. Piezocone Penetrometer (15 cm²)

The data acquisition systems consist of a Windows based computer and a signal conditioner and power supply interface box with a 16 bit (or greater) analog to digital (A/D) converter. The data is recorded at fixed depth increments using a depth wheel attached to the push cylinders or by using a spring loaded rubber depth wheel that is held against the cone rods. The typical recording intervals are either 2.5 cm or 5.0 cm depending on project requirements; custom recording intervals are possible. The system displays the CPTu data in real time and records the following parameters to a storage media during penetration:

- Depth
- Uncorrected tip resistance (q_c)
- Sleeve friction (f_s)
- Dynamic pore pressure (u)
- Additional sensors such as resistivity, passive gamma, ultra violet induced fluorescence, if applicable

All testing is performed in accordance to CPT Inc.'s CPT operating procedures which are in general accordance with the current ASTM D5778 standard.

CONE PENETRATION TEST

Prior to the start of a CPTu sounding a suitable cone is selected, the cone and data acquisition system are powered on, the pore pressure system is saturated with either glycerin or silicone oil and the baseline readings are recorded with the cone hanging freely in a vertical position.

The CPTu is conducted at a steady rate of 2 cm/s, within acceptable tolerances. Typically one meter length rods with an outer diameter of 1.5 inches are added to advance the cone to the sounding termination depth. After cone retraction final baselines are recorded.

Additional information pertaining to CPT Inc.'s cone penetration testing procedures:

- Each filter is saturated in silicone oil or glycerin under vacuum pressure prior to use
- Recorded baselines are checked with an independent multi-meter
- Baseline readings are compared to previous readings
- Soundings are terminated at the client's target depth or at a depth where an obstruction is encountered, excessive rod flex occurs, excessive inclination occurs, equipment damage is likely to take place, or a dangerous working environment arises
- Differences between initial and final baselines are calculated to ensure zero load offsets have not occurred and to ensure compliance with ASTM standards

The interpretation of the piezocone data and associated calculated parameters for this report are based on the corrected tip resistance (q_t), sleeve friction (f_s) and pore water pressure (u). The interpretation of soil type is based on the correlations developed by Robertson (1990) and Robertson (2009). It should be noted that it is not always possible to accurately identify a soil type based on these parameters. In these situations, experience, judgment and an assessment of other parameters may be used to infer soil behavior type.

The recorded tip resistance (q_c) is the total force acting on the piezocone tip divided by its base area. The tip resistance is corrected for pore pressure effects and termed corrected tip resistance (q_t) according to the following expression presented in Robertson et al, 1986:

$$q_t = q_c + (1-a) \cdot u_2$$

where: q_t is the corrected tip resistance

q_c is the recorded tip resistance

u_2 is the recorded dynamic pore pressure behind the tip (u_2 position)

a is the Net Area Ratio for the piezocone (0.8 for CPT Inc. probes)

The sleeve friction (f_s) is the frictional force on the sleeve divided by its surface area. As all CPT Inc. piezocones have equal end area friction sleeves, pore pressure corrections to the sleeve data are not required.

The dynamic pore pressure (u) is a measure of the pore pressures generated during cone penetration. To record equilibrium pore pressure, the penetration must be stopped to allow the dynamic pore pressures to stabilize. The rate at which this occurs is predominantly a function of the permeability of the soil and the diameter of the cone.

CONE PENETRATION TEST

The friction ratio (R_f) is a calculated parameter. It is defined as the ratio of sleeve friction to the tip resistance expressed as a percentage. Generally, saturated cohesive soils have low tip resistance, high friction ratios and generate large excess pore water pressures. Cohesionless soils have higher tip resistances, lower friction ratios and do not generate significant excess pore water pressure.

A summary of the CPTu soundings along with test details and individual plots are provided in the appendices. A set of files with calculated geotechnical parameters were generated for each sounding based on published correlations and are provided in Excel format in the data release folder. Information regarding the methods used is also included in the data release folder.

For additional information on CPTu interpretations and calculated geotechnical parameters, refer to Robertson et al. (1986), Lunne et al. (1997), Robertson (2009), Mayne (2013, 2014) and Mayne and Peuchen (2012).

PORE PRESSURE DISSIPATION TEST

The cone penetration test is halted at specific depths to carry out pore pressure dissipation (PPD) tests, shown in Figure PPD-1. For each dissipation test the cone and rods are decoupled from the rig and the data acquisition system measures and records the variation of the pore pressure (u) with time (t).

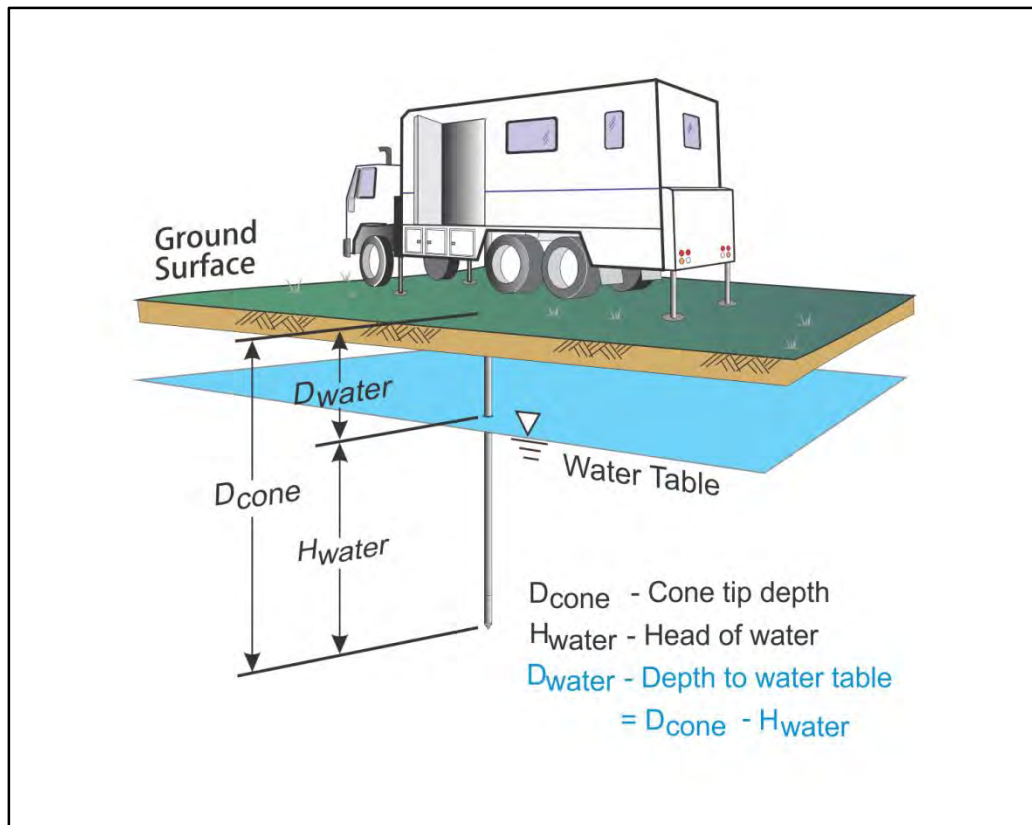

Figure PPD-1. Pore pressure dissipation test setup

Pore pressure dissipation data can be interpreted to provide estimates of ground water conditions, permeability, consolidation characteristics and soil behavior.

The typical shapes of dissipation curves shown in Figure PPD-2 are very useful in assessing soil type, drainage, in situ pore pressure and soil properties. A flat curve that stabilizes quickly is typical of a freely draining sand. Undrained soils such as clays will typically show positive excess pore pressure and have long dissipation times. Dilative soils will often exhibit dynamic pore pressures below equilibrium that then rise over time. Overconsolidated fine-grained soils will often exhibit an initial dilatatory response where there is an initial rise in pore pressure before reaching a peak and dissipating.

PORE PRESSURE DISSIPATION TEST

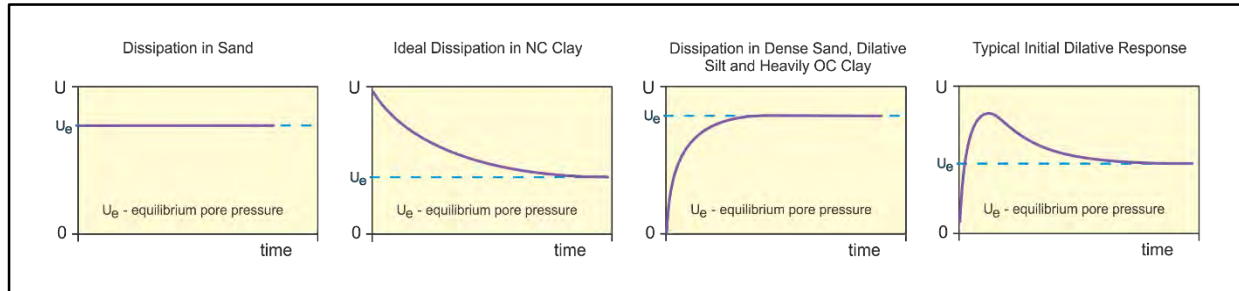

Figure PPD-2. Pore pressure dissipation curve examples

In order to interpret the equilibrium pore pressure (u_{eq}) and the apparent phreatic surface, the pore pressure should be monitored until such time as there is no variation in pore pressure with time as shown for each curve of Figure PPD-2.

In fine grained deposits the point at which 100% of the excess pore pressure has dissipated is known as t_{100} . In some cases this can take an excessive amount of time and it may be impractical to take the dissipation to t_{100} . A theoretical analysis of pore pressure dissipations by Teh and Houlsby (1991) showed that a single curve relating degree of dissipation versus theoretical time factor (T^*) may be used to calculate the coefficient of consolidation (c_h) at various degrees of dissipation resulting in the expression for c_h shown below.

$$c_h = \frac{T^* \cdot a^2 \cdot \sqrt{I_r}}{t}$$

Where:

- T^* is the dimensionless time factor (Table Time Factor)
- a is the radius of the cone
- I_r is the rigidity index
- t is the time at the degree of consolidation

Table Time Factor. T^* versus degree of dissipation (Teh and Houlsby, 1991)

Degree of Dissipation (%)	20	30	40	50	60	70	80
$T^* (u_2)$	0.038	0.078	0.142	0.245	0.439	0.804	1.60

The coefficient of consolidation is typically analyzed using the time (t_{50}) corresponding to a degree of dissipation of 50% (u_{50}). In order to determine t_{50} , dissipation tests must be taken to a pressure less than u_{50} . The u_{50} value is half way between the initial maximum pore pressure and the equilibrium pore pressure value, known as u_{100} . To estimate u_{50} , both the initial maximum pore pressure and u_{100} must be known or estimated. Other degrees of dissipations may be considered, particularly for extremely long dissipations.

At any specific degree of dissipation the equilibrium pore pressure (u at t_{100}) must be estimated at the depth of interest. The equilibrium value may be determined from one or more sources such as measuring the value directly (u_{100}), estimating it from other dissipations in the same profile, estimating the phreatic surface and assuming hydrostatic conditions, from nearby soundings, from client provided information, from site observations and/or past experience, or from other site instrumentation.

PORE PRESSURE DISSIPATION TEST

For calculations of c_h (Teh and Houlsby, 1991), t_{50} values are estimated from the corresponding pore pressure dissipation curve and a rigidity index (I_r) is assumed. For curves having an initial dilatatory response in which an initial rise in pore pressure occurs before reaching a peak, the relative time from the peak value is used in determining t_{50} . In cases where the time to peak is excessive, t_{50} values are not calculated.

Due to possible inherent uncertainties in estimating I_r , the equilibrium pore pressure and the effect of an initial dilatatory response on calculating t_{50} , other methods should be applied to confirm the results for c_h .

Additional published methods for estimating the coefficient of consolidation from a piezocone test are described in Burns and Mayne (1998, 2002), Jones and Van Zyl (1981), Robertson et al. (1992) and Sully et al. (1999).

A summary of the pore pressure dissipation tests and dissipation plots are presented in the relevant appendix.

REFERENCES

ASTM D5778-12, 2012, "Standard Test Method for Performing Electronic Friction Cone and Piezocone Penetration Testing of Soils", ASTM, West Conshohocken, US.

Burns, S.E. and Mayne, P.W., 1998, "Monotonic and dilatatory pore pressure decay during piezocone tests", Canadian Geotechnical Journal 26 (4): 1063-1073.

Burns, S.E. and Mayne, P.W., 2002, "Analytical cavity expansion-critical state model cone dissipation in fine-grained soils", Soils & Foundations, Vol. 42(2): 131-137.

Jones, G.A. and Van Zyl, D.J.A., 1981, "The piezometer probe: a useful investigation tool", Proceedings, 10th International Conference on Soil Mechanics and Foundation Engineering, Vol. 3, Stockholm: 489-495.

Lunne, T., Robertson, P.K. and Powell, J. J. M., 1997, "Cone Penetration Testing in Geotechnical Practice", Blackie Academic and Professional.

Mayne, P.W., 2013, "Evaluating yield stress of soils from laboratory consolidation and in-situ cone penetration tests", Sound Geotechnical Research to Practice (Holtz Volume) GSP 230, ASCE, Reston/VA: 406-420.

Mayne, P.W., 2014, "Interpretation of geotechnical parameters from seismic piezocone tests", CPT'14 Keynote Address, Las Vegas, NV, May 2014.

Mayne, P.W. and Peuchen, J., 2012, "Unit weight trends with cone resistance in soft to firm clays", Geotechnical and Geophysical Site Characterization 4, Vol. 1 (Proc. ISC-4, Pernambuco), CRC Press, London: 903-910.

Robertson, P.K., 1990, "Soil Classification Using the Cone Penetration Test", Canadian Geotechnical Journal, Volume 27: 151-158.

Robertson, P.K., 2009, "Interpretation of cone penetration tests – a unified approach", Canadian Geotechnical Journal, Volume 46: 1337-1355.

Robertson, P.K., Campanella, R.G., Gillespie, D. and Greig, J., 1986, "Use of Piezometer Cone Data", Proceedings of InSitu 86, ASCE Specialty Conference, Blacksburg, Virginia.

Robertson, P.K., Sully, J.P., Woeller, D.J., Lunne, T., Powell, J.J.M. and Gillespie, D.G., 1992, "Estimating coefficient of consolidation from piezocone tests", Canadian Geotechnical Journal, 29(4): 551-557.

Sully, J.P., Robertson, P.K., Campanella, R.G. and Woeller, D.J., 1999, "An approach to evaluation of field CPTU dissipation data in overconsolidated fine-grained soils", Canadian Geotechnical Journal, 36(2): 369-381.

Teh, C.I., and Houlsby, G.T., 1991, "An analytical study of the cone penetration test in clay", Geotechnique, 41(1): 17-34.

APPENDICES

The appendices listed below are included in the report:

- Cone Penetration Test Summary and Standard Cone Penetration Test Plots
- Advanced Cone Penetration Test Plots with I_c , $S_u(Nkt)$ and $N1(60)$
- Pore Pressure Dissipation Summary and Pore Pressure Dissipation Plots

Cone Penetration Test Summary and Standard Cone Penetration Test Plots



Job No: 16-56101
 Client: ENGEO Inc.
 Project: B Street Project, Hayward, CA
 Start Date: 23-Dec-2016
 End Date: 23-Dec-2016

CONE PENETRATION TEST SUMMARY

Sounding ID	File Name	Date	Cone	Assumed Phreatic Surface ¹ (ft)	Final Depth (ft)	Northing ² (m)	Easting (m)	Refer to Notation Number
CPT-01	16-56101_CP01	23-Dec-16	443:T1500F15U500	23.9	36.335	4170632	581551	4
CPT-02	16-56101_CP02	23-Dec-16	443:T1500F15U500		22.556	4170580	581498	3
CPT-03	16-56101_CP03	23-Dec-16	443:T1500F15U500		34.694	4170567	581451	3
CPT-04	16-56101_CP04	23-Dec-16	443:T1500F15U500		22.473	4170512	581485	3
CPT-05	16-56101_CP05	23-Dec-16	443:T1500F15U500	11.2	45.603	4170474	581576	

1. The assumed phreatic surface was based on pore pressure dissipation tests unless otherwise noted.
Hydrostatic conditions were assumed for the CPT calculated geotechnical parameters.
2. The coordinates were obtained using consumer-grade GPS device with datum WGS84/UTM Zone 10 North.
3. Phreatic surface not detected. Unsaturated conditions assumed for the CPT calculated geotechnical parameters.
4. Assumed phreatic surface based on the dynamic pore pressure response.



ENGEO Inc.

Job No: 16-56101
 Date: 12:23:16 08:32
 Site: Hayward, CA

Sounding: CPT-01
 Cone: 443:T1500F15U500

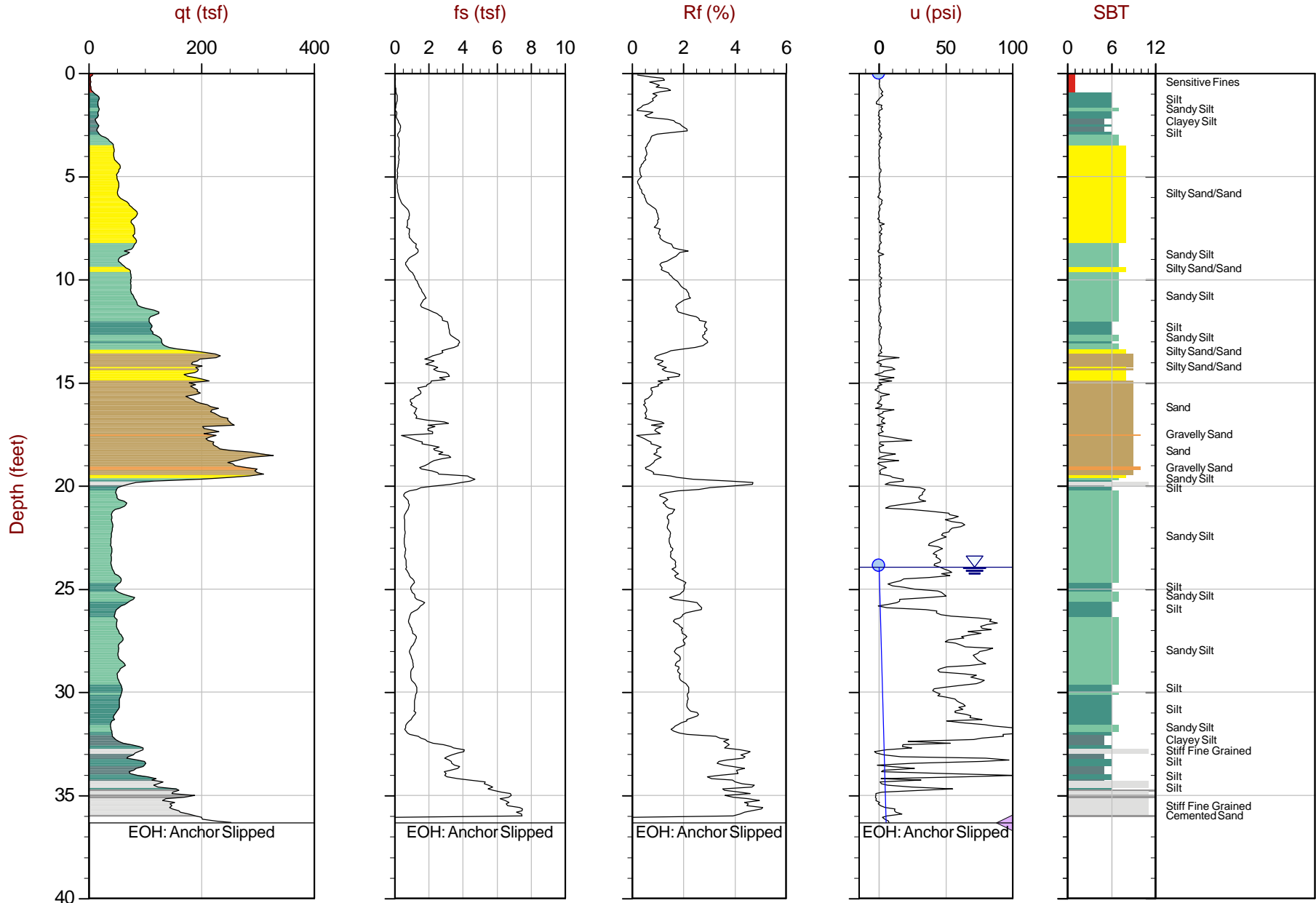

Max Depth: 11.075 m / 36.33 ft
 Depth Inc: 0.025 m / 0.082 ft
 Avg Int: Every Point

File: 16-56101_CP01.COR
 Unit Wt: SBT Zones

SBT: Robertson and Campanella, 1986
 Coords: UTM Zone 10N: 4170632m E: 581551m
 Page No: 1 of 1

● Equilibrium Pore Pressure (Ueq)
 ● Assumed Ueq
 ◀ Dissipation, Ueq achieved
 ◀ Dissipation, Ueq not achieved
 — Hydrostatic Line

The reported coordinates were acquired from consumer grade GPS equipment and are only approximate locations. The coordinates should not be used for design purposes.



ENGEO Inc.

Job No: 16-56101
 Date: 12:23:16 09:40
 Site: Hayward, CA

Sounding: CPT-02
 Cone: 443:T1500F15U500

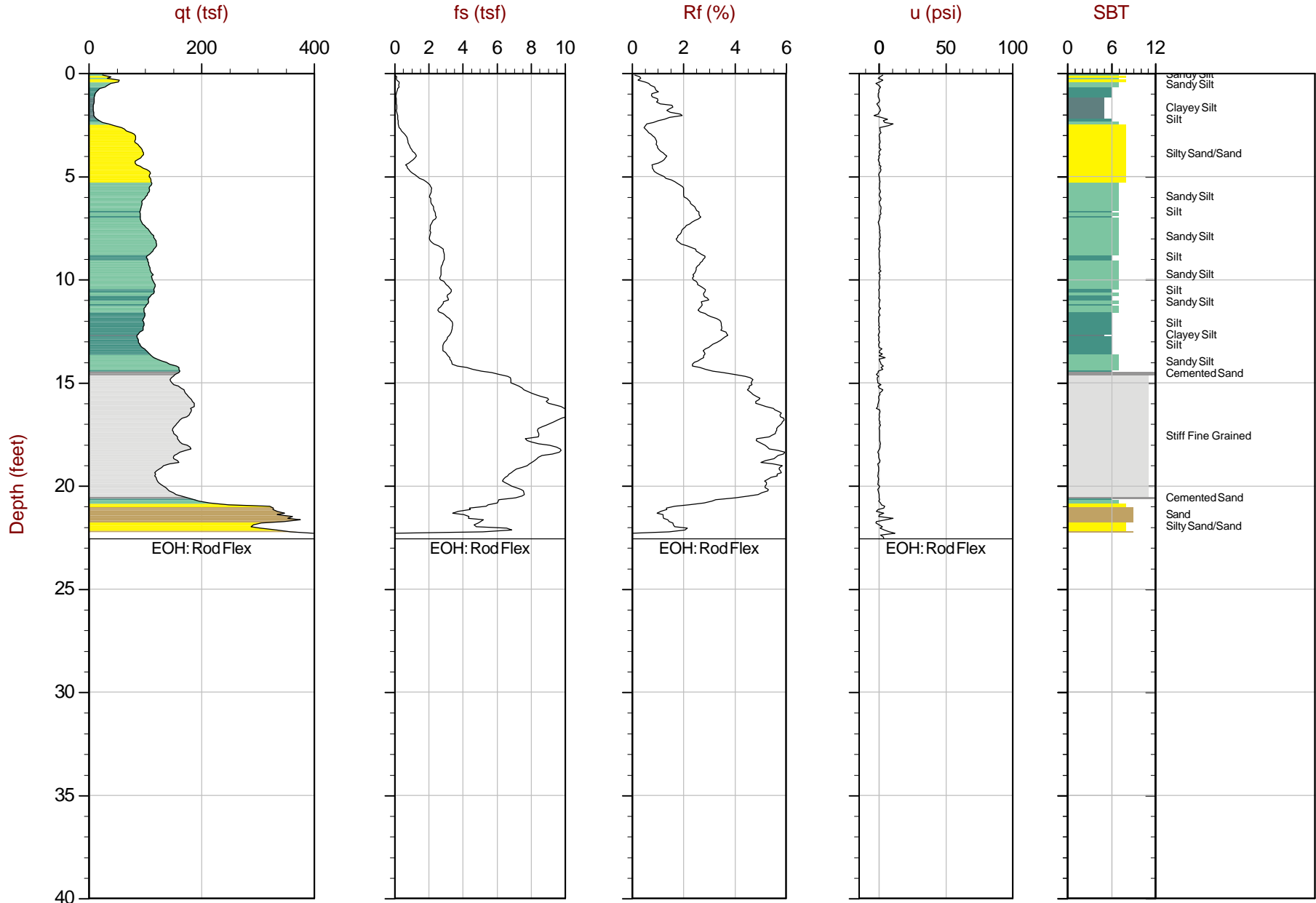

Max Depth: 6.875 m / 22.56 ft
 Depth Inc: 0.025 m / 0.082 ft
 Avg Int: Every Point

File: 16-56101_CP02.COR
 Unit Wt: SBT Zones

SBT: Robertson and Campanella, 1986
 Coords: UTM Zone 10N: 4170580m E: 581498m
 Page No: 1 of 1

● Equilibrium Pore Pressure (Ueq)
 ● Assumed Ueq
 ◀ Dissipation, Ueq achieved
 ◀ Dissipation, Ueq not achieved
 — Hydrostatic Line
 The reported coordinates were acquired from consumer grade GPS equipment and are only approximate locations. The coordinates should not be used for design purposes.



ENGEO Inc.

Job No: 16-56101
 Date: 12:23:16 10:14
 Site: Hayward, CA

Sounding: CPT-03
 Cone: 443:T1500F15U500

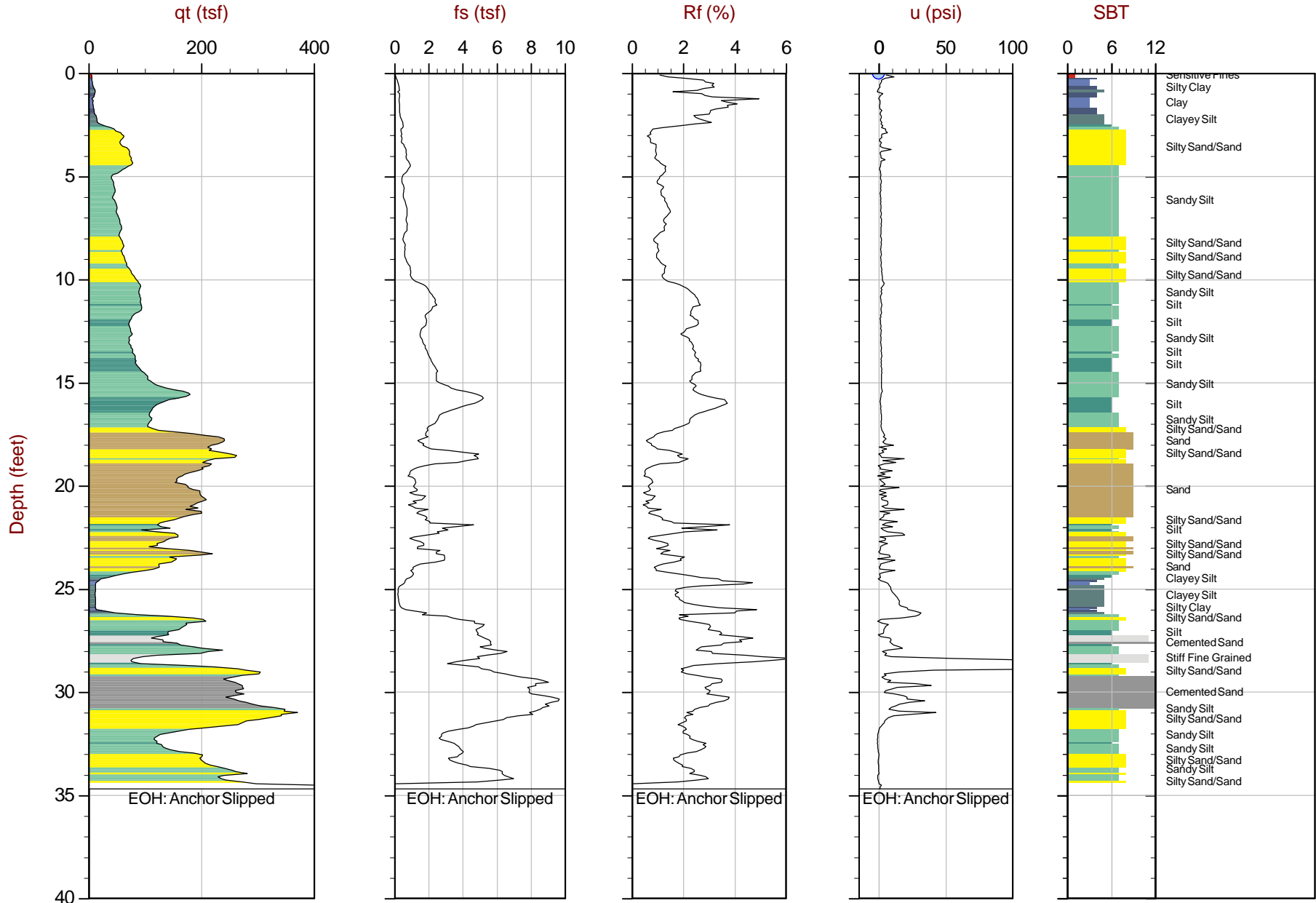

Max Depth: 10.575 m / 34.69 ft
 Depth Inc: 0.025 m / 0.082 ft
 Avg Int: Every Point

File: 16-56101_CP03.COR
 Unit Wt: SBT Zones

SBT: Robertson and Campanella, 1986
 Coords: UTM Zone 10N: 4170567m E: 581451m
 Page No: 1 of 1

● Equilibrium Pore Pressure (Ueq)
 ● Assumed Ueq
 ◀ Dissipation, Ueq achieved
 ◀ Dissipation, Ueq not achieved
 — Hydrostatic Line

The reported coordinates were acquired from consumer grade GPS equipment and are only approximate locations. The coordinates should not be used for design purposes.



ENGEO Inc.

Job No: 16-56101
 Date: 12:23:16 11:01
 Site: Hayward, CA

Sounding: CPT-04
 Cone: 443:T1500F15U500

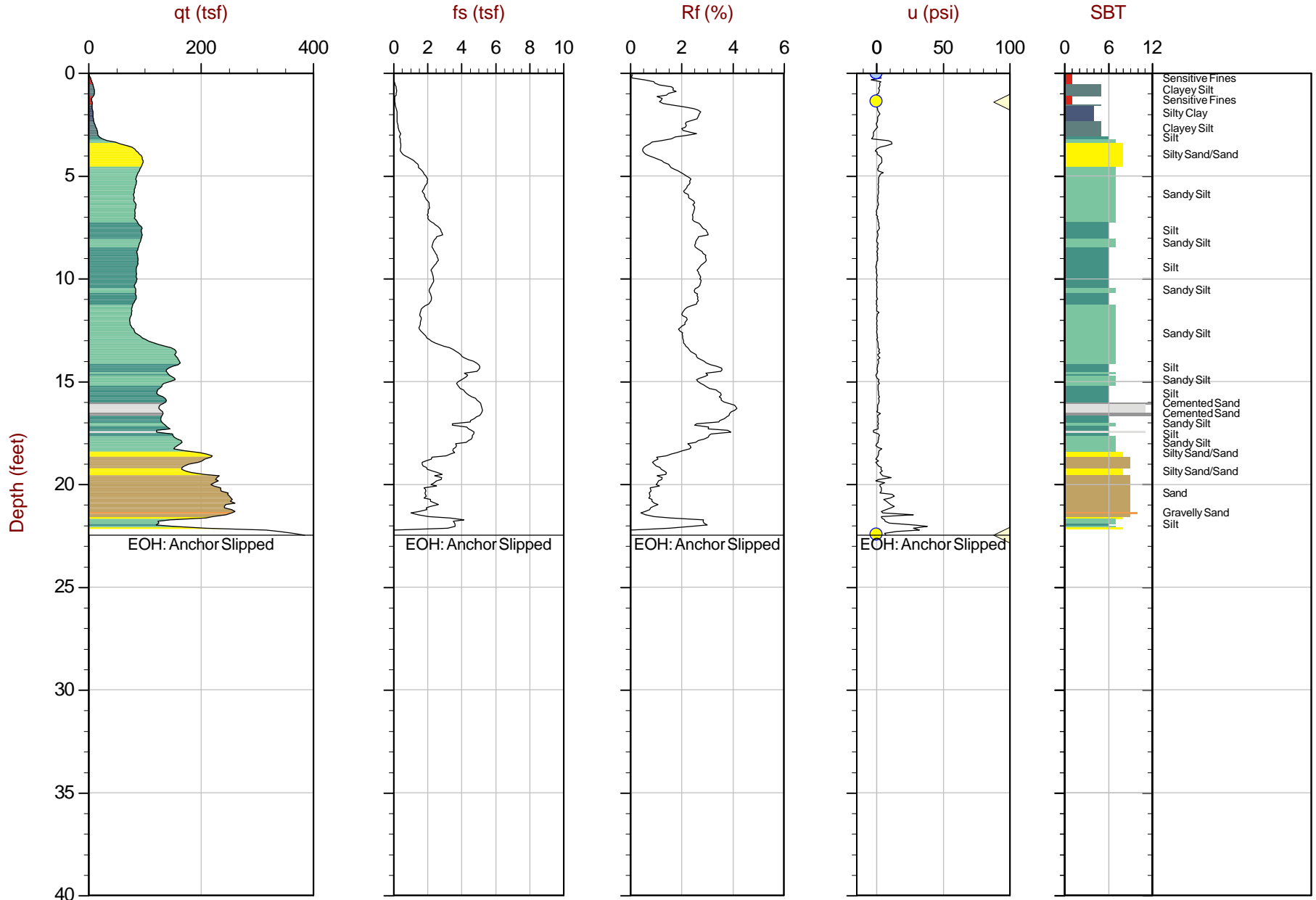

Max Depth: 6.850 m / 22.47 ft
 Depth Inc: 0.025 m / 0.082 ft
 Avg Int: Every Point

File: 16-56101_CP04.COR
 Unit Wt: SBT Zones

SBT: Robertson and Campanella, 1986
 Coords: UTM Zone 10N: 4170512m E: 581485m
 Page No: 1 of 1

● Equilibrium Pore Pressure (Ueq)
 ● Assumed Ueq
 ◀ Dissipation, Ueq achieved
 ◀ Dissipation, Ueq not achieved
 — Hydrostatic Line

The reported coordinates were acquired from consumer grade GPS equipment and are only approximate locations. The coordinates should not be used for design purposes.



ENGEO Inc.

Job No: 16-56101
 Date: 12:23:16 14:21
 Site: Hayward, CA

Sounding: CPT-05
 Cone: 443:T1500F15U500

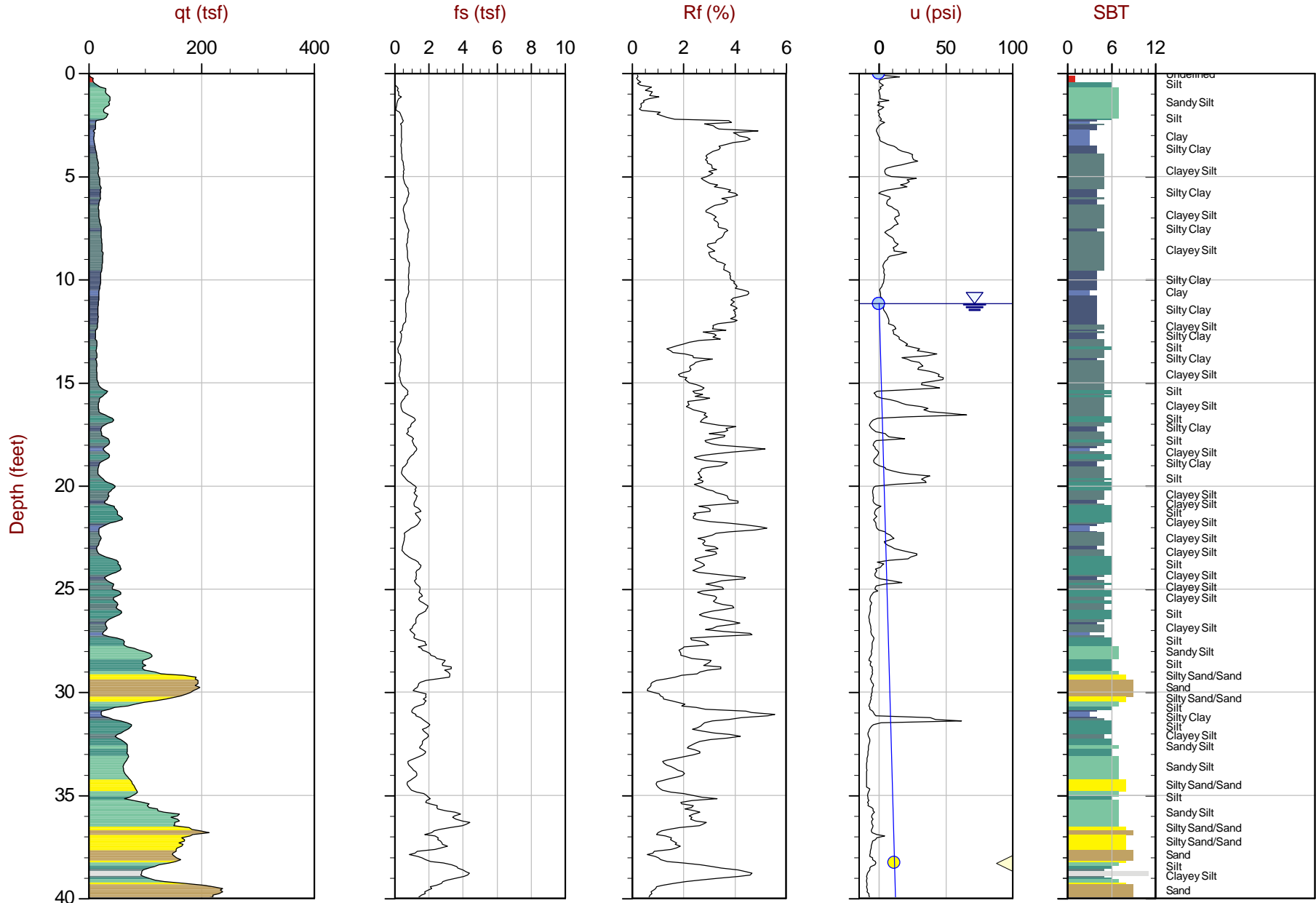

Max Depth: 13.900 m / 45.60 ft
 Depth Inc: 0.025 m / 0.082 ft
 Avg Int: Every Point

File: 16-56101_CP05.COR
 Unit Wt: SBT Zones

SBT: Robertson and Campanella, 1986
 Coords: UTM Zone 10N: 4170474m E: 581576m
 Page No: 1 of 2

● Equilibrium Pore Pressure (Ueq)
 ● Assumed Ueq
 ◀ Dissipation, Ueq achieved
 ◀ Dissipation, Ueq not achieved
 — Hydrostatic Line

The reported coordinates were acquired from consumer grade GPS equipment and are only approximate locations. The coordinates should not be used for design purposes.



ENGEO Inc.

Job No: 16-56101
 Date: 12:23:16 14:21
 Site: Hayward, CA

Sounding: CPT-05
 Cone: 443:T1500F15U500

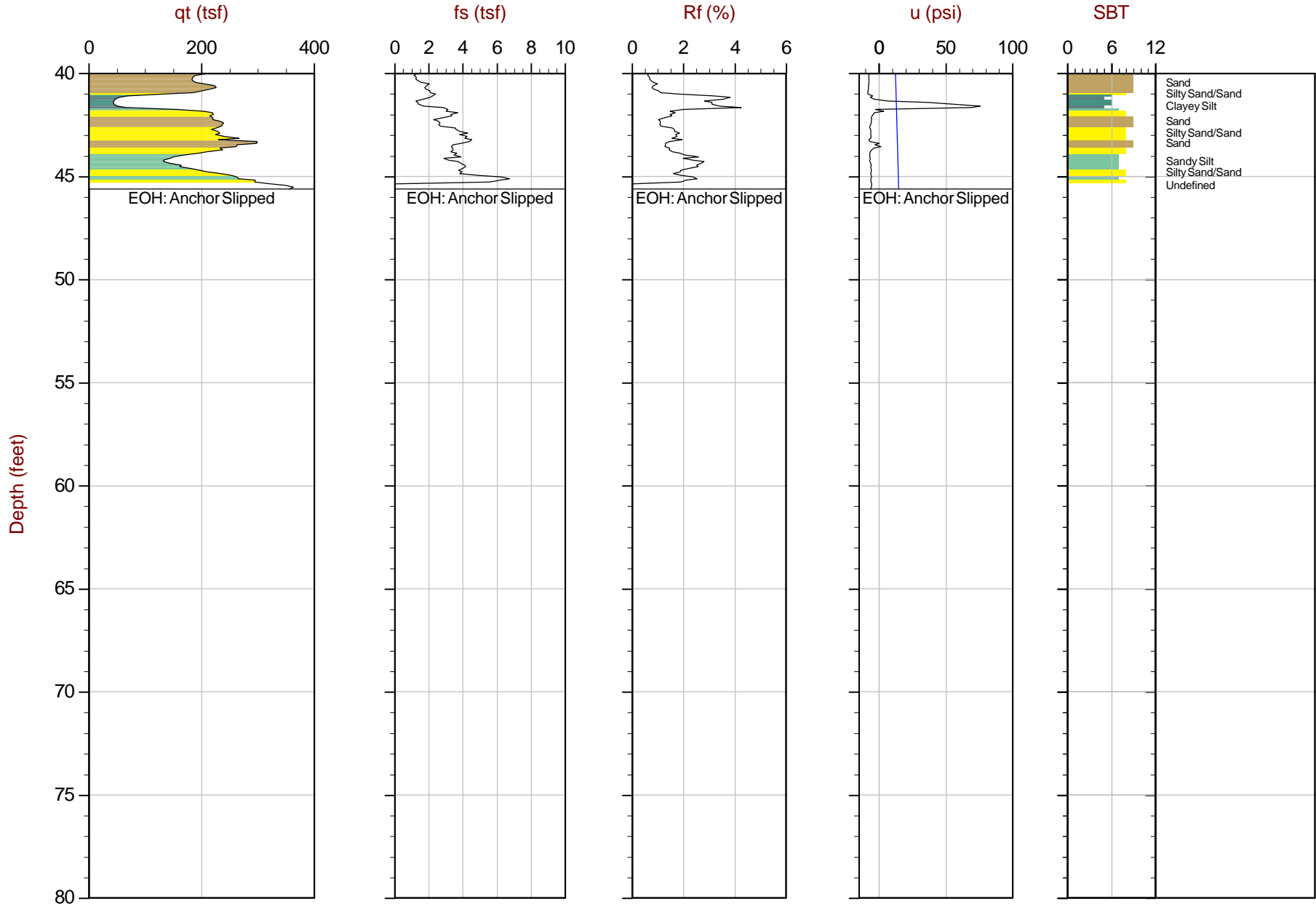

Max Depth: 13.900 m / 45.60 ft
 Depth Inc: 0.025 m / 0.082 ft
 Avg Int: Every Point

File: 16-56101_CP05.COR
 Unit Wt: SBT Zones

SBT: Robertson and Campanella, 1986
 Coords: UTM Zone 10N: 4170474mE: 581576m
 Page No: 2 of 2

● Equilibrium Pore Pressure (Ueq)
 ● Assumed Ueq
 ◀ Dissipation, Ueq achieved
 ◀ Dissipation, Ueq not achieved
 — Hydrostatic Line
 The reported coordinates were acquired from consumer grade GPS equipment and are only approximate locations. The coordinates should not be used for design purposes.

Advanced Cone Penetration Test Plots with I_c , $S_u(N_{kt})$ and $N_{1(60)}$



ENGEO Inc.

Job No: 16-56101
 Date: 12:23:16 08:32
 Site: Hayward, CA

Sounding: CPT-01
 Cone: 443:T1500F15U500

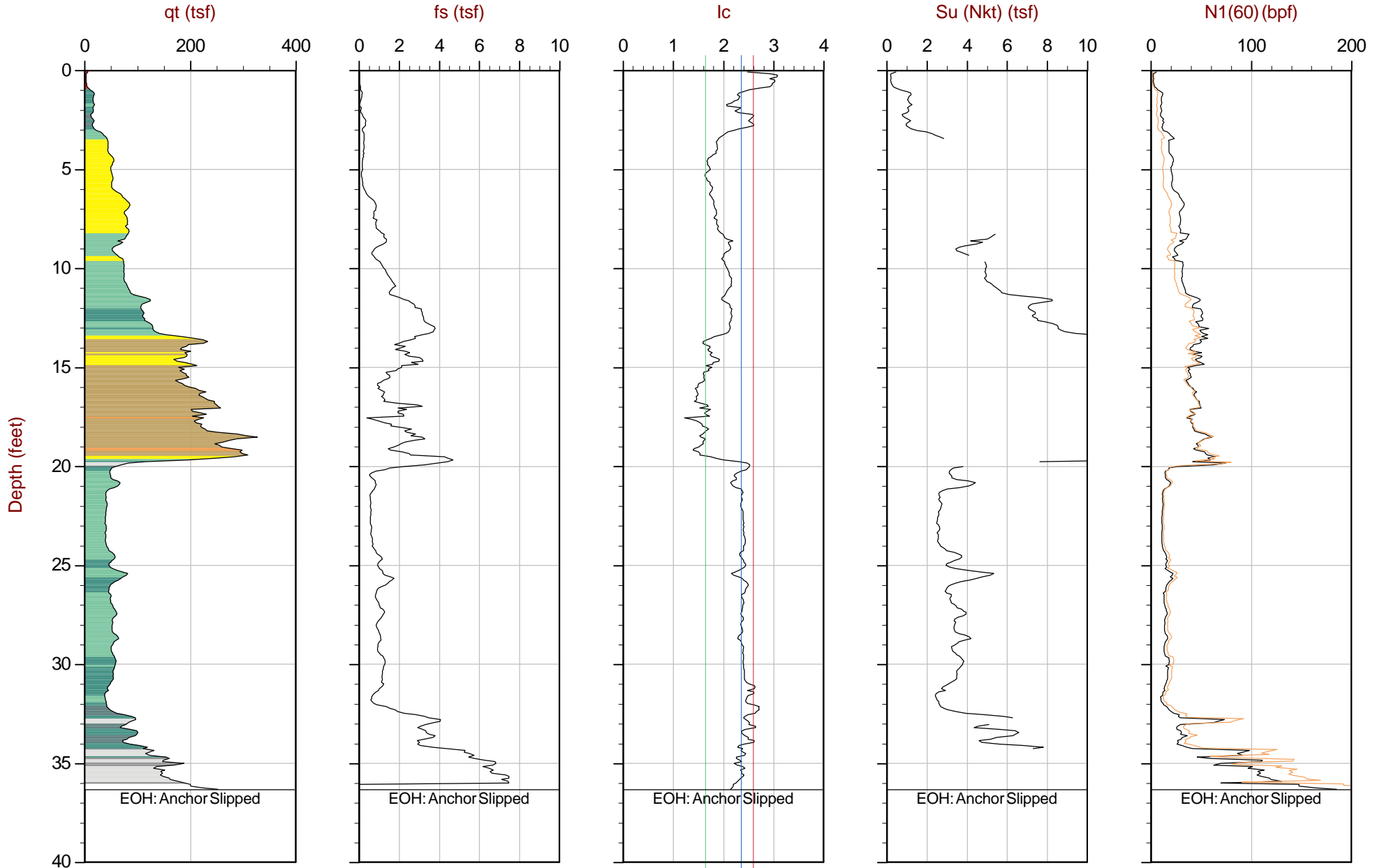

Max Depth: 11.075 m / 36.33 ft
 Depth Inc: 0.025 m / 0.082 ft
 Avg Int: EveryPoint

File: 16-56101_CP01.COR
 Unit Wt: SBT Zones
 Su Nkt: 15.0

SBT: Robertson and Campanella, 1986
 Coords: UTM Zone 10N: 4170632m E: 581551m
 Page No: 1 of 1

— N(60) (bpf)

The reported coordinates were acquired from consumer grade GPS equipment and are only approximate locations. The coordinates should not be used for design purposes.



ENGEO Inc.

Job No: 16-56101
 Date: 12:23:16 09:40
 Site: Hayward, CA

Sounding: CPT-02
 Cone: 443:T1500F15U500

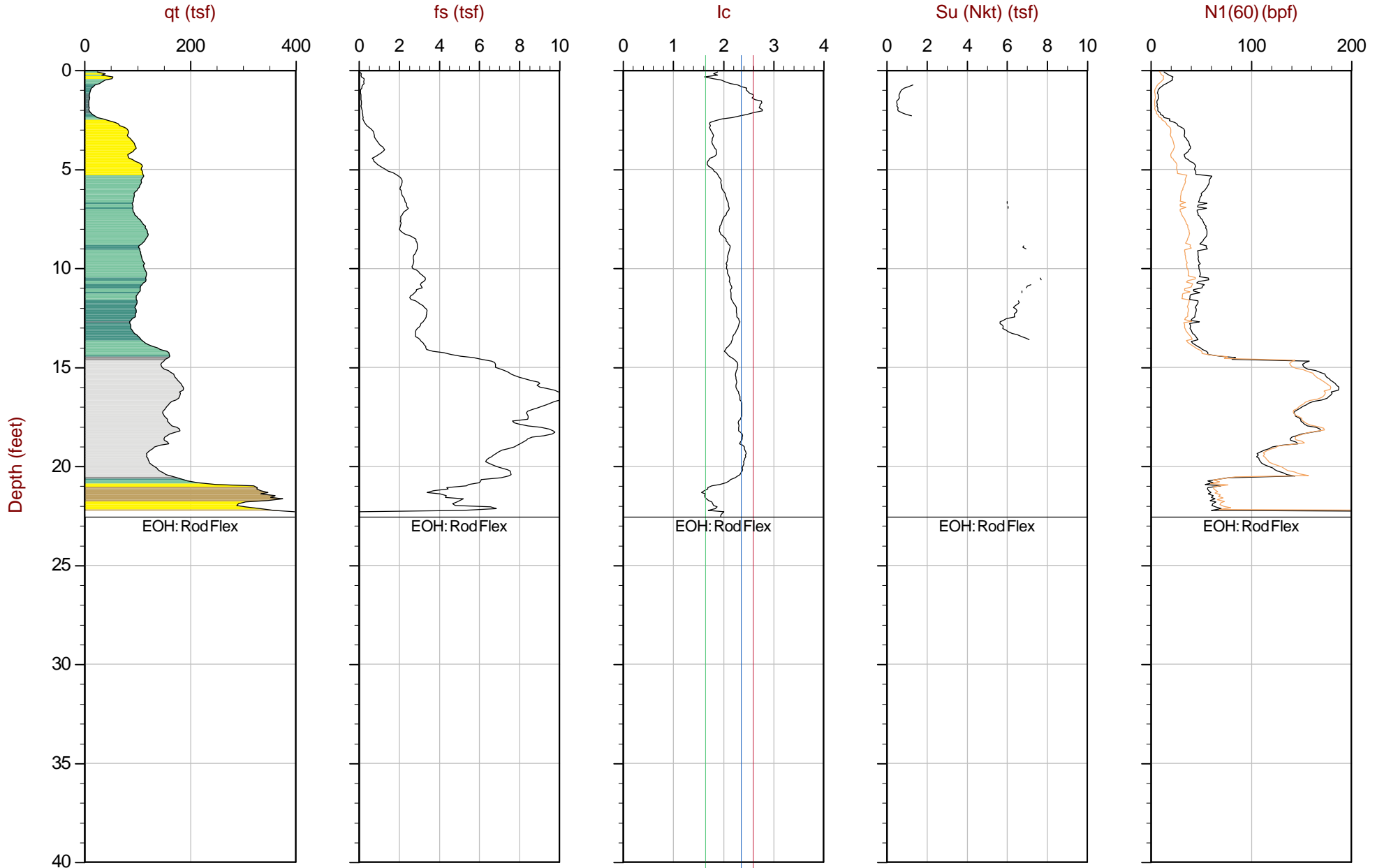

Max Depth: 6.875 m / 22.56 ft
 Depth Inc: 0.025 m / 0.082 ft
 Avg Int: EveryPoint

File: 16-56101_CP02.COR
 Unit Wt: SBT Zones
 Su Nkt: 15.0

SBT: Robertson and Campanella, 1986
 Coords: UTM Zone 10N: 4170580m E: 581498m
 Page No: 1 of 1

— N(60) (bpf)



ENGEO Inc.

Job No: 16-56101
 Date: 12:23:16 10:14
 Site: Hayward, CA

Sounding: CPT-03
 Cone: 443:T1500F15U500

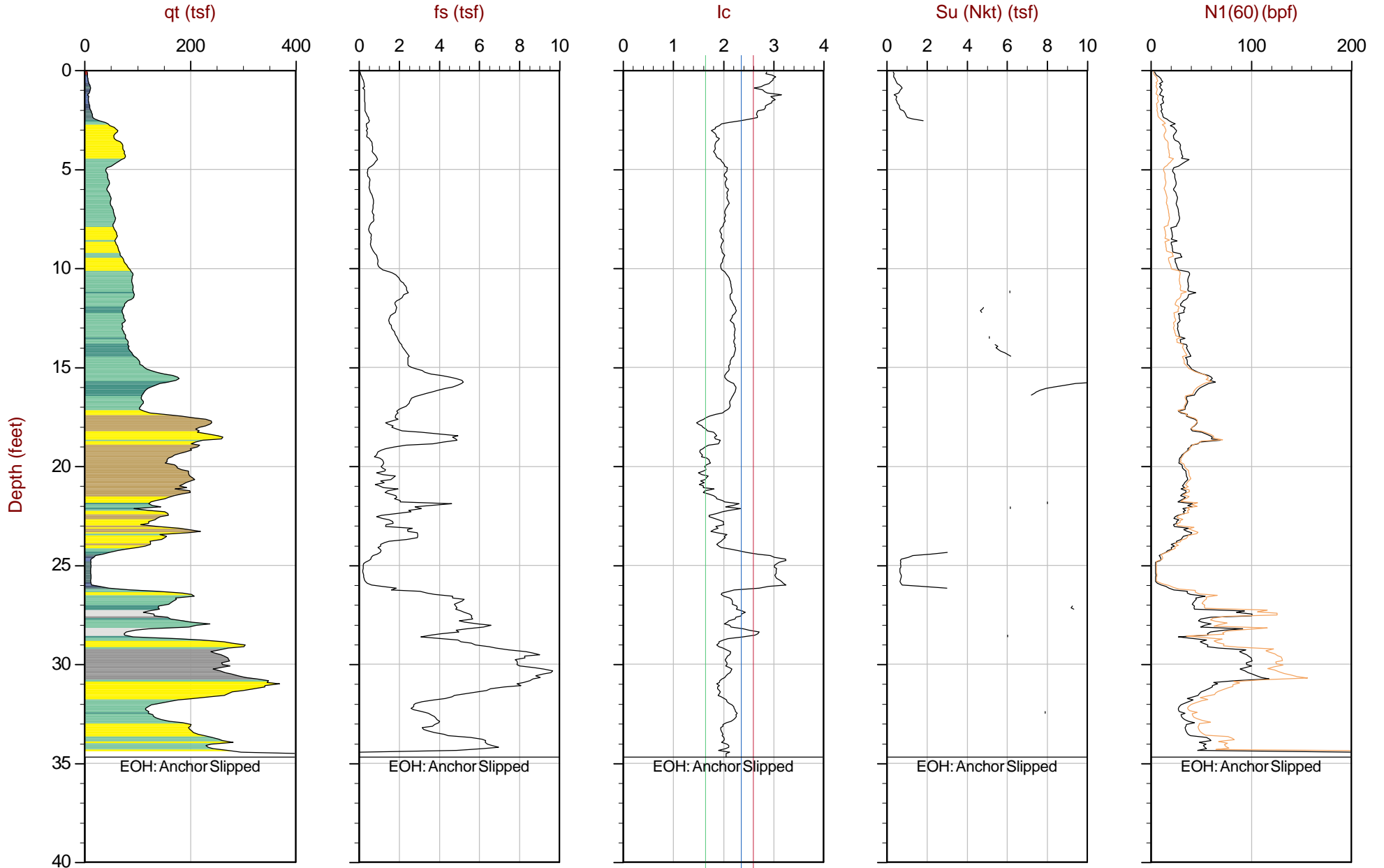

Max Depth: 10.575 m / 34.69 ft
 Depth Inc: 0.025 m / 0.082 ft
 Avg Int: EveryPoint

File: 16-56101_CP03.COR
 Unit Wt: SBT Zones
 Su Nkt: 15.0

SBT: Robertson and Campanella, 1986
 Coords: UTM Zone 10N: 4170567m E: 581451m
 Page No: 1 of 1

— N(60) (bpf)

The reported coordinates were acquired from consumer grade GPS equipment and are only approximate locations. The coordinates should not be used for design purposes.



ENGEO Inc.

Job No: 16-56101
 Date: 12:23:16 11:01
 Site: Hayward, CA

Sounding: CPT-04
 Cone: 443:T1500F15U500

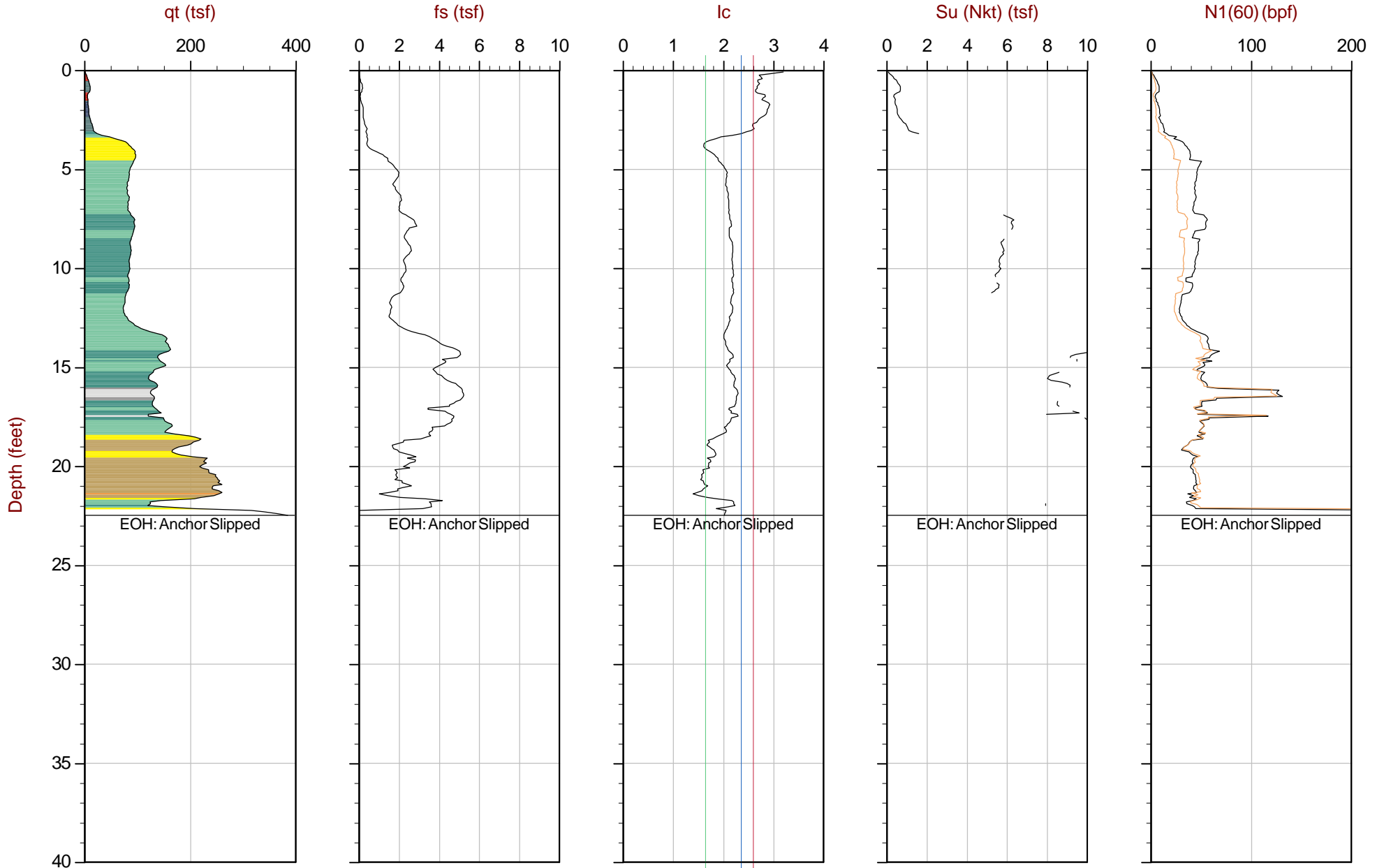

Max Depth: 6.850 m / 22.47 ft
 Depth Inc: 0.025 m / 0.082 ft
 Avg Int: EveryPoint

File: 16-56101_CP04.COR
 Unit Wt: SBT Zones
 Su Nkt: 15.0

SBT: Robertson and Campanella, 1986
 Coords: UTM Zone 10N: 4170512m E: 581485m
 Page No: 1 of 1

— N(60) (bpf)



ENGEO Inc.

Job No: 16-56101
 Date: 12:23:16 14:21
 Site: Hayward, CA

Sounding: CPT-05
 Cone: 443:T1500F15U500

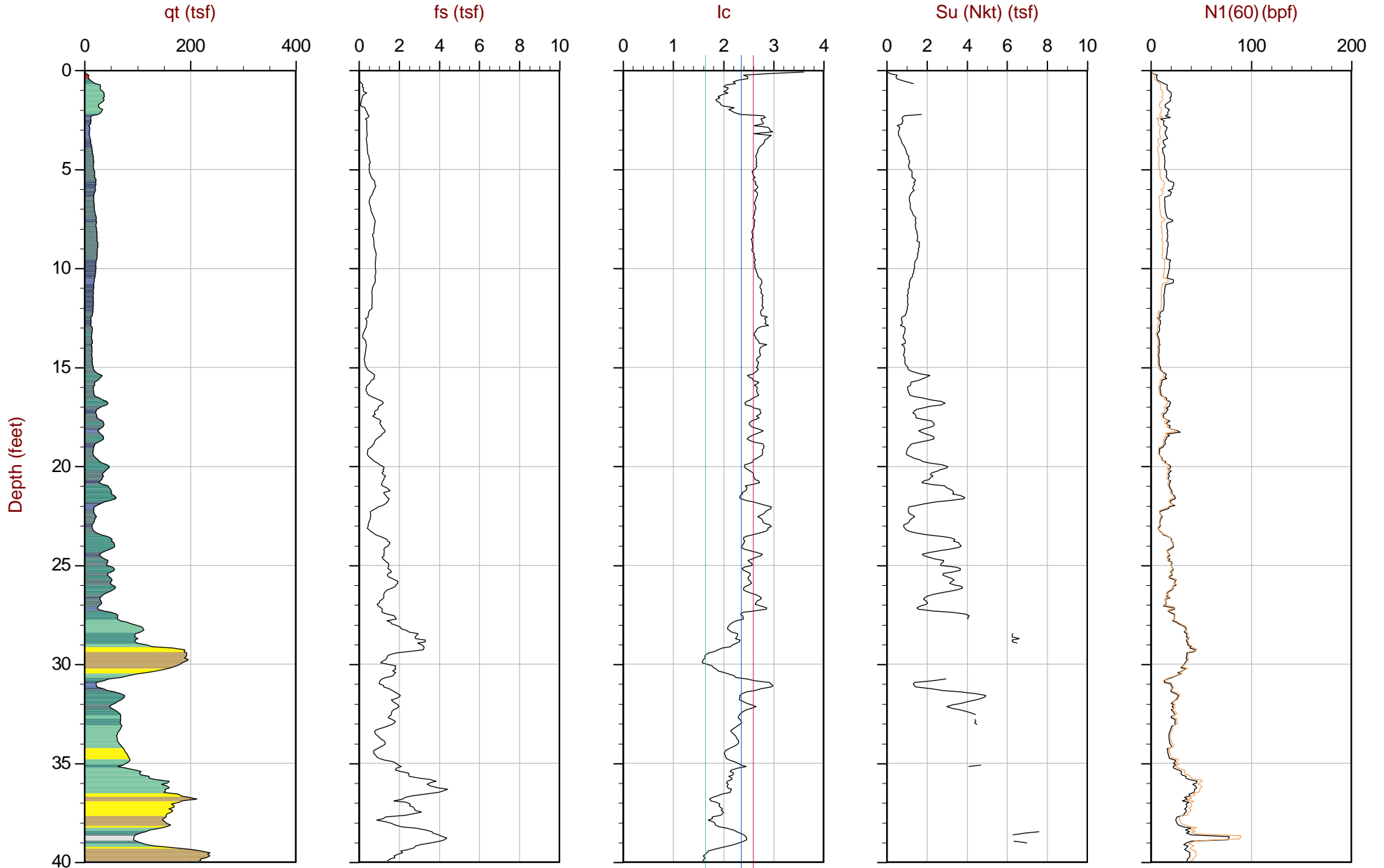

Max Depth: 13.900 m / 45.60 ft
 Depth Inc: 0.025 m / 0.082 ft
 Avg Int: EveryPoint

File: 16-56101_CP05.COR
 Unit Wt: SBT Zones
 Su Nkt: 15.0

SBT: Robertson and Campanella, 1986
 Coords: UTM Zone 10N: 4170474m E: 581576m
 Page No: 1 of 2

— N(60) (bpf)

The reported coordinates were acquired from consumer grade GPS equipment and are only approximate locations. The coordinates should not be used for design purposes.



ENGEO Inc.

Job No: 16-56101
 Date: 12:23:16 14:21
 Site: Hayward, CA

Sounding: CPT-05
 Cone: 443:T1500F15U500

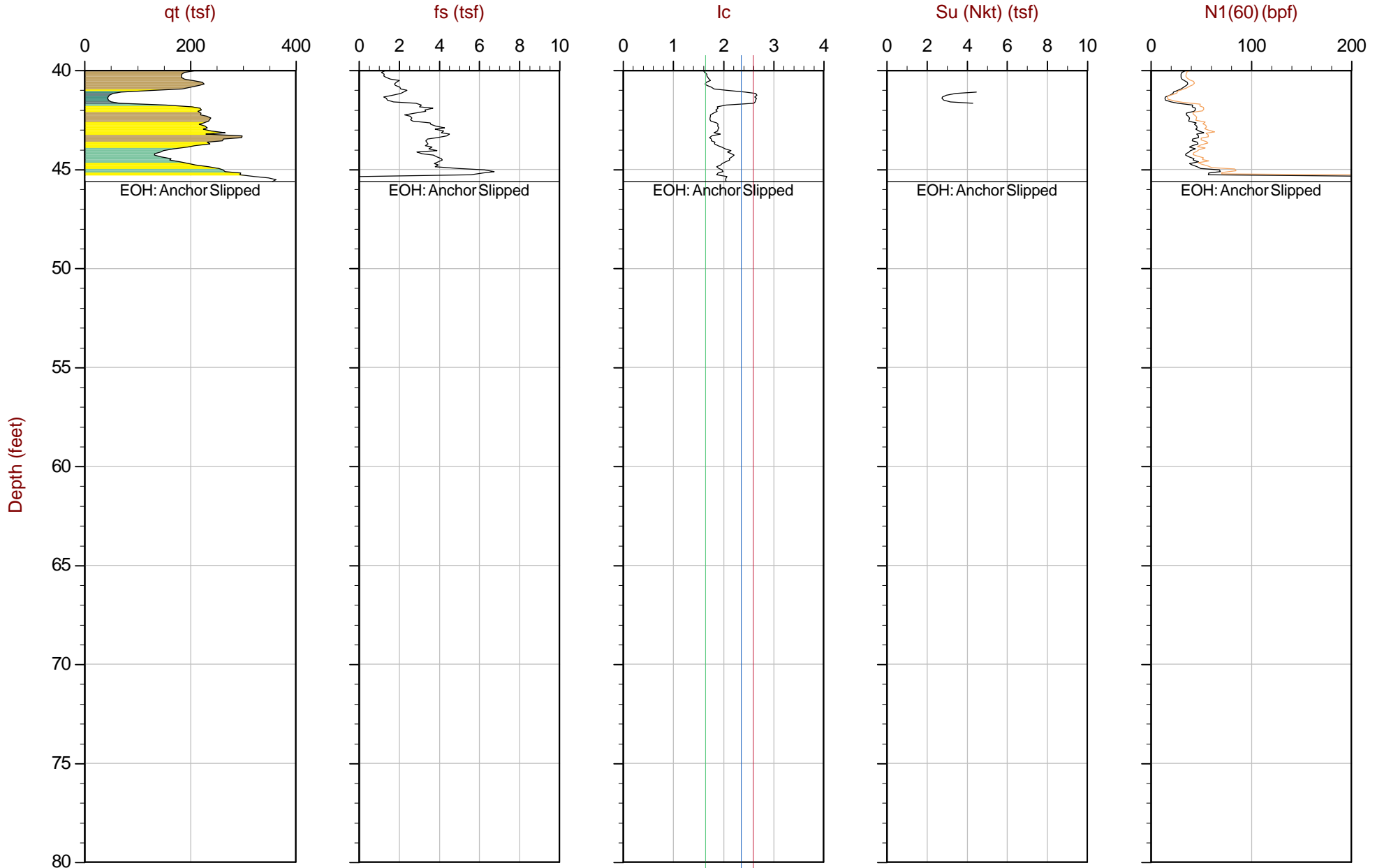

Max Depth: 13.900 m / 45.60 ft
 Depth Inc: 0.025 m / 0.082 ft
 Avg Int: EveryPoint

File: 16-56101_CP05.COR
 Unit Wt: SBT Zones
 Su Nkt: 15.0

SBT: Robertson and Campanella, 1986
 Coords: UTM Zone 10N: 4170474m E: 581576m
 Page No: 2 of 2

— N(60) (bpf)

The reported coordinates were acquired from consumer grade GPS equipment and are only approximate locations. The coordinates should not be used for design purposes.

Pore Pressure Dissipation Summary and Pore Pressure Dissipation Plots



Job No: 16-56101
 Client: ENGEO Inc.
 Project: B Street Project, Hayward, CA
 Start Date: 23-Dec-2016
 End Date: 23-Dec-2016

CPT_u PORE PRESSURE DISSIPATION SUMMARY

Sounding ID	File Name	Cone Area (cm ²)	Duration (s)	Test Depth (ft)	Estimated Equilibrium Pore Pressure U _{eq} (psi)	Calculated Phreatic Surface (ft)
CPT-01	16-56101_CP01	15	560	36.335	Not Achieved	
CPT-04	16-56101_CP04	15	320	1.394	0.00	
CPT-04	16-56101_CP04	15	200	22.473	0.00	
CPT-05	16-56101_CP05	15	425	38.303	11.76	3.4



ENGEO Inc.

Job No: 16-56101
Date: 12/23/2016 11:01
Site: Hayward, CA

Sounding: CPT-04
Cone: 443:T1500F15U500
Cone Area: 15 sq cm

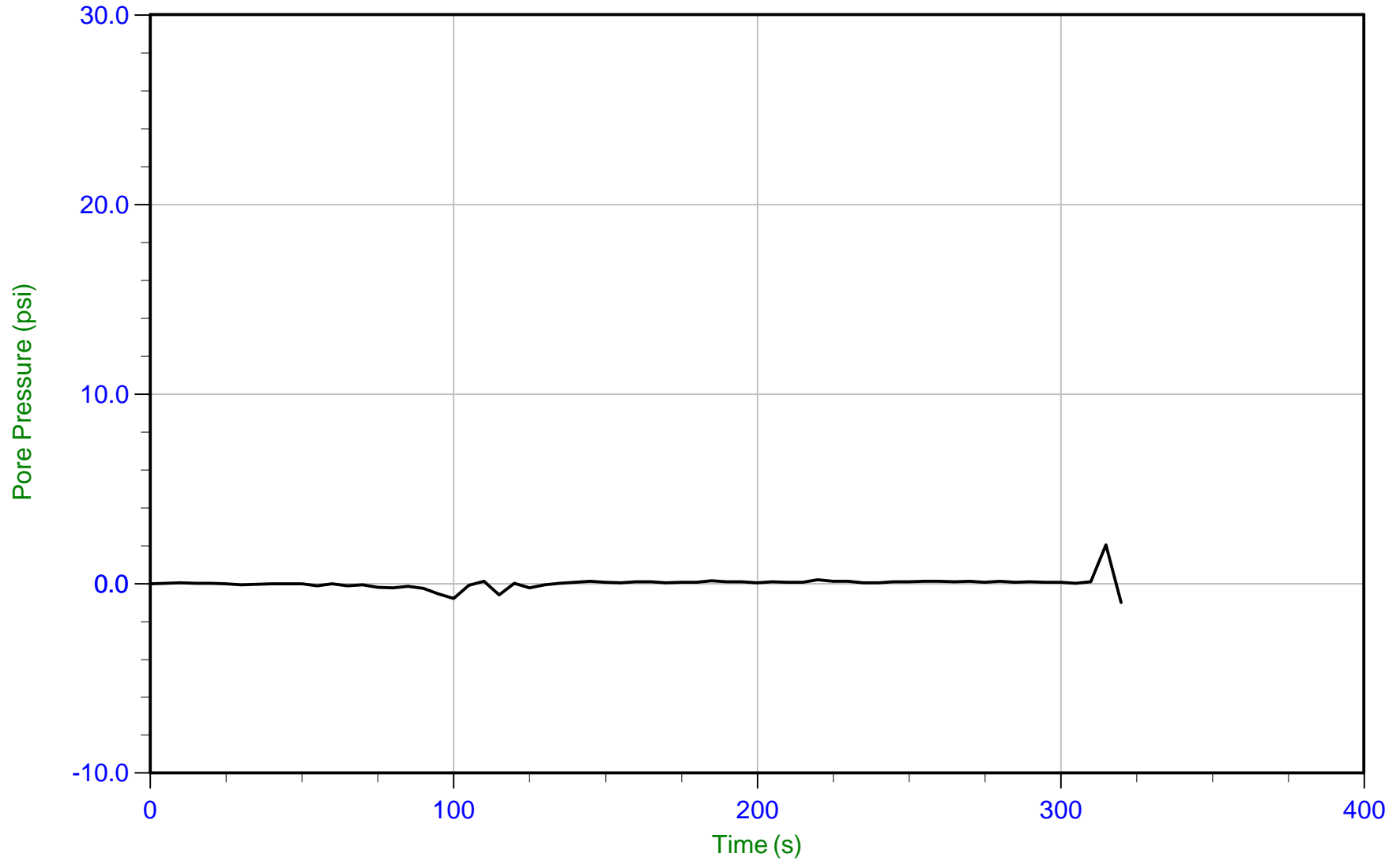

Trace Summary: Filename: 16-56101_CP04.PPD U Min: -1.0 psi
 Depth: 0.425 m / 1.394 ft U Max: 2.0 psi
 Duration: 320.0 s



ENGEO Inc.

Job No: 16-56101
Date: 12/23/2016 11:01
Site: Hayward, CA

Sounding: CPT-04
Cone: 443:T1500F15U500
Cone Area: 15 sq cm

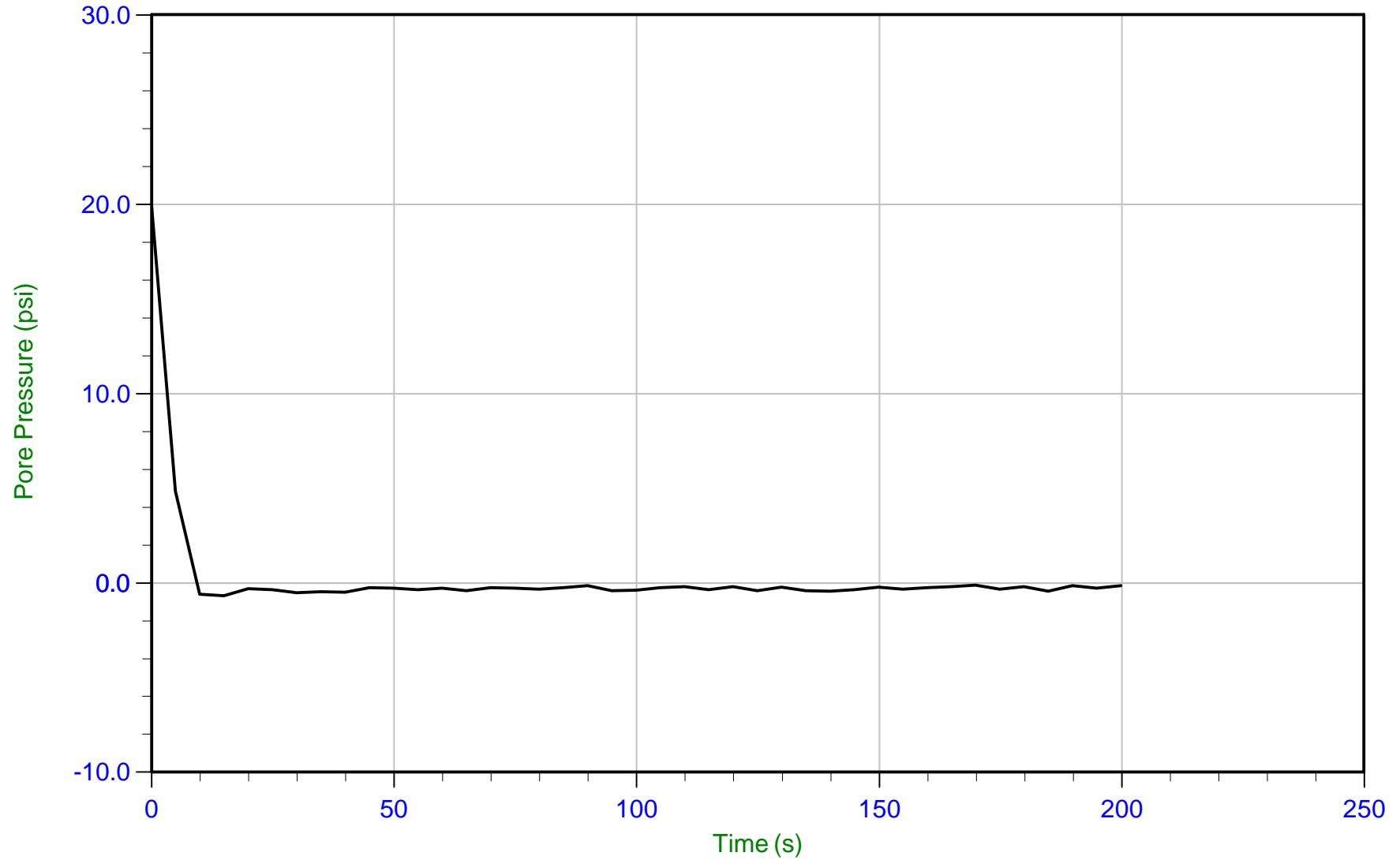

Trace Summary: Filename: 16-56101_CP04.PPD U Min: -0.7 psi
 Depth: 6.850 m / 22.473 ft U Max: 19.9 psi
 Duration: 200.0 s



ENGEO Inc.

Job No: 16-56101
 Date: 12/23/2016 14:21
 Site: Hayward, CA

Sounding: CPT-05
 Cone: 443:T1500F15U500
 Cone Area: 15 sq cm

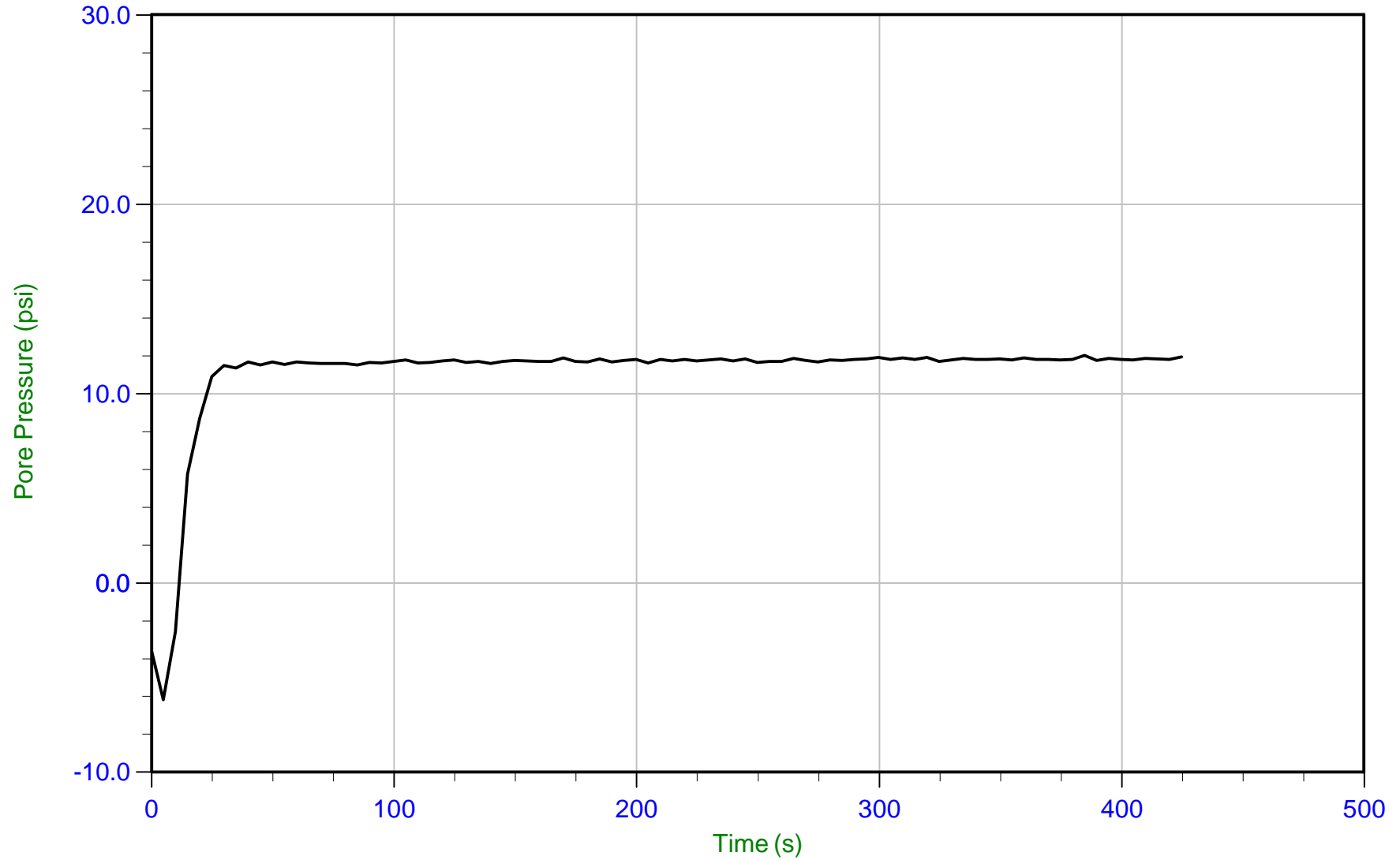

Trace Summary:	Filename: 16-56101_CP05.PPD	U Min: -6.2 psi	WT: 3.408 m / 11.181 ft
	Depth: 11.675 m / 38.303 ft	U Max: 12.0 psi	Ueq: 11.8 psi
	Duration: 425.0 s		



APPENDIX B

LABORATORY TEST DATA

Particle Size Distribution Report

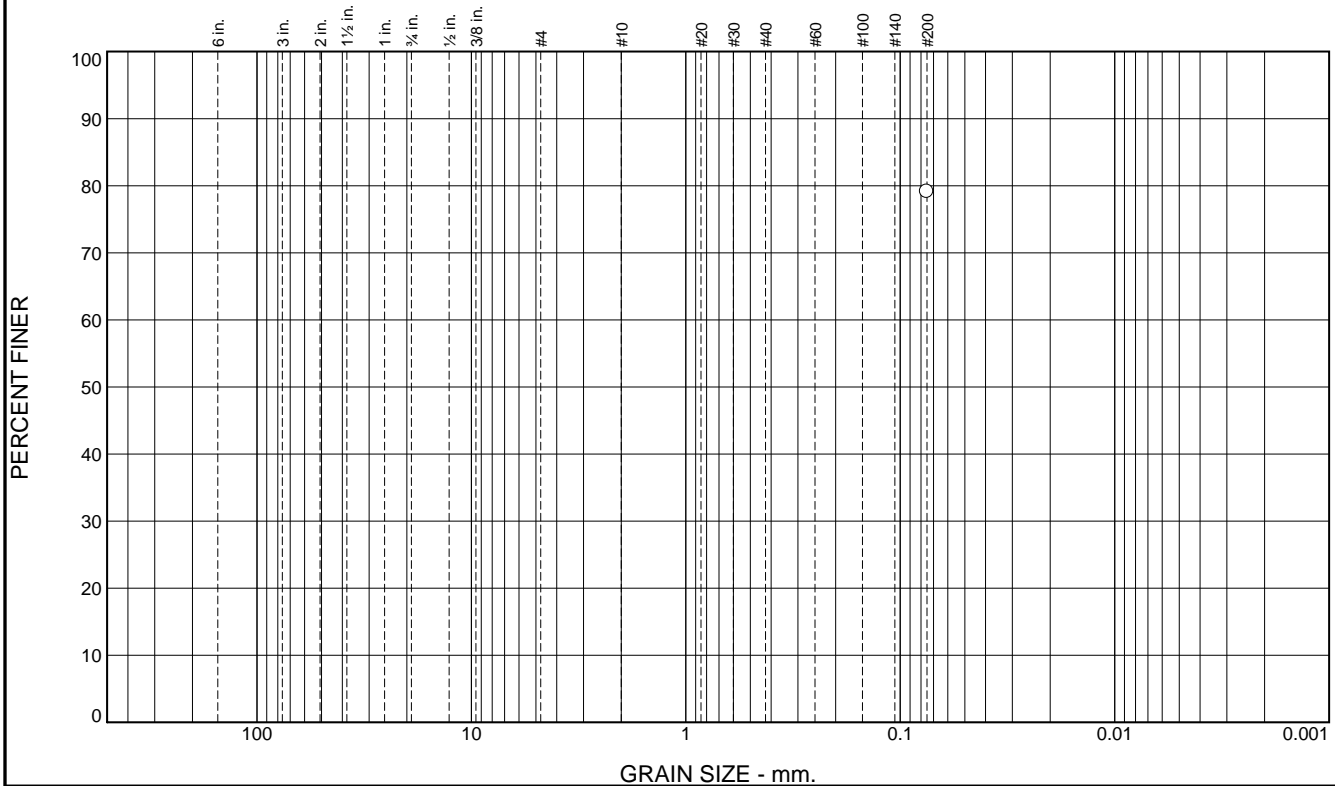

% +75mm	% Gravel		% Sand			% Fines	
	Coarse	Fine	Coarse	Medium	Fine	Silt	Clay
						79.1	

SIEVE SIZE	PERCENT FINER	SPEC.* PERCENT	PASS? (X=NO)
#200	79.1		

Soil Description
See exploration logs

Atterberg Limits
 PL= 16 LL= 35 PI= 19

Coefficients
 D₈₅= D₆₀=
 D₅₀= D₁₅=
 D₁₀= C_u= C_c=

Classification
 USCS= AASHTO=

Remarks
 Grain Size: ASTM D1140
 PI: ASTM D4318

* (no specification provided)

Sample Number: CPT-1 @ 2

Depth: 2.0-6.0 feet

Date: 12.30.16



Client: Dutra Enterprises, Inc.

Project: B Street Project

Project No: 13599.000.000

Tested By: T. Borde

Checked By: D. Seibold

Particle Size Distribution Report

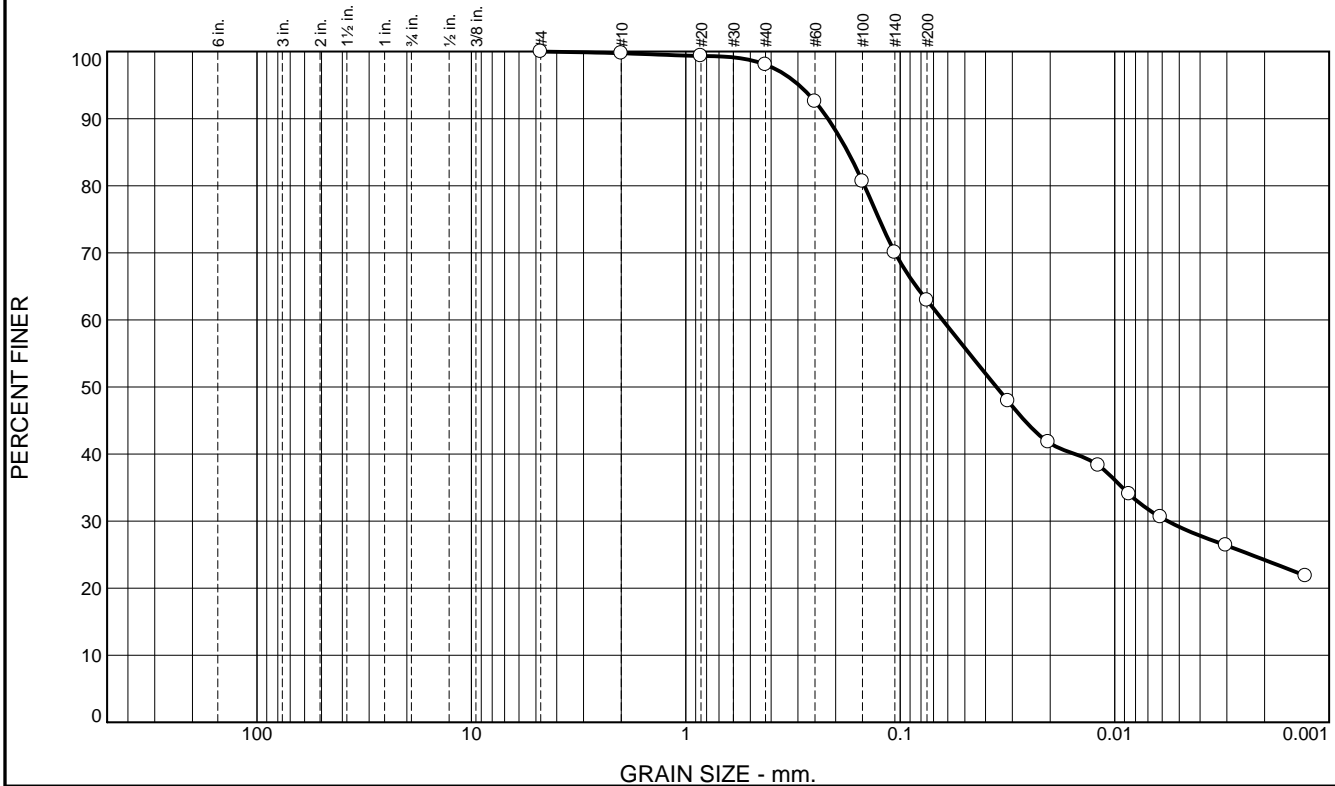

% +75mm	% Gravel		% Sand			% Fines	
	Coarse	Fine	Coarse	Medium	Fine	Silt	Clay
0.0	0.0	0.0	0.2	1.7	35.2	38.7	24.2

SIEVE SIZE	PERCENT FINER	SPEC.* PERCENT	PASS? (X=NO)
#4	100.0		
#10	99.8		
#20	99.4		
#40	98.1		
#60	92.6		
#100	80.6		
#140	70.0		
#200	62.9		
0.0314 mm.	47.9		
0.0204 mm.	41.8		
0.0119 mm.	38.3		
0.0086 mm.	34.0		
0.0061 mm.	30.6		
0.0030 mm.	26.4		
0.0013 mm.	21.8		

Soil Description

See exploration logs

Atterberg Limits

PL= 14 LL= 33 PI= 19

Coefficients

D₉₀= 0.2175 D₈₅= 0.1751 D₆₀= 0.0635
D₅₀= 0.0356 D₃₀= 0.0057 D₁₅=
D₁₀= C_u= C_c=

Classification

USCS= CL AASHTO= A-6(9)

Remarks

GS: ASTM D422
Silt/clay division of 0.002mm used
PI: ASTM D4318, Wet method; USCS: ASTM D2487

* (no specification provided)

Sample Number: CPT-1 @ 20-24

Depth: 20.0-24.0 feet

Date: 12/30/16



Client: Dutra Enterprises, Inc.

Project: B Street Project

Project No: 13599.000.000

Tested By: G. Criste

Checked By: D. Seibold

Particle Size Distribution Report

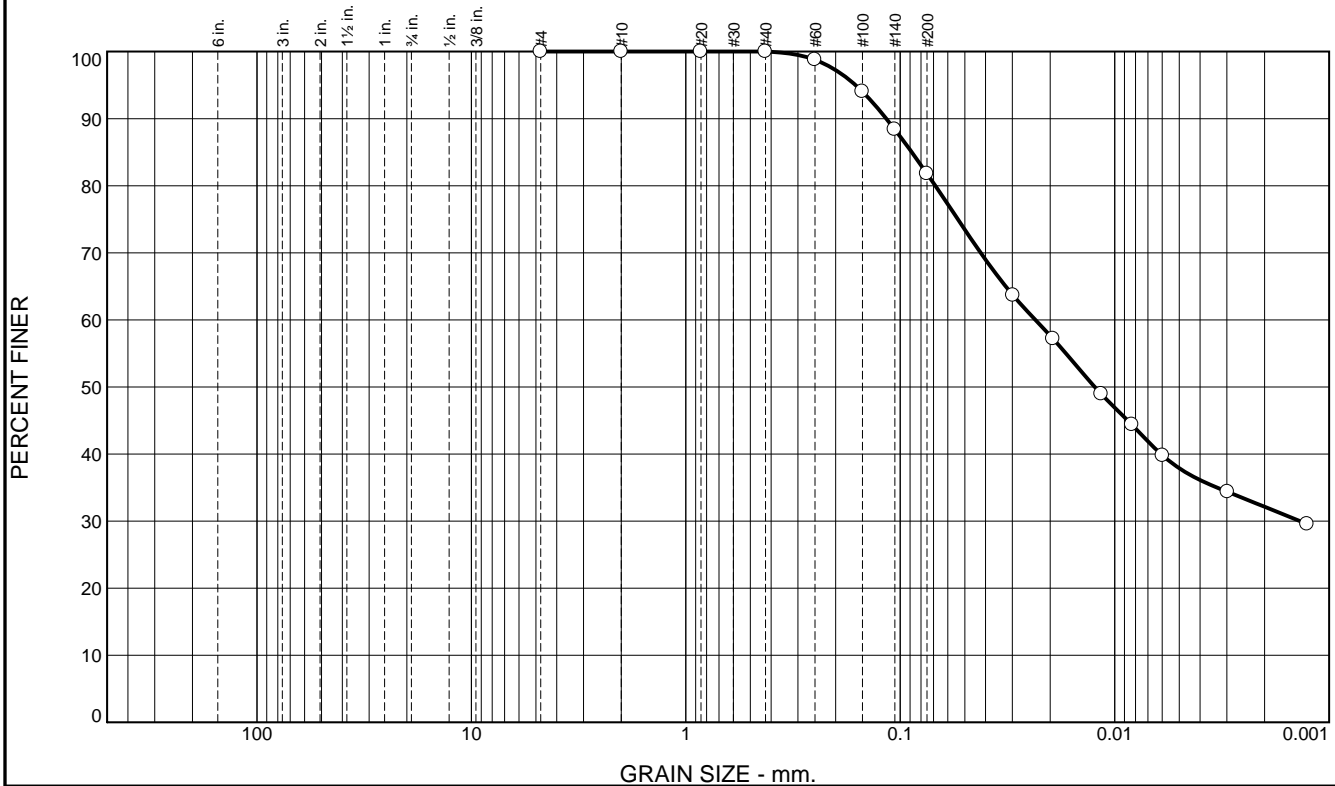

% +75mm	% Gravel		% Sand			% Fines	
	Coarse	Fine	Coarse	Medium	Fine	Silt	Clay
0.0	0.0	0.0	0.0	0.0	18.2	49.7	32.1

SIEVE SIZE	PERCENT FINER	SPEC.* PERCENT	PASS? (X=NO)
#4	100.0		
#10	100.0		
#20	100.0		
#40	100.0		
#60	98.8		
#100	94.0		
#140	88.4		
#200	81.8		
0.0298 mm.	63.6		
0.0194 mm.	57.2		
0.0115 mm.	48.9		
0.0083 mm.	44.4		
0.0060 mm.	39.8		
0.0030 mm.	34.4		
0.0013 mm.	29.6		

Soil Description

See exploration logs

Atterberg Limits

PL= 15 LL= 36 PI= 21

Coefficients

D₉₀= 0.1162 D₈₅= 0.0884 D₆₀= 0.0234
D₅₀= 0.0124 D₃₀= 0.0014 D₁₅=
D₁₀= C_u= C_c=

Classification

USCS= CL AASHTO= A-6(16)

Remarks

GS: ASTM D422
Silt/clay division of 0.002mm used
PI: ASTM D4318, Wet method; USCS: ASTM D2487

* (no specification provided)

Sample Number: CPT-3 @ 10-12

Depth: 10.0-12.0 feet

Date: 12/30/16



Client: Dutra Enterprises, Inc.

Project: B Street Project

Project No: 13599.000.000

Tested By: G. Criste

Checked By: D. Seibold

LIQUID AND PLASTIC LIMITS TEST REPORT

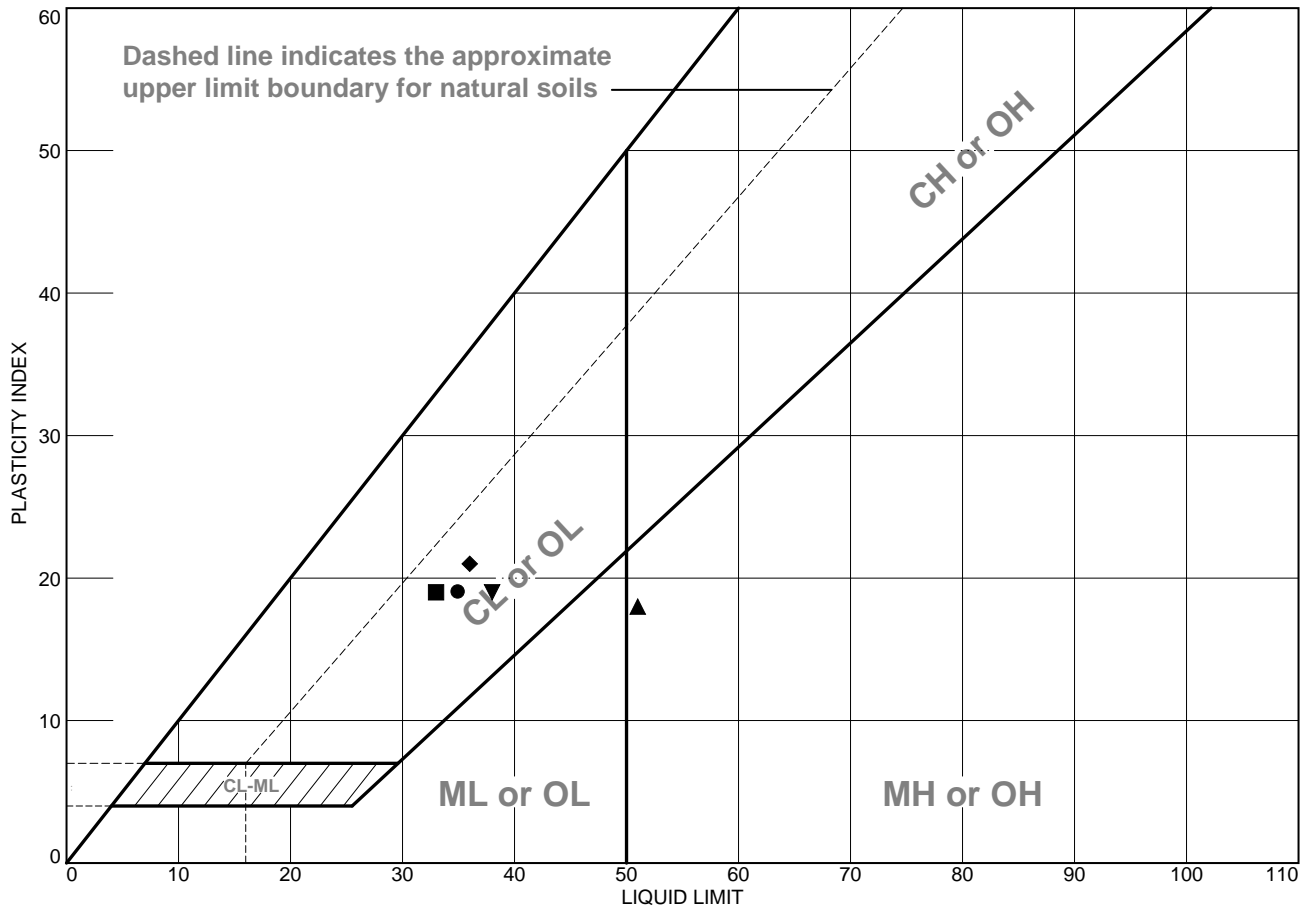

	MATERIAL DESCRIPTION	LL	PL	PI	%<#40	%<#200	USCS
●	See exploration logs	35	16	19		79.1	
■	See exploration logs	33	14	19	98.1	62.9	CL
▲	See exploration logs	51	33	18			
◆	See exploration logs	36	15	21	100.0	81.8	CL
▼	See exploration logs	38	19	19			

Project No. 13599.000.000 **Client:** Dutra Enterprises, Inc.
Project: B Street Project

● **Depth:** 2.0-6.0 feet **Sample Number:** CPT-1 @ 2-6
 ■ **Depth:** 20.0-24.0 feet **Sample Number:** CPT-1 @ 20-24
 ▲ **Depth:** Surface **Sample Number:** CPT-2 @ Surface
 ◆ **Depth:** 10.0-12.0 feet **Sample Number:** CPT-3 @ 10-12
 ▼ **Depth:** Surface **Sample Number:** CPT-5 @ Surface

Remarks:
 ● PI: ASTM D4318, Wet method
 GS: ASTM D1140
 ■ PI: ASTM D4318
 ▲ ASTM D4318, Wet method
 ◆ PI: ASTM D4318, Wet method
 GS: ASTM D422
 USCS: ASTM D2487
 ▼ ASTM D4318, Wet method



Tested By: G. Criste **Checked By:** T. Borde



APPENDIX C

LIQUEFACTION ANALYSIS



LIQUEFACTION ANALYSIS REPORT

Project title : B Street Project

Location : Hayward, California

CPT file : CPT-01

Input parameters and analysis data

Analysis method:	B&I (2014)	G.W.T. (in-situ):	20.00 ft	Use fill:	No	Clay like behavior applied:	Sands only
Fines correction method:	B&I (2014)	G.W.T. (earthq.):	20.00 ft	Fill height:	N/A	Limit depth applied:	No
Points to test:	Based on Ic value	Average results interval:	1	Fill weight:	N/A	Limit depth:	N/A
Earthquake magnitude M_w :	7.30	Ic cut-off value:	2.60	Trans. detect. applied:	Yes	MSF method:	Method
Peak ground acceleration:	0.94	Unit weight calculation:	Based on SBT	K_o applied:	Yes		

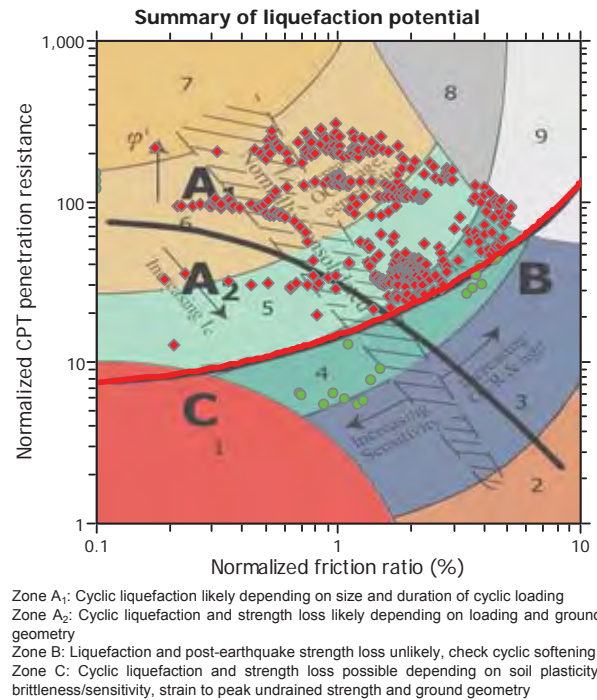
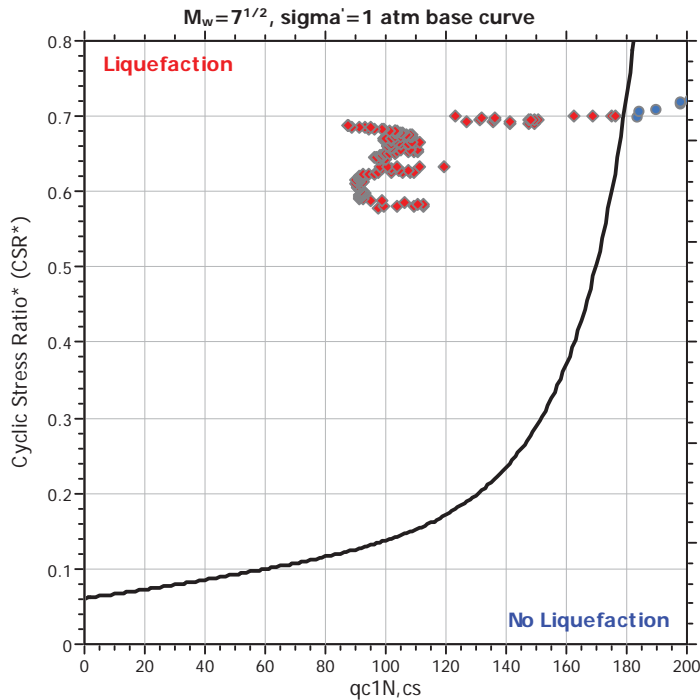
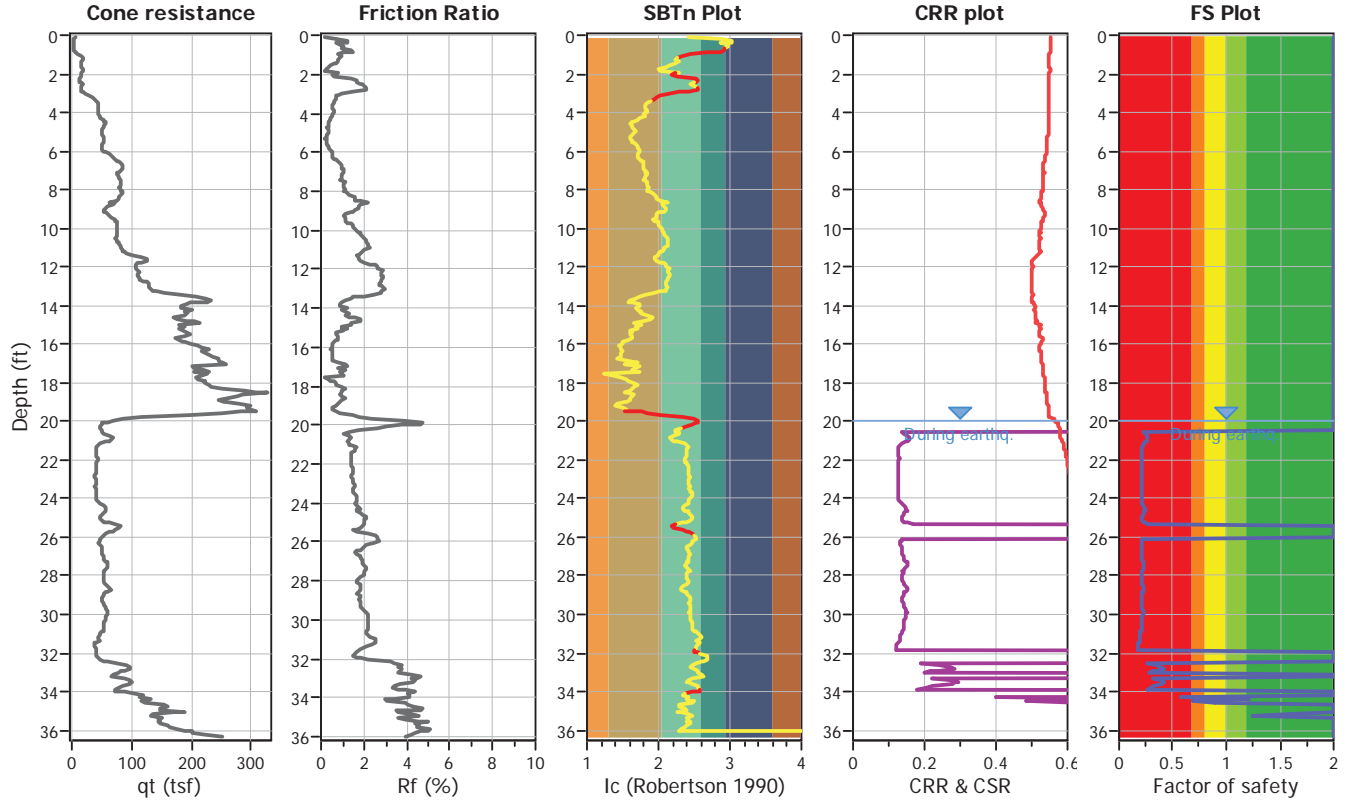

This software is licensed to: ENGEO Incorporated

CPT name: CPT-01

CPT basic interpretation plots (normalized)

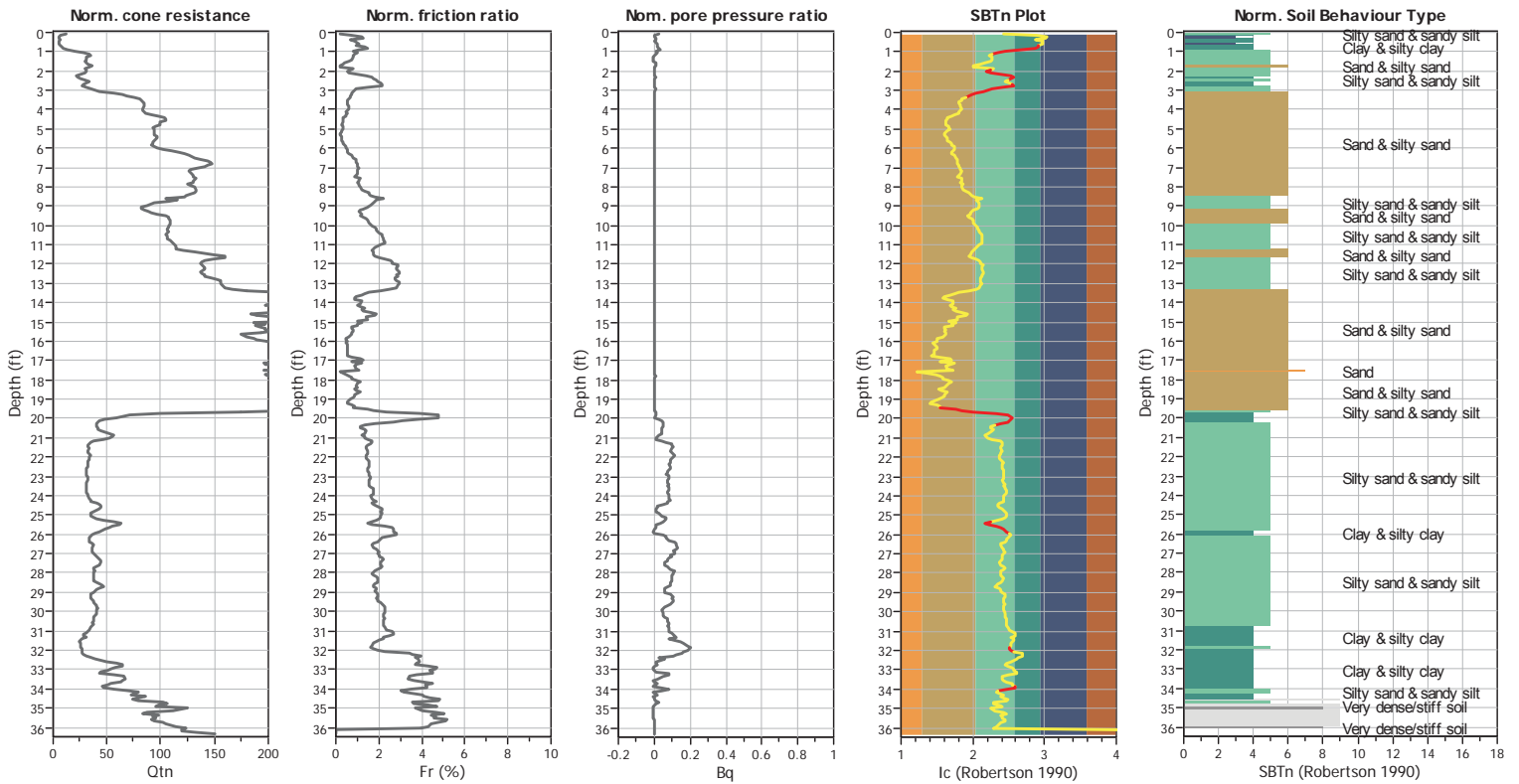

Input parameters and analysis data

Analysis method:	B&I (2014)	Depth to GWT (erthq.):	20.00 ft	Fill weight:	N/A
Fines correction method:	B&I (2014)	Average results interval:	1	Transition detect. applied:	Yes
Points to test:	Based on Ic value	Ic cut-off value:	2.60	K _o applied:	Yes
Earthquake magnitude M _w :	7.30	Unit weight calculation:	Based on SBT	Clay like behavior applied:	Sands only
Peak ground acceleration:	0.94	Use fill:	No	Limit depth applied:	No
Depth to water table (insitu):	20.00 ft	Fill height:	N/A	Limit depth:	N/A

SBTn legend

1. Sensitive fine grained	4. Clayey silt to silty	7. Gravely sand to sand
2. Organic material	5. Silty sand to sandy silt	8. Very stiff sand to
3. Clay to silty clay	6. Clean sand to silty sand	9. Very stiff fine grained

This software is licensed to: ENGEO Incorporated

CPT name: CPT-01

Liquefaction analysis overall plots

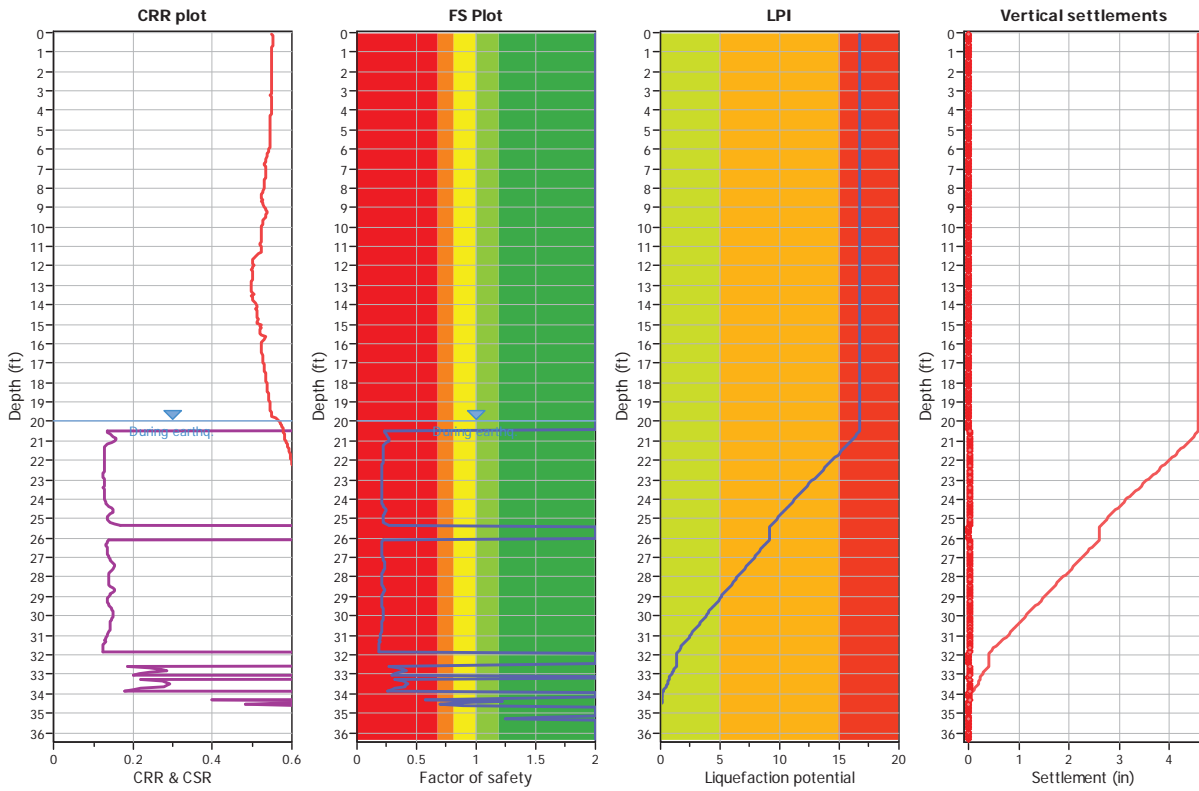

Input parameters and analysis data

Analysis method: B&I (2014)
 Fines correction method: B&I (2014)
 Points to test: Based on I_c value
 Earthquake magnitude M_w : 7.30
 Peak ground acceleration: 0.94
 Depth to water table (insitu): 20.00 ft

Depth to GWT (erthq.): 20.00 ft
 Average results interval: 1
 I_c cut-off value: 2.60
 Unit weight calculation: Based on SBT
 Use fill: No
 Fill height: N/A

Fill weight: N/A
 Transition detect. applied: Yes
 K_{σ} applied: Yes
 Clay like behavior applied: Sands only
 Limit depth applied: No
 Limit depth: N/A

F.S. color scheme

- Almost certain it will liquefy
- Very likely to liquefy
- Liquefaction and no liq. are equally likely
- Unlike to liquefy
- Almost certain it will not liquefy



LIQUEFACTION ANALYSIS REPORT

Project title : B Street Project

Location : Hayward, California

CPT file : CPT-02

Input parameters and analysis data

Analysis method:	B&I (2014)	G.W.T. (in-situ):	20.00 ft	Use fill:	No	Clay like behavior	
Fines correction method:	B&I (2014)	G.W.T. (earthq.):	20.00 ft	Fill height:	N/A	applied:	Sands only
Points to test:	Based on Ic value	Average results interval:	1	Fill weight:	N/A	Limit depth applied:	No
Earthquake magnitude M_w :	7.30	Ic cut-off value:	2.60	Trans. detect. applied:	Yes	Limit depth:	N/A
Peak ground acceleration:	0.94	Unit weight calculation:	Based on SBT	K_0 applied:	Yes	MSF method:	Method

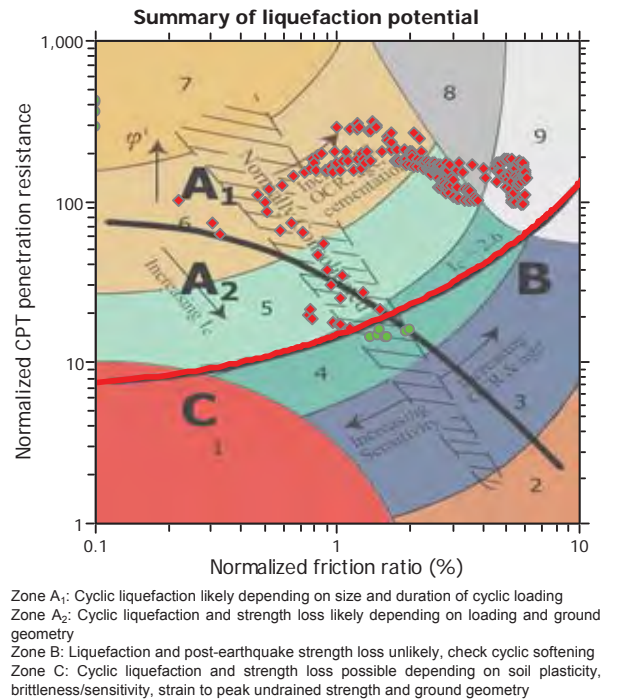
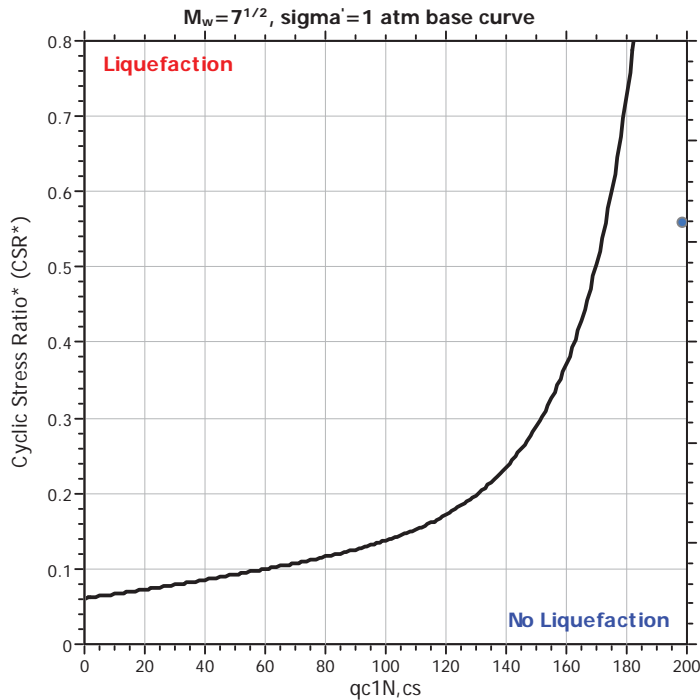
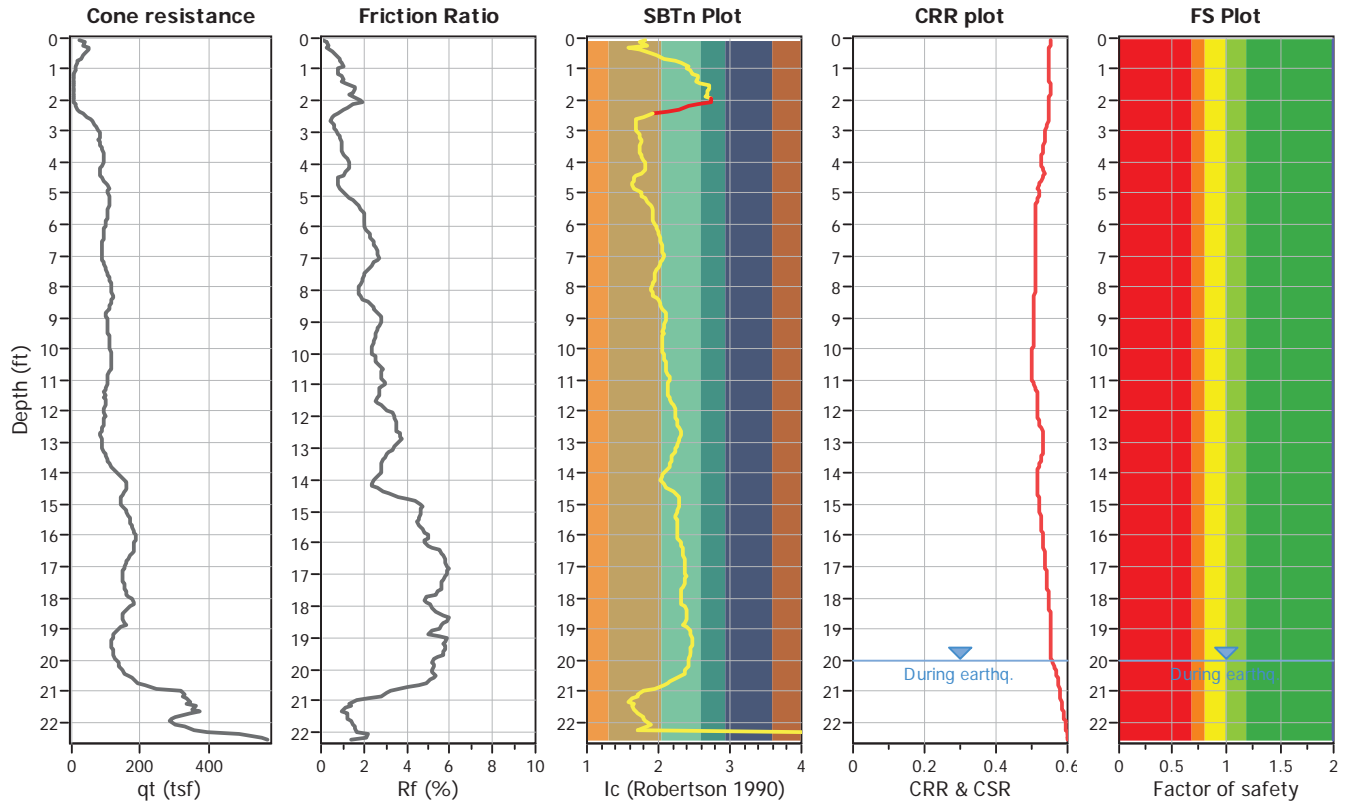

This software is licensed to: ENGEO Incorporated

CPT name: CPT-02

CPT basic interpretation plots (normalized)

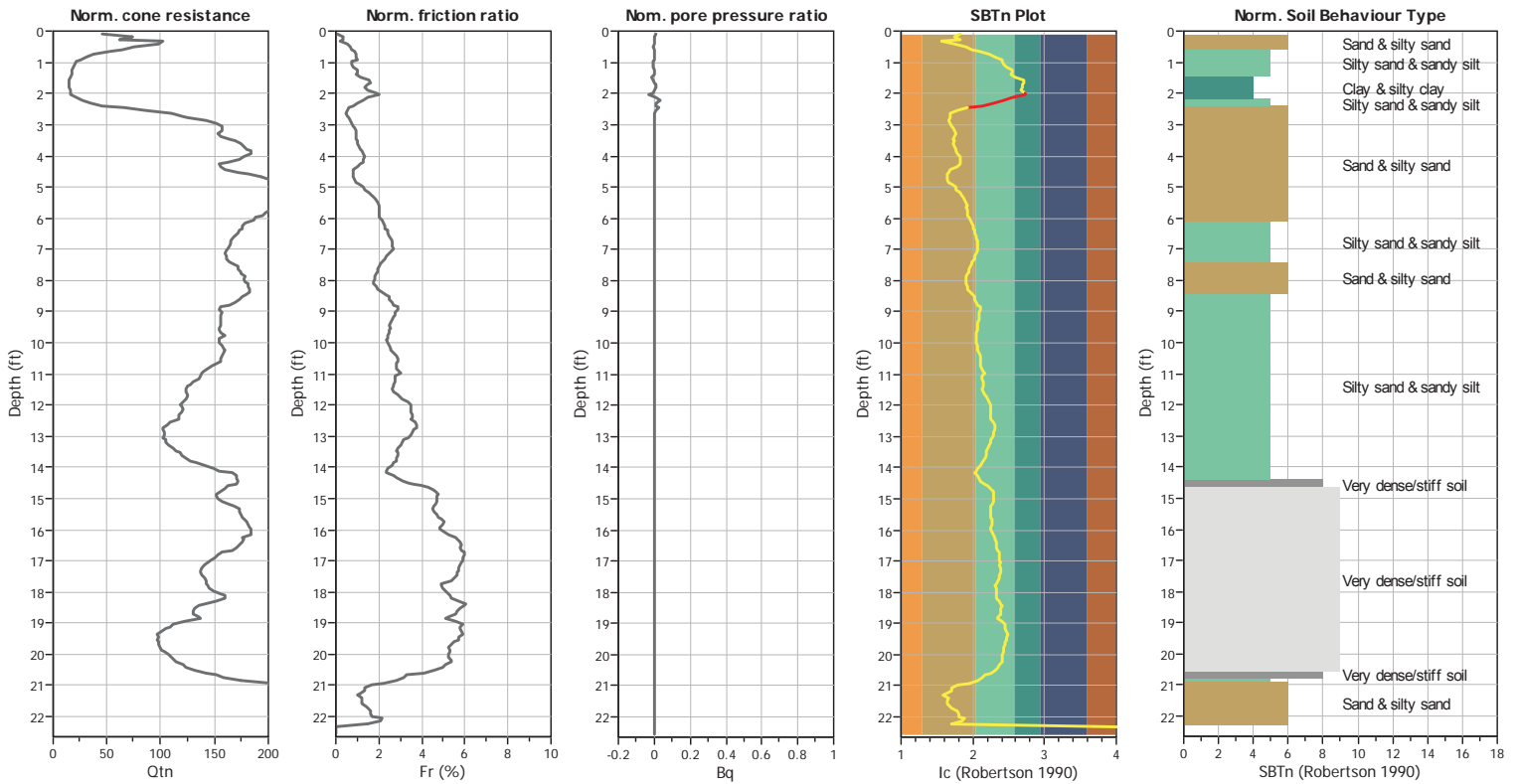

Input parameters and analysis data

Analysis method:	B&I (2014)	Depth to GWT (erthq.):	20.00 ft	Fill weight:	N/A
Fines correction method:	B&I (2014)	Average results interval:	1	Transition detect. applied:	Yes
Points to test:	Based on Ic value	Ic cut-off value:	2.60	K _o applied:	Yes
Earthquake magnitude M _w :	7.30	Unit weight calculation:	Based on SBT	Clay like behavior applied:	Sands only
Peak ground acceleration:	0.94	Use fill:	No	Limit depth applied:	No
Depth to water table (insitu):	20.00 ft	Fill height:	N/A	Limit depth:	N/A

SBTn legend

1. Sensitive fine grained	4. Clayey silt to silty	7. Gravely sand to sand
2. Organic material	5. Silty sand to sandy silt	8. Very stiff sand to
3. Clay to silty clay	6. Clean sand to silty sand	9. Very stiff fine grained

This software is licensed to: ENGEO Incorporated

CPT name: CPT-02

Liquefaction analysis overall plots

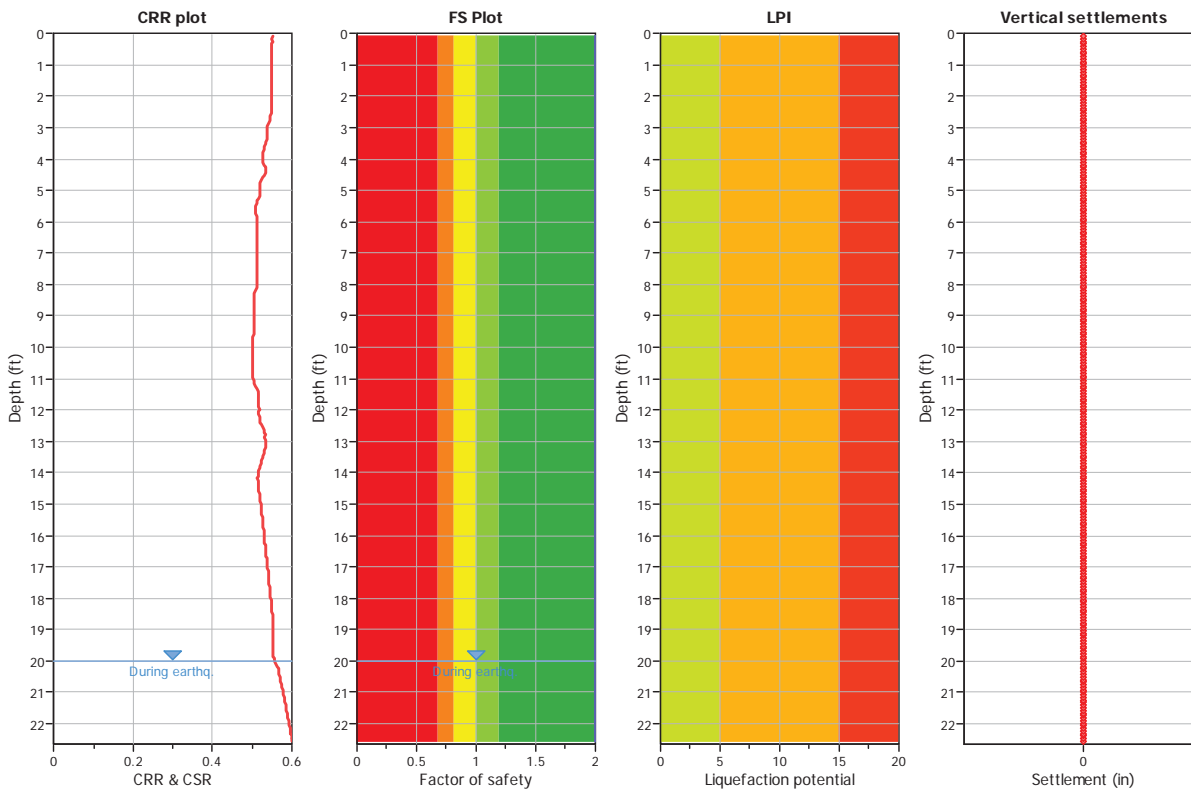

Input parameters and analysis data

Analysis method:	B&I (2014)	Depth to GWT (earthq.):	20.00 ft	Fill weight:	N/A
Fines correction method:	B&I (2014)	Average results interval:	1	Transition detect. applied:	Yes
Points to test:	Based on I _c value	I _c cut-off value:	2.60	K _σ applied:	Yes
Earthquake magnitude M _w :	7.30	Unit weight calculation:	Based on SBT	Clay like behavior applied:	Sands only
Peak ground acceleration:	0.94	Use fill:	No	Limit depth applied:	No
Depth to water table (insitu):	20.00 ft	Fill height:	N/A	Limit depth:	N/A

F.S. color scheme

- Almost certain it will liquefy
- Very likely to liquefy
- Liquefaction and no liq. are equally likely
- Unlike to liquefy
- Almost certain it will not liquefy



LIQUEFACTION ANALYSIS REPORT

Project title : B Street Project

Location : Hayward, California

CPT file : CPT-03

Input parameters and analysis data

Analysis method:	B&I (2014)	G.W.T. (in-situ):	20.00 ft	Use fill:	No	Clay like behavior	
Fines correction method:	B&I (2014)	G.W.T. (earthq.):	20.00 ft	Fill height:	N/A	applied:	Sands only
Points to test:	Based on Ic value	Average results interval:	1	Fill weight:	N/A	Limit depth applied:	No
Earthquake magnitude M_w :	7.30	Ic cut-off value:	2.60	Trans. detect. applied:	Yes	Limit depth:	N/A
Peak ground acceleration:	0.94	Unit weight calculation:	Based on SBT	K_o applied:	Yes	MSF method:	Method

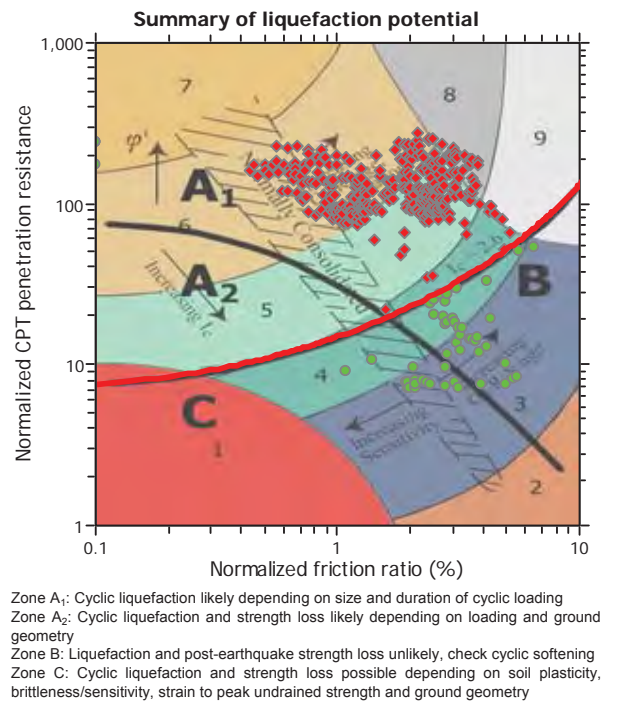
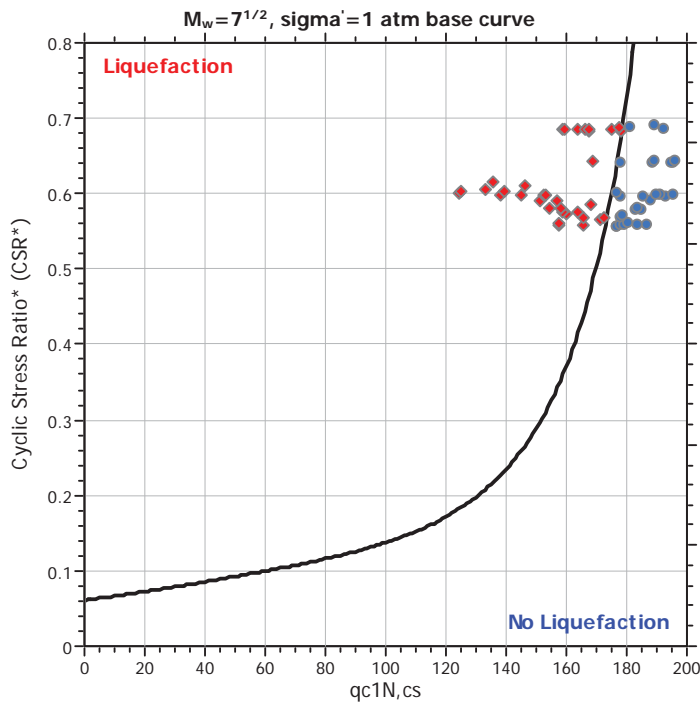
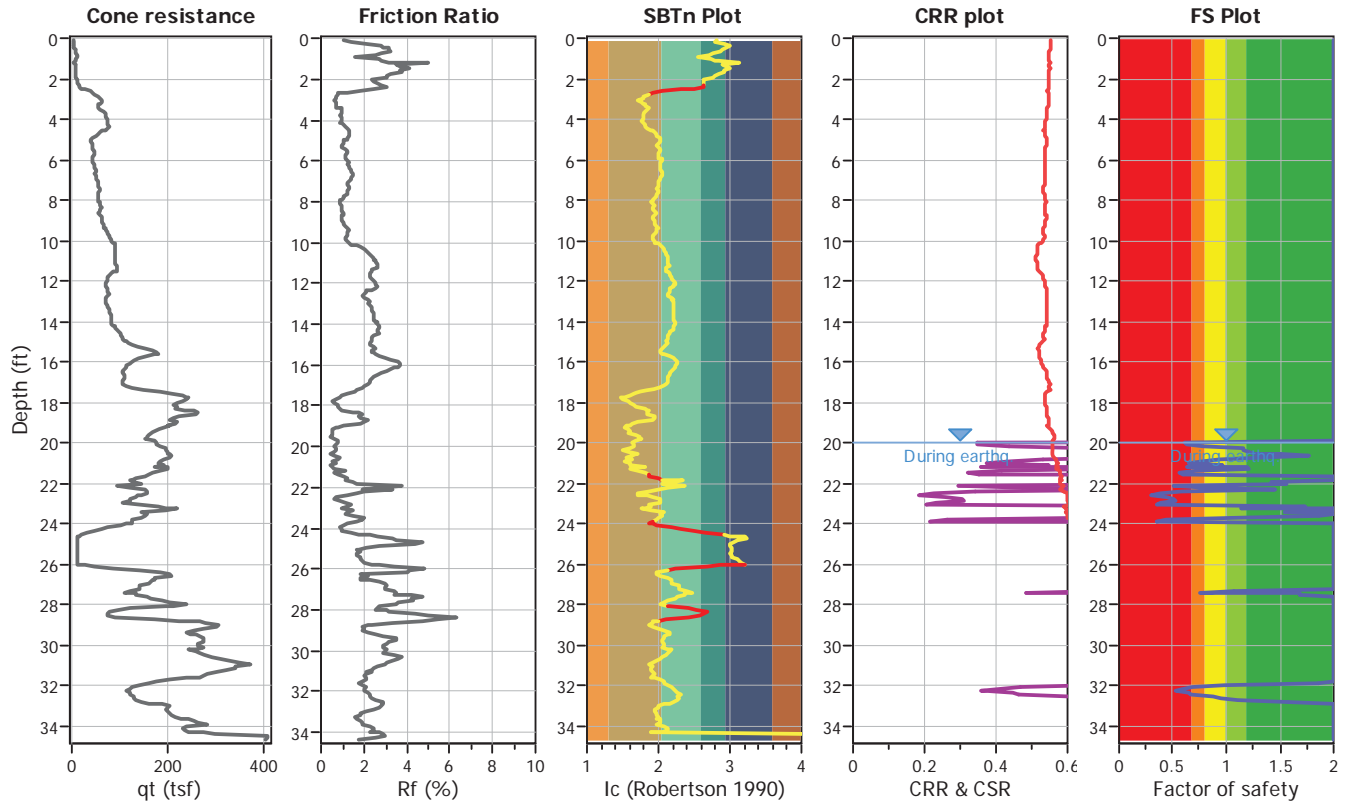

This software is licensed to: ENGEO Incorporated

CPT name: CPT-03

CPT basic interpretation plots (normalized)

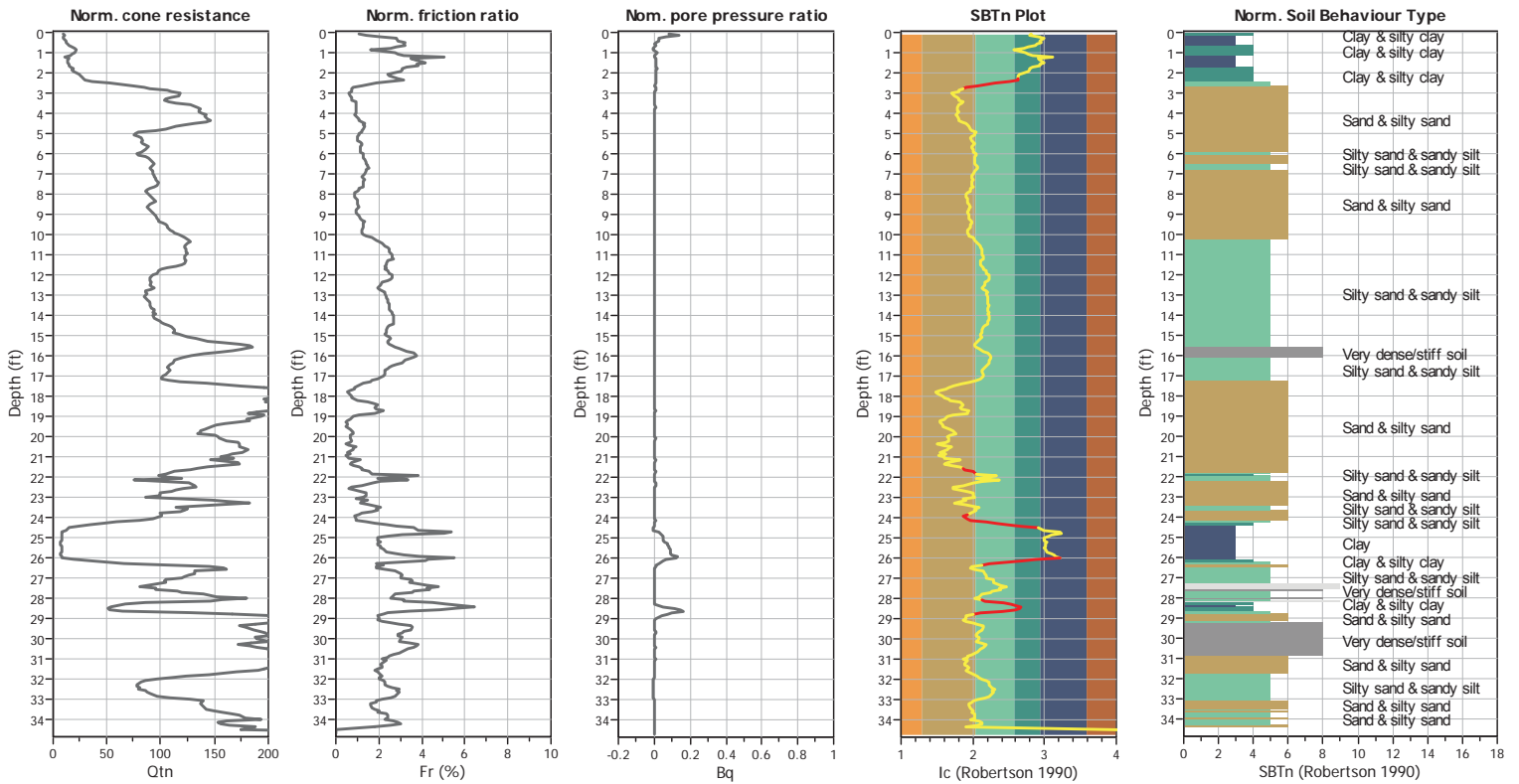

Input parameters and analysis data

Analysis method:	B&I (2014)	Depth to GWT (erthq.):	20.00 ft	Fill weight:	N/A
Fines correction method:	B&I (2014)	Average results interval:	1	Transition detect. applied:	Yes
Points to test:	Based on Ic value	Ic cut-off value:	2.60	K _o applied:	Yes
Earthquake magnitude M _w :	7.30	Unit weight calculation:	Based on SBT	Clay like behavior applied:	Sands only
Peak ground acceleration:	0.94	Use fill:	No	Limit depth applied:	No
Depth to water table (insitu):	20.00 ft	Fill height:	N/A	Limit depth:	N/A

SBTn legend

1. Sensitive fine grained	4. Clayey silt to silty	7. Gravely sand to sand
2. Organic material	5. Silty sand to sandy silt	8. Very stiff sand to
3. Clay to silty clay	6. Clean sand to silty sand	9. Very stiff fine grained

This software is licensed to: ENGEO Incorporated

CPT name: CPT-03

Liquefaction analysis overall plots

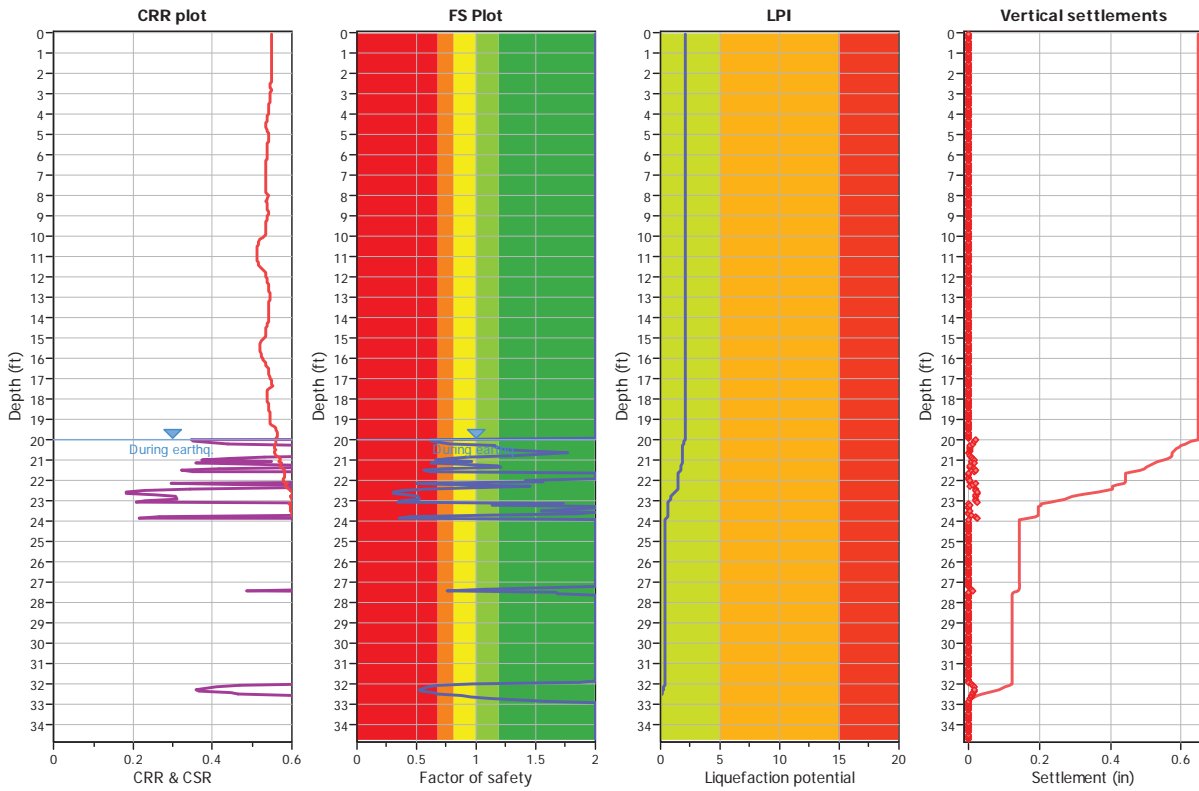

Input parameters and analysis data

Analysis method: B&I (2014)
 Fines correction method: B&I (2014)
 Points to test: Based on I_c value
 Earthquake magnitude M_w : 7.30
 Peak ground acceleration: 0.94
 Depth to water table (insitu): 20.00 ft

Depth to GWT (earthq.): 20.00 ft
 Average results interval: 1
 I_c cut-off value: 2.60
 Unit weight calculation: Based on SBT
 Use fill: No
 Fill height: N/A

Fill weight: N/A
 Transition detect. applied: Yes
 K_0 applied: Yes
 Clay like behavior applied: Sands only
 Limit depth applied: No
 Limit depth: N/A

F.S. color scheme

- Almost certain it will liquefy
- Very likely to liquefy
- Liquefaction and no liq. are equally likely
- Unlike to liquefy
- Almost certain it will not liquefy



LIQUEFACTION ANALYSIS REPORT

Project title : B Street Project

Location : Hayward, California

CPT file : CPT-04

Input parameters and analysis data

Analysis method:	B&I (2014)	G.W.T. (in-situ):	20.00 ft	Use fill:	No	Clay like behavior applied:	Sands only
Fines correction method:	B&I (2014)	G.W.T. (earthq.):	20.00 ft	Fill height:	N/A	Limit depth applied:	No
Points to test:	Based on Ic value	Average results interval:	1	Fill weight:	N/A	Limit depth:	N/A
Earthquake magnitude M_w :	7.30	Ic cut-off value:	2.60	Trans. detect. applied:	Yes	MSF method:	Method
Peak ground acceleration:	0.94	Unit weight calculation:	Based on SBT	K_o applied:	Yes		

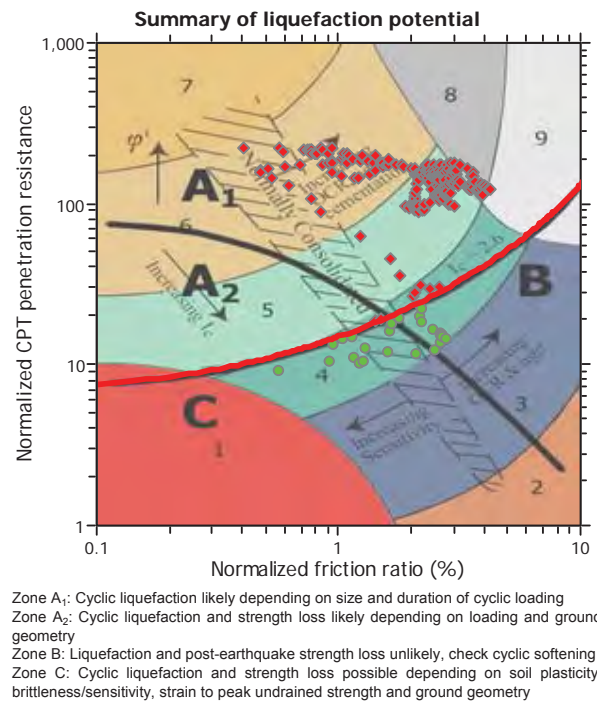
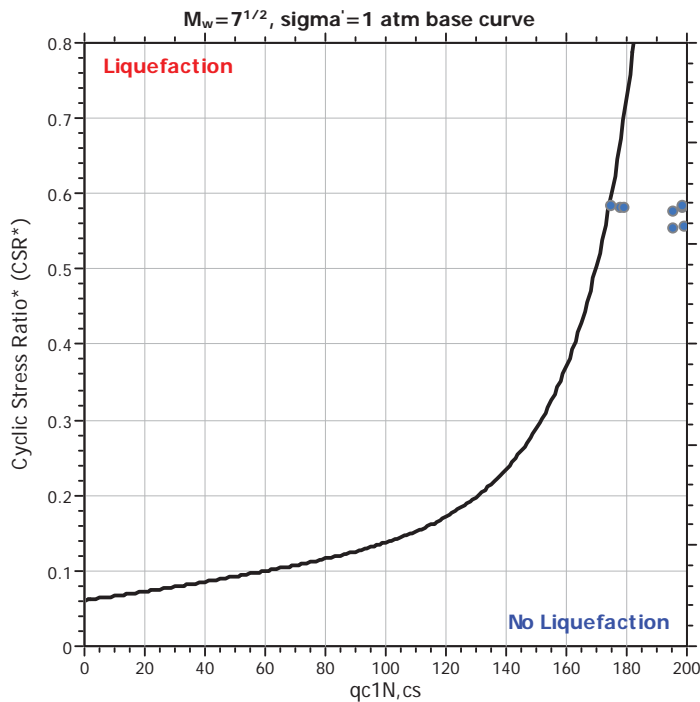
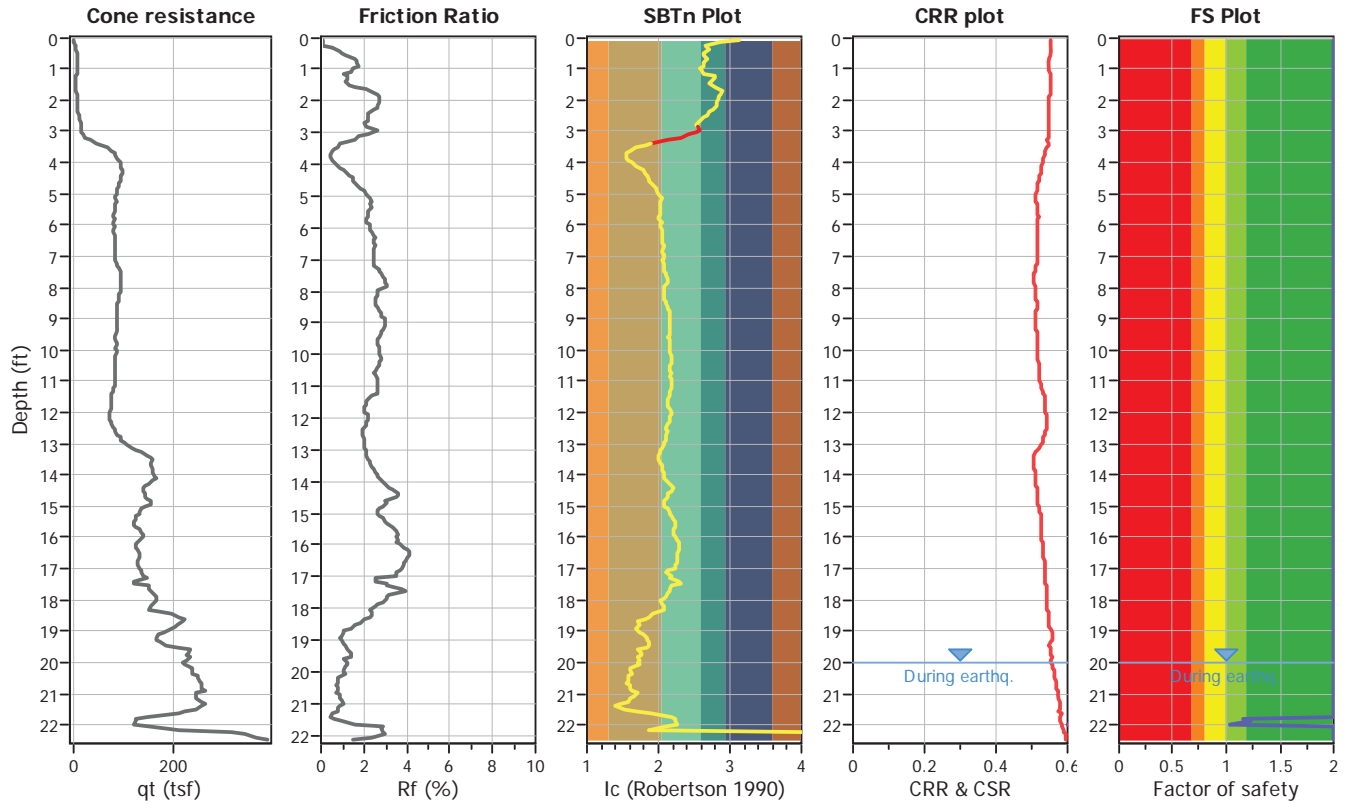

This software is licensed to: ENGEO Incorporated

CPT name: CPT-04

CPT basic interpretation plots (normalized)

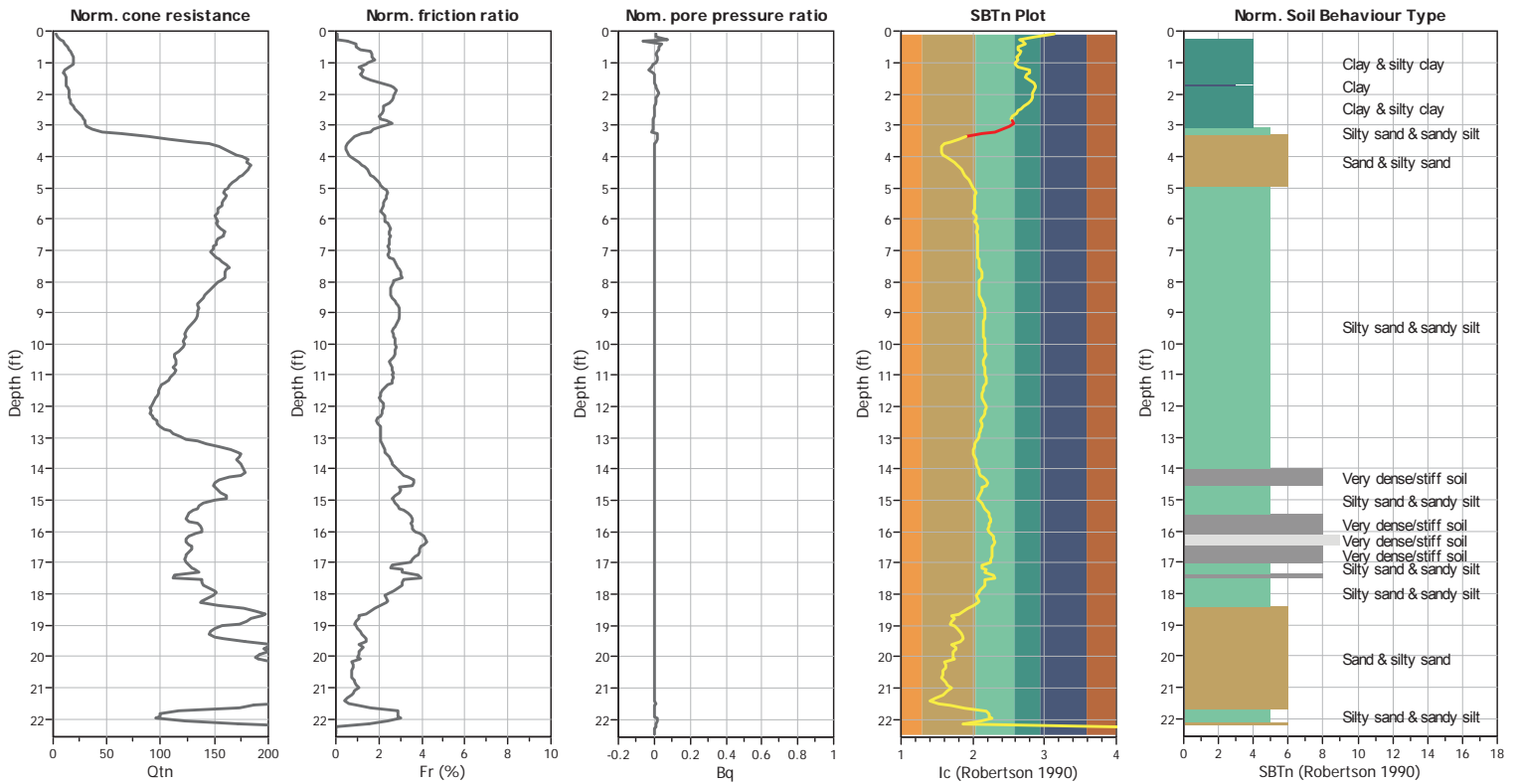

Input parameters and analysis data

Analysis method: B&I (2014)	Depth to GWT (erthq.): 20.00 ft	Fill weight: N/A
Fines correction method: B&I (2014)	Average results interval: 1	Transition detect. applied: Yes
Points to test: Based on Ic value	Ic cut-off value: 2.60	K _o applied: Yes
Earthquake magnitude M _w : 7.30	Unit weight calculation: Based on SBT	Clay like behavior applied: Sands only
Peak ground acceleration: 0.94	Use fill: No	Limit depth applied: No
Depth to water table (insitu): 20.00 ft	Fill height: N/A	Limit depth: N/A

SBTn legend

1. Sensitive fine grained	4. Clayey silt to silty	7. Gravely sand to sand
2. Organic material	5. Silty sand to sandy silt	8. Very stiff sand to
3. Clay to silty clay	6. Clean sand to silty sand	9. Very stiff fine grained

This software is licensed to: ENGEO Incorporated

CPT name: CPT-04

Liquefaction analysis overall plots

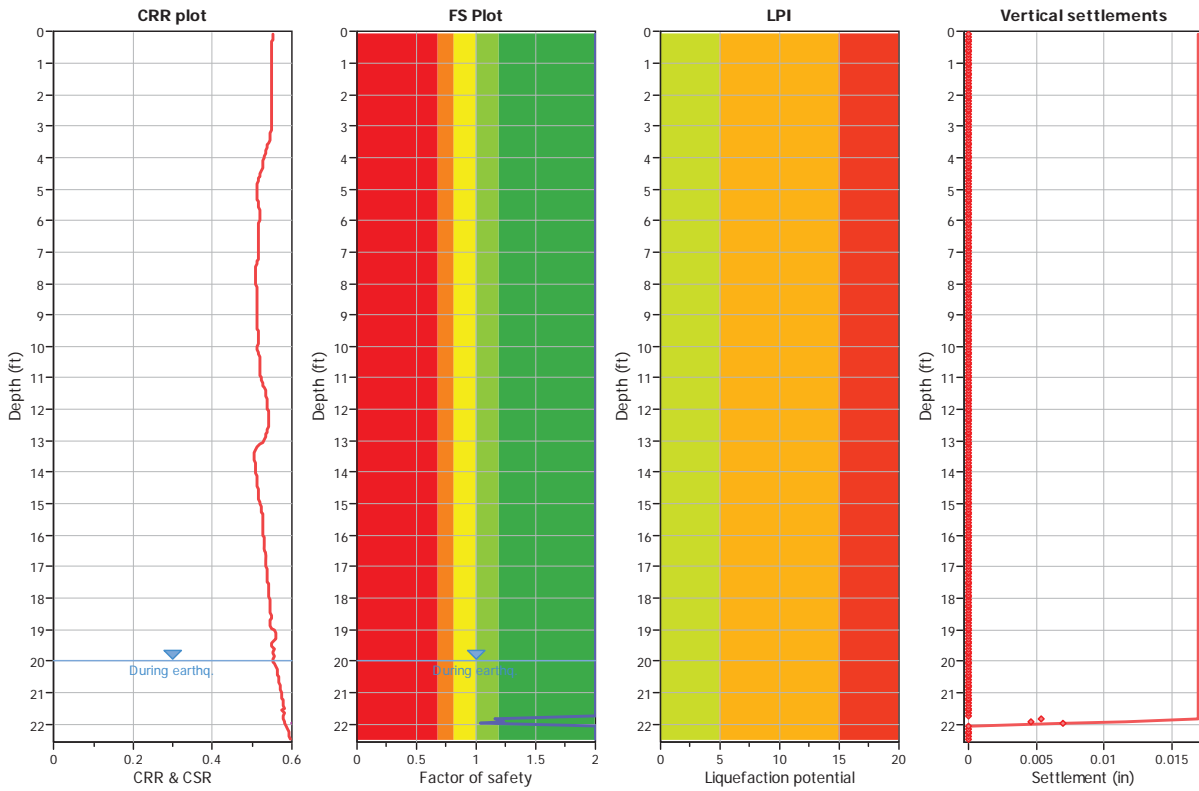

Input parameters and analysis data

Analysis method: B&I (2014)
 Fines correction method: B&I (2014)
 Points to test: Based on Ic value
 Earthquake magnitude M_w : 7.30
 Peak ground acceleration: 0.94
 Depth to water table (insitu): 20.00 ft

Depth to GWT (earthq.): 20.00 ft
 Average results interval: 1
 Ic cut-off value: 2.60
 Unit weight calculation: Based on SBT
 Use fill: No
 Fill height: N/A

Fill weight: N/A
 Transition detect. applied: Yes
 K_σ applied: Yes
 Clay like behavior applied: Sands only
 Limit depth applied: No
 Limit depth: N/A

F.S. color scheme

- Almost certain it will liquefy
- Very likely to liquefy
- Liquefaction and no liq. are equally likely
- Unlike to liquefy
- Almost certain it will not liquefy



LIQUEFACTION ANALYSIS REPORT

Project title : B Street Project

Location : Hayward, California

CPT file : CPT-05

Input parameters and analysis data

Analysis method:	B&I (2014)	G.W.T. (in-situ):	11.00 ft	Use fill:	No	Clay like behavior	
Fines correction method:	B&I (2014)	G.W.T. (earthq.):	11.00 ft	Fill height:	N/A	applied:	Sands only
Points to test:	Based on Ic value	Average results interval:	1	Fill weight:	N/A	Limit depth applied:	No
Earthquake magnitude M_w :	7.30	Ic cut-off value:	2.60	Trans. detect. applied:	Yes	Limit depth:	N/A
Peak ground acceleration:	0.94	Unit weight calculation:	Based on SBT	K_o applied:	Yes	MSF method:	Method

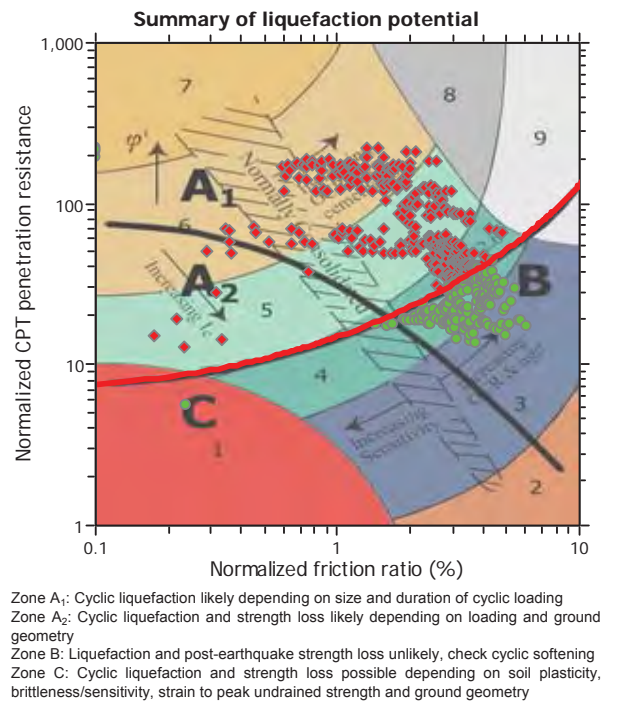
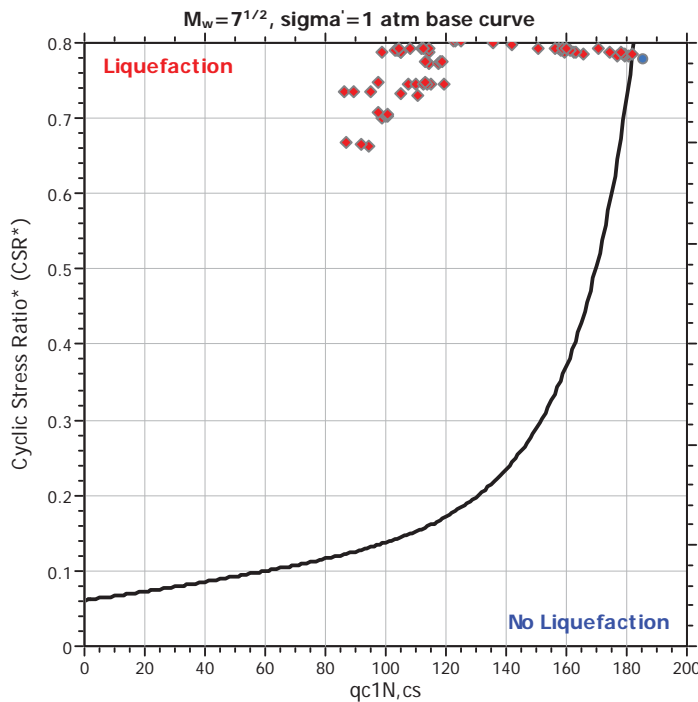
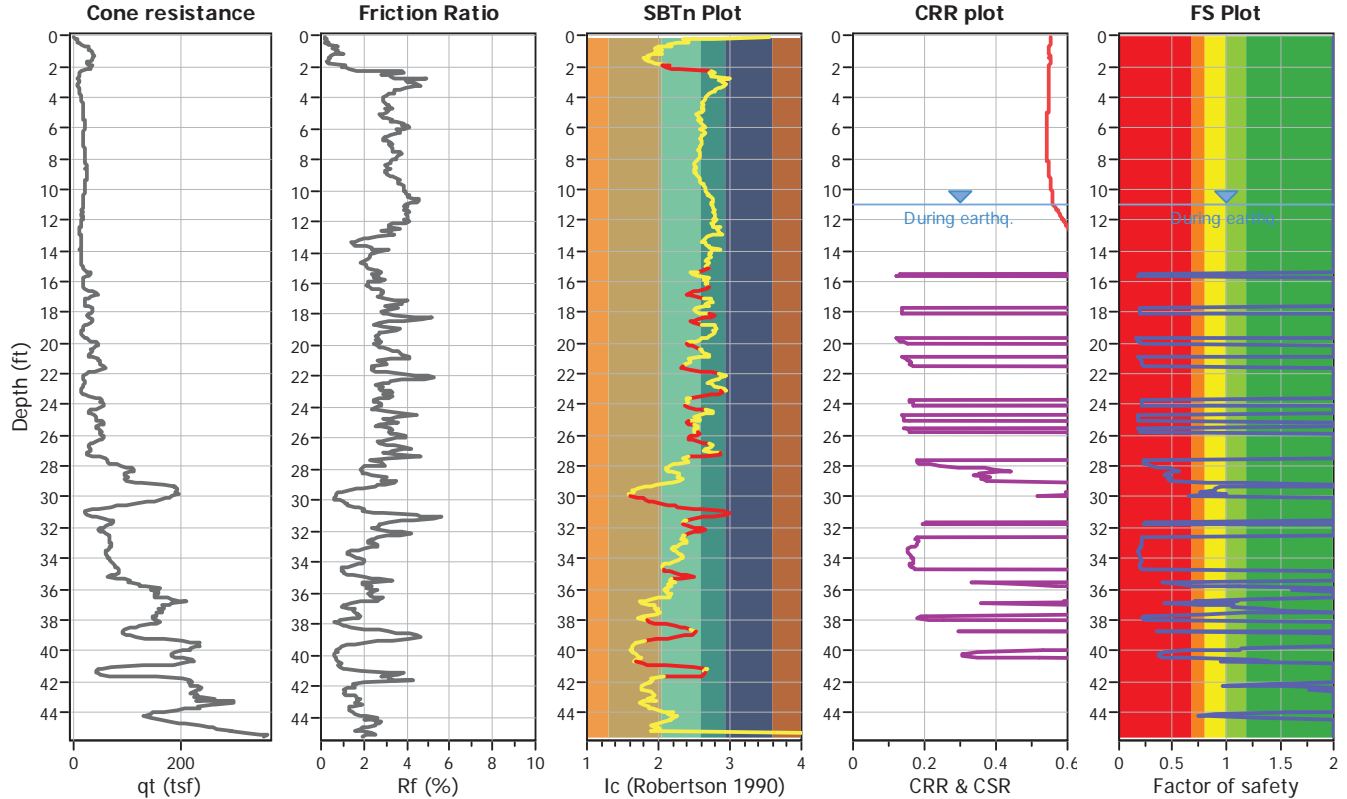

This software is licensed to: ENGEO Incorporated

CPT name: CPT-05

CPT basic interpretation plots (normalized)

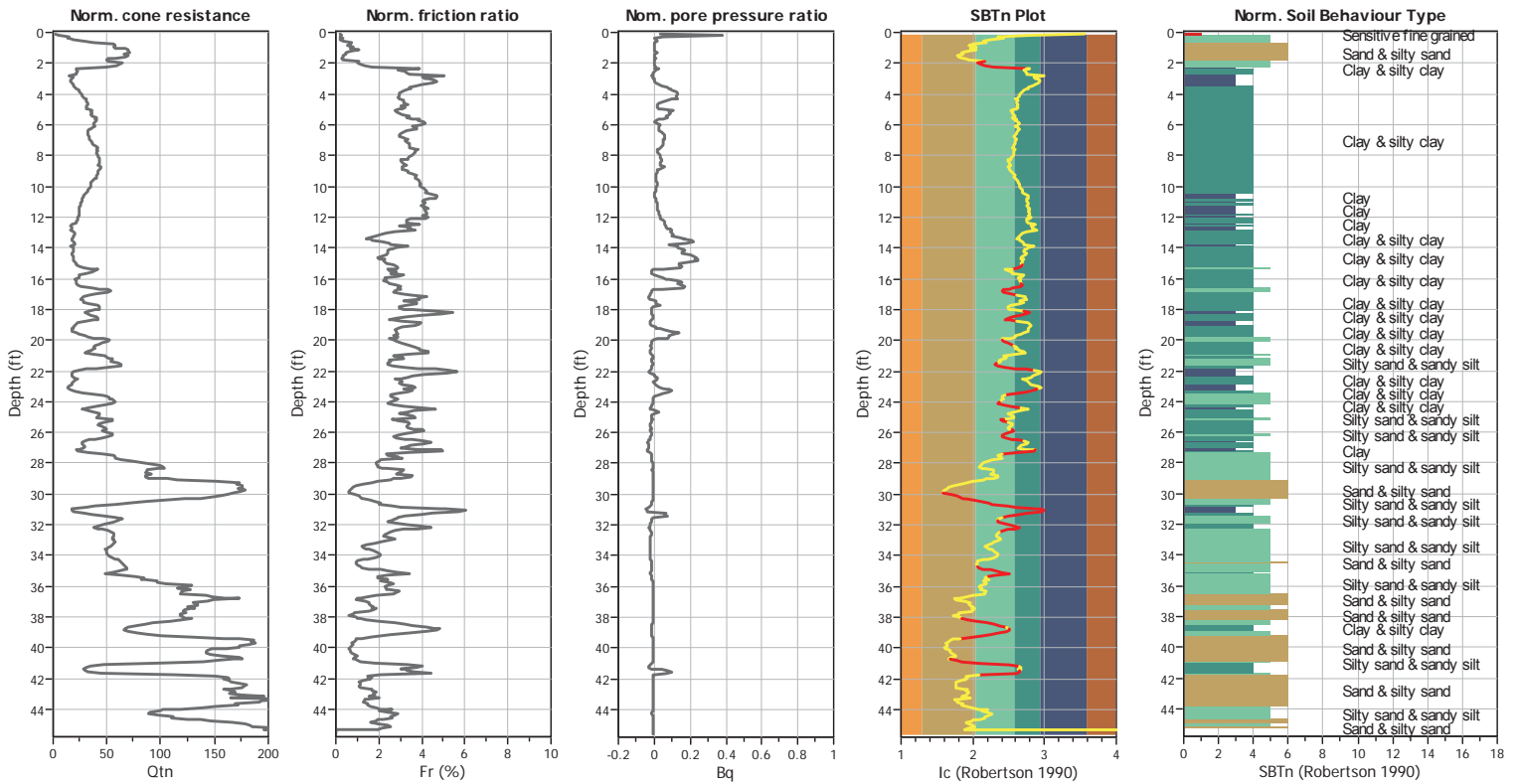

Input parameters and analysis data

Analysis method:	B&I (2014)	Depth to GWT (erthq.):	11.00 ft	Fill weight:	N/A
Fines correction method:	B&I (2014)	Average results interval:	1	Transition detect. applied:	Yes
Points to test:	Based on Ic value	Ic cut-off value:	2.60	K _o applied:	Yes
Earthquake magnitude M _w :	7.30	Unit weight calculation:	Based on SBT	Clay like behavior applied:	Sands only
Peak ground acceleration:	0.94	Use fill:	No	Limit depth applied:	No
Depth to water table (insitu):	11.00 ft	Fill height:	N/A	Limit depth:	N/A

SBTn legend

1. Sensitive fine grained	4. Clayey silt to silty	7. Gravely sand to sand
2. Organic material	5. Silty sand to sandy silt	8. Very stiff sand to
3. Clay to silty clay	6. Clean sand to silty sand	9. Very stiff fine grained

Liquefaction analysis overall plots

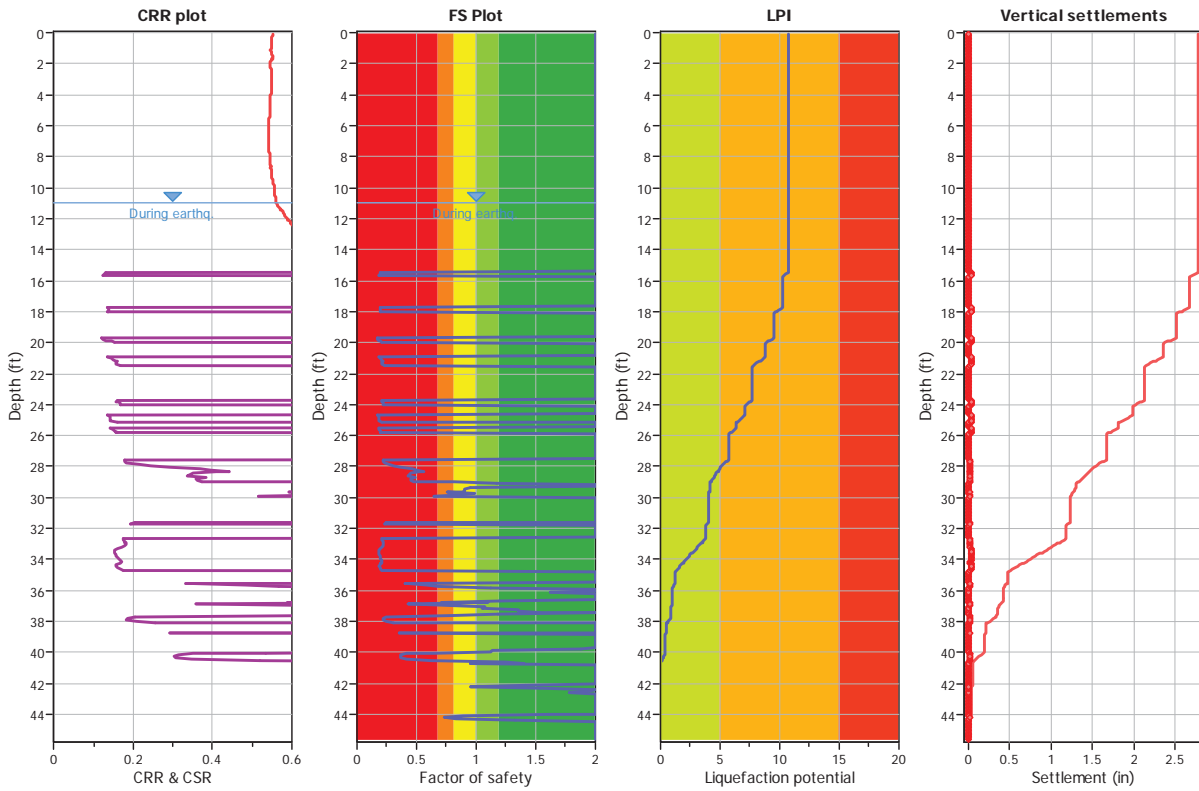

Input parameters and analysis data

Analysis method: B&I (2014)
 Fines correction method: B&I (2014)
 Points to test: Based on I_c value
 Earthquake magnitude M_w : 7.30
 Peak ground acceleration: 0.94
 Depth to water table (insitu): 11.00 ft

Depth to GWT (earthq.): 11.00 ft
 Average results interval: 1
 I_c cut-off value: 2.60
 Unit weight calculation: Based on SBT
 Use fill: No
 Fill height: N/A

Fill weight: N/A
 Transition detect. applied: Yes
 K_0 applied: Yes
 Clay like behavior applied: Sands only
 Limit depth applied: No
 Limit depth: N/A

F.S. color scheme

- Red: Almost certain it will liquefy
- Orange: Very likely to liquefy
- Yellow: Liquefaction and no liq. are equally likely
- Green: Unlike to liquefy
- Dark Green: Almost certain it will not liquefy



APPENDIX D

SLOPE STABILITY ANALYSIS

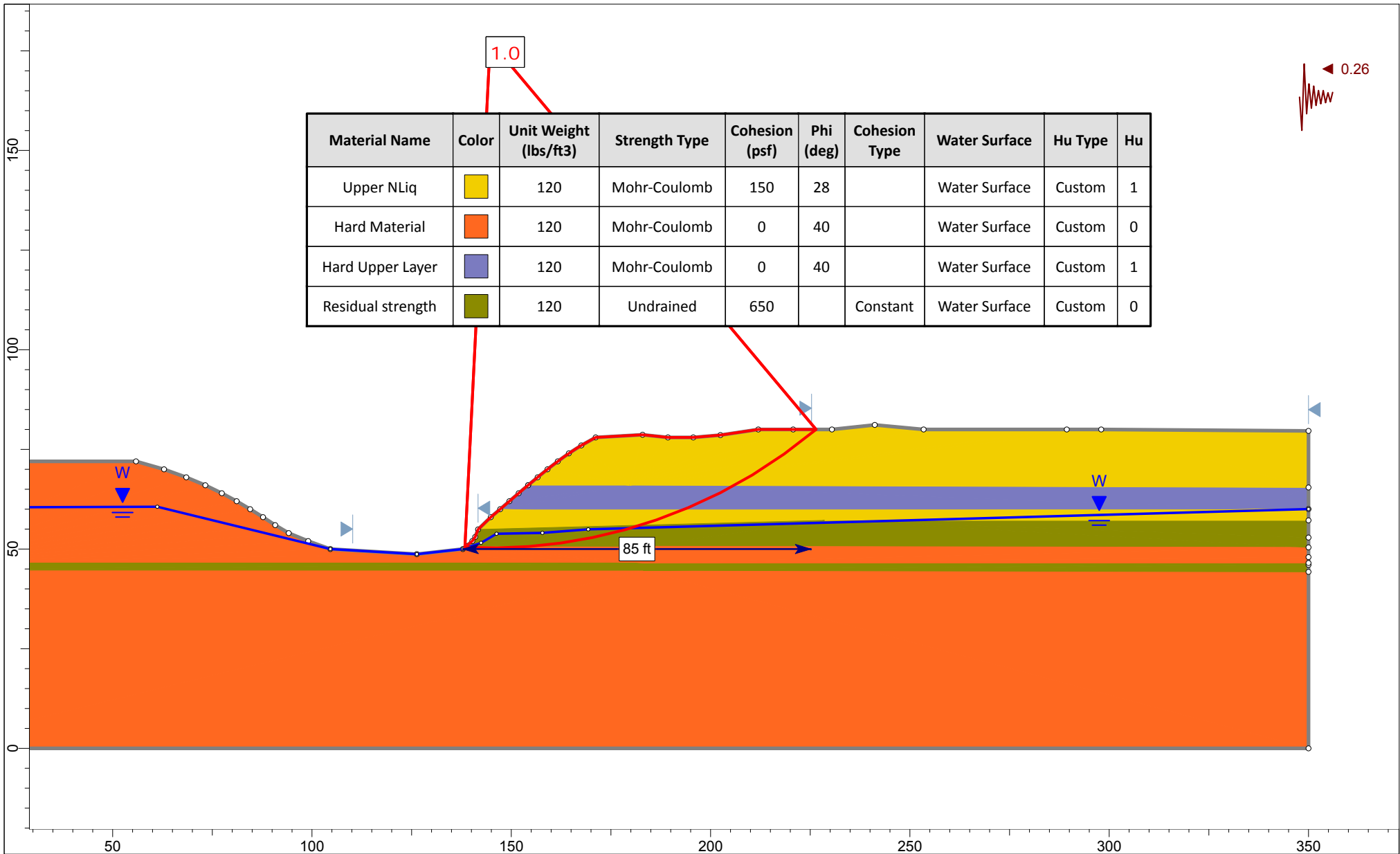

Material Name	Color	Unit Weight (lbs/ft ³)	Strength Type	Cohesion (psf)	Phi (deg)	Cohesion Type	Water Surface	Hu Type	Hu
Upper NLIq	Yellow	120	Mohr-Coulomb	150	28		Water Surface	Custom	1
Hard Material	Orange	120	Mohr-Coulomb	0	40		Water Surface	Custom	0
Hard Upper Layer	Blue	120	Mohr-Coulomb	0	40		Water Surface	Custom	1
Residual strength	Green	120	Undrained	650		Constant	Water Surface	Custom	0



SLIDEINTERPRET 7.020

Project		B Street Project	
Analysis Description		Seismic	
Drawn By	MCP	Scale	1:400
Date	1/3/2017, 4:32:18 PM	Company	ENGEO
		File Name	13599 Pseudo Static.slim

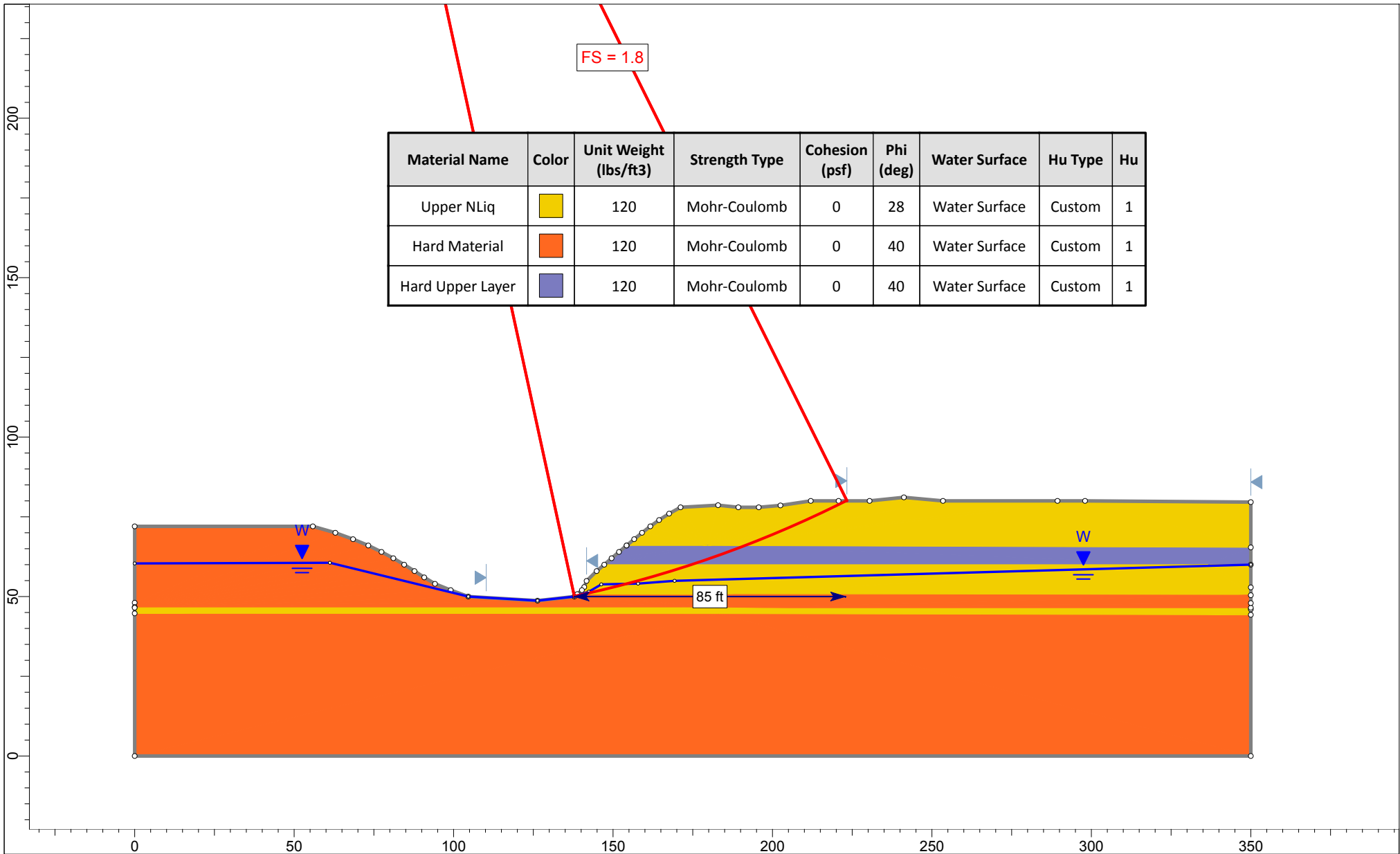

	Project			B Street Project		
	Analysis Description			Static		
	Drawn By	MCP	Scale	1:500	Company	ENGEO
	Date	1/3/2017, 4:32:18 PM		File Name	13599 Static.slim	



SAN RAMON
SAN FRANCISCO
SAN JOSE
OAKLAND
LATHROP
ROCKLIN
SANTA CLARITA
IRVINE
CHRISTCHURCH
WELLINGTON
AUCKLAND

Appendix C

Noise Measurement Data

Freq Weight : A
 Time Weight : FAST
 Level Range : 40-100
 Max dB : 71.7 - 2018/02/15 16: 54: 39
 Level Range : 40-100
 SEL : 82.2
 Leq : 52.7

No. s	Date Time	(dB)					
1	2018/02/15 16: 54: 22	65.1	61.2	58.8	61.4	61.1	
6	2018/02/15 16: 54: 27	63.1	66.5	63.0	65.9	65.5	
11	2018/02/15 16: 54: 32	62.7	64.7	65.3	63.4	69.3	
16	2018/02/15 16: 54: 37	66.9	69.9	62.7	60.7	65.0	
21	2018/02/15 16: 54: 42	62.7	59.6	59.7	59.6	59.7	
26	2018/02/15 16: 54: 47	60.7	60.2	61.7	58.4	53.2	
31	2018/02/15 16: 54: 52	57.5	54.4	55.1	52.2	49.5	
36	2018/02/15 16: 54: 57	51.2	50.4	50.0	49.1	49.3	
41	2018/02/15 16: 55: 02	49.4	63.1	49.6	49.0	49.2	
46	2018/02/15 16: 55: 07	48.1	47.8	46.2	46.4	47.3	
51	2018/02/15 16: 55: 12	47.2	46.6	47.4	46.8	46.4	
56	2018/02/15 16: 55: 17	45.4	45.8	45.9	45.0	44.4	
61	2018/02/15 16: 55: 22	43.5	43.5	43.5	42.9	42.6	
66	2018/02/15 16: 55: 27	43.3	44.1	43.5	45.1	46.4	
71	2018/02/15 16: 55: 32	45.7	45.9	46.8	46.6	47.1	
76	2018/02/15 16: 55: 37	49.5	48.4	51.1	50.5	51.1	
81	2018/02/15 16: 55: 42	51.4	50.6	51.1	49.9	51.3	
86	2018/02/15 16: 55: 47	50.1	51.3	51.0	50.1	50.0	
91	2018/02/15 16: 55: 52	50.3	51.7	50.9	61.4	49.9	
96	2018/02/15 16: 55: 57	51.0	51.0	50.2	51.2	51.2	
101	2018/02/15 16: 56: 02	50.7	50.1	51.4	51.3	50.6	
106	2018/02/15 16: 56: 07	50.6	50.1	50.7	50.4	49.8	
111	2018/02/15 16: 56: 12	48.9	48.6	49.0	49.0	49.7	
116	2018/02/15 16: 56: 17	49.9	49.5	50.1	51.0	50.1	
121	2018/02/15 16: 56: 22	50.7	50.3	48.9	48.3	48.3	
126	2018/02/15 16: 56: 27	48.0	48.3	48.7	49.0	51.4	
131	2018/02/15 16: 56: 32	52.3	50.1	49.9	49.9	49.7	
136	2018/02/15 16: 56: 37	50.1	50.6	50.1	51.4	53.3	
141	2018/02/15 16: 56: 42	52.1	51.7	51.4	50.9	50.9	
146	2018/02/15 16: 56: 47	52.3	51.2	50.8	51.2	50.7	
151	2018/02/15 16: 56: 52	50.6	50.9	51.7	50.8	50.2	
156	2018/02/15 16: 56: 57	52.0	50.7	50.2	51.7	49.6	
161	2018/02/15 16: 57: 02	49.9	50.6	50.1	50.0	49.7	
166	2018/02/15 16: 57: 07	49.3	50.8	48.5	50.0	49.4	
171	2018/02/15 16: 57: 12	49.0	50.1	49.5	48.8	48.0	
176	2018/02/15 16: 57: 17	48.7	48.6	48.9	49.0	49.4	
181	2018/02/15 16: 57: 22	52.5	50.2	51.3	50.1	48.5	
186	2018/02/15 16: 57: 27	48.2	48.4	48.7	48.5	49.1	
191	2018/02/15 16: 57: 32	49.8	48.7	49.5	50.0	49.2	
196	2018/02/15 16: 57: 37	48.9	49.3	49.2	49.5	50.3	
201	2018/02/15 16: 57: 42	48.5	49.4	48.7	47.5	48.7	
206	2018/02/15 16: 57: 47	48.0	47.8	48.2	48.8	50.1	
211	2018/02/15 16: 57: 52	49.7	51.5	52.6	49.2	49.4	
216	2018/02/15 16: 57: 57	47.6	47.4	46.5	47.8	47.3	
221	2018/02/15 16: 58: 02	48.0	47.4	47.1	48.0	49.7	
226	2018/02/15 16: 58: 07	47.0	47.1	46.8	47.4	48.8	
231	2018/02/15 16: 58: 12	48.8	47.5	47.9	50.6	47.3	
236	2018/02/15 16: 58: 17	47.5	46.8	46.0	47.2	47.1	
241	2018/02/15 16: 58: 22	47.7	49.5	49.8	50.8	50.6	
246	2018/02/15 16: 58: 27	50.1	50.3	50.8	54.0	53.6	
251	2018/02/15 16: 58: 32	52.6	51.9	50.5	62.3	60.5	
256	2018/02/15 16: 58: 37	51.2	50.2	49.6	50.1	49.5	
261	2018/02/15 16: 58: 42	48.7	49.9	48.8	48.7	49.1	
266	2018/02/15 16: 58: 47	48.0	48.0	48.3	47.9	48.3	
271	2018/02/15 16: 58: 52	48.2	48.3	48.8	48.3	48.6	
276	2018/02/15 16: 58: 57	49.6	50.3	51.4	50.9	51.0	
281	2018/02/15 16: 59: 02	51.1	52.3	52.1	50.9	51.6	
286	2018/02/15 16: 59: 07	51.6	51.6	51.3	50.1	51.2	
291	2018/02/15 16: 59: 12	50.7	50.1	49.9	50.8	50.1	
296	2018/02/15 16: 59: 17	50.2	51.1	52.9	51.7	51.7	
301	2018/02/15 16: 59: 22	52.7	53.6	52.4	53.1	52.1	
306	2018/02/15 16: 59: 27	51.2	50.5	50.7	50.1	50.5	
311	2018/02/15 16: 59: 32	49.9	49.2	48.9	47.6	47.9	
316	2018/02/15 16: 59: 37	48.1	49.3	49.8	48.2	51.2	
321	2018/02/15 16: 59: 42	50.7	50.5	55.0	49.5	48.0	
326	2018/02/15 16: 59: 47	48.3	49.5	47.6	48.1	51.0	
331	2018/02/15 16: 59: 52	48.6	48.5	46.6	46.8	47.8	
336	2018/02/15 16: 59: 57	47.1	48.8	46.5	49.0	47.8	
341	2018/02/15 17: 00: 02	47.3	46.9	46.7	46.2	45.7	
346	2018/02/15 17: 00: 07	47.7	46.6	47.0	46.7	47.5	
351	2018/02/15 17: 00: 12	50.4	50.6	53.7	51.3	50.8	
356	2018/02/15 17: 00: 17	50.1	50.4	51.9	55.8	59.7	
361	2018/02/15 17: 00: 22	60.2	57.6	54.2	52.8	53.2	
366	2018/02/15 17: 00: 27	51.5	50.9	50.8	51.0	50.2	
371	2018/02/15 17: 00: 32	49.2	49.9	50.8	50.8	51.0	
376	2018/02/15 17: 00: 37	50.6	50.8	50.3	50.0	50.2	
381	2018/02/15 17: 00: 42	50.9	50.8	50.2	50.0	50.5	
386	2018/02/15 17: 00: 47	49.8	49.9	50.2	49.7	51.5	
391	2018/02/15 17: 00: 52	49.8	50.0	49.9	50.4	49.8	
396	2018/02/15 17: 00: 57	50.6	49.7	48.7	49.0	49.3	
401	2018/02/15 17: 01: 02	47.8	47.5	48.3	49.2	49.0	
406	2018/02/15 17: 01: 07	47.8	47.9	47.4	48.0	47.9	
411	2018/02/15 17: 01: 12	47.4	48.8	48.8	49.3	49.6	
416	2018/02/15 17: 01: 17	49.9	49.3	49.6	49.2	50.2	
421	2018/02/15 17: 01: 22	50.6	49.3	51.7	49.2	50.5	

426	2018/02/15	17:01:27	50.0	49.3	49.6	50.4	50.4
431	2018/02/15	17:01:32	50.6	51.7	51.0	51.3	51.7
436	2018/02/15	17:01:37	50.3	50.2	49.5	49.2	48.7
441	2018/02/15	17:01:42	48.7	48.9	48.4	48.5	46.3
446	2018/02/15	17:01:47	45.9	46.5	45.9	45.6	46.7
451	2018/02/15	17:01:52	45.9	46.3	46.8	47.9	47.5
456	2018/02/15	17:01:57	47.3	48.9	48.2	47.8	49.3
461	2018/02/15	17:02:02	47.8	48.2	48.8	47.5	48.3
466	2018/02/15	17:02:07	49.0	48.4	48.6	48.1	48.0
471	2018/02/15	17:02:12	47.2	47.9	47.7	48.0	47.2
476	2018/02/15	17:02:17	47.4	48.5	47.2	47.8	48.4
481	2018/02/15	17:02:22	48.0	48.9	48.8	49.1	63.7
486	2018/02/15	17:02:27	63.0	49.4	49.5	50.2	49.3
491	2018/02/15	17:02:32	49.0	50.1	49.8	49.3	49.0
496	2018/02/15	17:02:37	48.8	49.3	49.7	50.2	49.6
501	2018/02/15	17:02:42	49.8	50.7	50.2	49.6	50.0
506	2018/02/15	17:02:47	49.2	52.9	50.4	49.6	50.3
511	2018/02/15	17:02:52	49.3	49.2	47.6	47.6	46.2
516	2018/02/15	17:02:57	45.5	46.9	44.6	45.1	45.4
521	2018/02/15	17:03:02	43.9	44.8	45.2	45.5	45.0
526	2018/02/15	17:03:07	45.8	45.4	44.9	45.8	45.8
531	2018/02/15	17:03:12	46.0	47.8	46.0	46.4	46.5
536	2018/02/15	17:03:17	47.5	47.2	47.2	48.4	49.1
541	2018/02/15	17:03:22	50.5	49.4	49.3	49.0	49.8
546	2018/02/15	17:03:27	49.8	48.7	48.0	48.2	48.0
551	2018/02/15	17:03:32	48.5	49.6	48.9	48.3	48.7
556	2018/02/15	17:03:37	50.0	48.6	49.0	49.5	49.1
561	2018/02/15	17:03:42	49.0	49.1	51.4	53.2	52.3
566	2018/02/15	17:03:47	51.8	50.9	49.8	50.5	50.8
571	2018/02/15	17:03:52	51.9	52.5	54.6	52.3	51.1
576	2018/02/15	17:03:57	52.6	51.3	52.5	50.8	50.1
581	2018/02/15	17:04:02	50.8	50.7	50.5	49.7	48.9
586	2018/02/15	17:04:07	49.4	49.1	48.6	49.8	51.5
591	2018/02/15	17:04:12	52.2	51.5	51.4	53.1	52.1
596	2018/02/15	17:04:17	52.0	52.4	50.0	50.3	50.3
601	2018/02/15	17:04:22	51.5	51.3	49.9	49.9	49.0
606	2018/02/15	17:04:27	48.6	48.9	49.0	49.5	49.4
611	2018/02/15	17:04:32	49.5	49.0	49.6	49.1	49.7
616	2018/02/15	17:04:37	49.0	49.7	48.3	49.8	50.4
621	2018/02/15	17:04:42	50.6	48.4	47.8	47.4	48.1
626	2018/02/15	17:04:47	48.6	47.8	47.1	46.6	47.4
631	2018/02/15	17:04:52	47.0	48.2	48.1	48.6	49.9
636	2018/02/15	17:04:57	48.9	48.8	48.8	49.1	51.4
641	2018/02/15	17:05:02	51.3	50.9	50.7	50.4	51.6
646	2018/02/15	17:05:07	50.2	50.0	49.8	49.7	50.1
651	2018/02/15	17:05:12	50.3	51.1	50.6	50.8	50.9
656	2018/02/15	17:05:17	51.9	50.3	50.4	52.5	51.1
661	2018/02/15	17:05:22	51.9	51.0	50.9	50.1	50.5
666	2018/02/15	17:05:27	51.1	50.5	48.5	49.4	48.5
671	2018/02/15	17:05:32	48.3	47.7	47.3	47.9	47.4
676	2018/02/15	17:05:37	48.4	48.4	48.7	48.7	47.8
681	2018/02/15	17:05:42	47.9	47.5	47.0	46.6	47.8
686	2018/02/15	17:05:47	48.7	47.1	47.5	47.1	47.2
691	2018/02/15	17:05:52	48.6	46.7	46.4	48.0	48.1
696	2018/02/15	17:05:57	46.3	47.5	47.5	46.6	46.3
701	2018/02/15	17:06:02	46.8	46.3	46.3	47.0	48.1
706	2018/02/15	17:06:07	46.3	47.5	47.3	47.5	49.6
711	2018/02/15	17:06:12	48.0	49.3	50.0	48.8	48.8
716	2018/02/15	17:06:17	48.8	49.7	50.2	49.4	49.9
721	2018/02/15	17:06:22	51.4	51.5	52.2	51.7	50.6
726	2018/02/15	17:06:27	50.6	50.8	49.9	49.0	49.7
731	2018/02/15	17:06:32	49.2	49.4	50.3	50.4	48.5
736	2018/02/15	17:06:37	49.4	49.7	49.0	49.1	49.9
741	2018/02/15	17:06:42	51.1	51.1	51.1	49.6	48.8
746	2018/02/15	17:06:47	49.0	49.4	50.1	49.8	48.5
751	2018/02/15	17:06:52	49.4	49.3	50.0	48.8	47.3
756	2018/02/15	17:06:57	47.9	47.6	47.3	46.5	45.2
761	2018/02/15	17:07:02	45.4	44.9	45.7	46.2	47.3
766	2018/02/15	17:07:07	45.5	45.1	45.6	47.1	46.6
771	2018/02/15	17:07:12	49.8	46.9	45.8	46.1	46.9
776	2018/02/15	17:07:17	49.0	47.3	48.7	49.4	50.6
781	2018/02/15	17:07:22	49.2	49.2	48.9	49.0	48.4
786	2018/02/15	17:07:27	50.0	49.6	49.7	49.3	48.3
791	2018/02/15	17:07:32	49.0	48.8	49.2	48.5	48.9
796	2018/02/15	17:07:37	49.6	49.1	50.0	50.0	50.2
801	2018/02/15	17:07:42	51.7	50.0	50.2	50.8	50.5
806	2018/02/15	17:07:47	49.8	50.3	50.3	49.4	48.8
811	2018/02/15	17:07:52	48.9	49.4	49.1	49.6	50.1
816	2018/02/15	17:07:57	51.2	49.9	51.0	50.6	52.0
821	2018/02/15	17:08:02	50.7	52.2	52.0	51.0	51.7
826	2018/02/15	17:08:07	51.1	52.8	52.0	50.0	49.8
831	2018/02/15	17:08:12	49.6	50.3	49.7	48.2	48.7
836	2018/02/15	17:08:17	48.3	47.2	47.2	47.5	48.4
841	2018/02/15	17:08:22	48.6	47.4	48.6	47.3	47.9
846	2018/02/15	17:08:27	48.8	48.6	47.6	48.1	47.7
851	2018/02/15	17:08:32	48.2	48.0	49.7	48.3	48.8
856	2018/02/15	17:08:37	48.8	54.5	49.8	48.6	49.4
861	2018/02/15	17:08:42	50.6	50.5	51.3	51.0	53.1
866	2018/02/15	17:08:47	51.8	50.4	52.8	53.9	54.1
871	2018/02/15	17:08:52	53.2	51.3	50.4	51.1	49.9
876	2018/02/15	17:08:57	50.1	50.6	50.2	50.4	49.6
881	2018/02/15	17:09:02	50.6	51.6	50.0	50.1	50.0
886	2018/02/15	17:09:07	50.4	49.3	49.7	50.7	49.3
891	2018/02/15	17:09:12	50.2	51.0	49.7	49.0	48.6
896	2018/02/15	17:09:17	48.6	49.8	49.0	48.7	48.2

Freq Weight : A
 Time Weight : FAST
 Level Range : 40-100
 Max dB : 88.4 - 2018/02/15 17: 21: 26
 Level Range : 40-100
 SEL : 95.8
 Leq : 66.3

No. s	Date Time	(dB)				
1	2018/02/15 17: 15: 40	60.4	65.6	66.3	63.8	62.6
6	2018/02/15 17: 15: 45	65.9	72.6	68.8	67.2	63.4
11	2018/02/15 17: 15: 50	61.5	64.3	67.5	66.5	66.3
16	2018/02/15 17: 15: 55	66.1	65.5	65.0	64.0	65.6
21	2018/02/15 17: 16: 00	67.4	62.6	61.3	59.2	58.1
26	2018/02/15 17: 16: 05	62.4	69.4	70.4	62.3	57.7
31	2018/02/15 17: 16: 10	57.1	61.6	64.3	71.7	70.7
36	2018/02/15 17: 16: 15	67.7	61.3	57.3	54.3	53.7
41	2018/02/15 17: 16: 20	52.7	53.0	56.5	54.3	53.2
46	2018/02/15 17: 16: 25	54.6	55.2	55.3	60.0	68.0
51	2018/02/15 17: 16: 30	71.3	64.8	62.3	64.0	68.9
56	2018/02/15 17: 16: 35	73.9	64.9	59.8	57.6	58.5
61	2018/02/15 17: 16: 40	61.8	63.4	66.8	74.2	75.3
66	2018/02/15 17: 16: 45	81.2	75.4	65.4	63.2	62.0
71	2018/02/15 17: 16: 50	62.3	62.1	63.1	63.3	63.7
76	2018/02/15 17: 16: 55	64.1	64.1	66.7	75.3	71.2
81	2018/02/15 17: 17: 00	63.3	61.0	60.1	64.3	70.9
86	2018/02/15 17: 17: 05	71.6	63.9	59.2	56.5	55.7
91	2018/02/15 17: 17: 10	57.5	58.9	63.0	71.4	70.7
96	2018/02/15 17: 17: 15	62.3	64.6	69.9	69.7	62.4
101	2018/02/15 17: 17: 20	64.1	68.0	61.0	56.7	54.6
106	2018/02/15 17: 17: 25	54.7	61.9	67.6	64.4	56.6
111	2018/02/15 17: 17: 30	52.2	50.5	51.9	54.7	56.5
116	2018/02/15 17: 17: 35	58.7	63.2	67.7	65.3	63.7
121	2018/02/15 17: 17: 40	65.2	66.7	66.0	65.5	66.9
126	2018/02/15 17: 17: 45	71.2	70.8	67.3	69.2	67.4
131	2018/02/15 17: 17: 50	62.0	57.2	57.4	59.5	55.9
136	2018/02/15 17: 17: 55	52.9	56.9	57.7	55.8	53.0
141	2018/02/15 17: 18: 00	51.5	54.7	52.9	53.6	56.3
146	2018/02/15 17: 18: 05	62.8	71.2	69.2	60.6	56.2
151	2018/02/15 17: 18: 10	55.1	55.4	60.0	70.0	77.5
156	2018/02/15 17: 18: 15	68.1	61.8	61.4	61.9	62.5
161	2018/02/15 17: 18: 20	64.2	66.7	65.0	63.1	64.9
166	2018/02/15 17: 18: 25	71.0	77.5	72.0	70.3	71.0
171	2018/02/15 17: 18: 30	73.0	70.0	66.7	65.1	64.0
176	2018/02/15 17: 18: 35	63.7	60.6	58.7	64.0	71.3
181	2018/02/15 17: 18: 40	66.8	70.8	67.5	61.5	61.8
186	2018/02/15 17: 18: 45	64.2	66.5	64.0	60.3	56.2
191	2018/02/15 17: 18: 50	55.5	55.5	54.0	55.4	53.7
196	2018/02/15 17: 18: 55	52.2	53.0	54.3	57.4	59.8
201	2018/02/15 17: 19: 00	64.3	66.4	60.4	57.4	56.4
206	2018/02/15 17: 19: 05	55.7	55.0	54.8	59.2	65.2
211	2018/02/15 17: 19: 10	67.2	59.2	54.9	52.2	54.7
216	2018/02/15 17: 19: 15	56.1	57.0	58.9	60.5	64.9
221	2018/02/15 17: 19: 20	70.2	77.6	75.8	68.6	68.2
226	2018/02/15 17: 19: 25	67.5	77.1	77.0	71.2	69.0
231	2018/02/15 17: 19: 30	66.7	65.1	67.6	70.3	65.8
236	2018/02/15 17: 19: 35	61.6	59.0	57.3	54.0	57.5
241	2018/02/15 17: 19: 40	54.1	56.3	54.1	55.5	58.0
246	2018/02/15 17: 19: 45	58.7	60.1	62.6	69.2	70.9
251	2018/02/15 17: 19: 50	62.5	57.0	54.8	54.1	53.8
256	2018/02/15 17: 19: 55	53.9	53.2	53.0	56.0	60.6
261	2018/02/15 17: 20: 00	67.3	69.5	60.1	58.3	63.0
266	2018/02/15 17: 20: 05	68.5	61.9	55.3	53.1	51.4
271	2018/02/15 17: 20: 10	50.2	49.4	48.6	48.7	49.2
276	2018/02/15 17: 20: 15	50.9	51.4	53.1	53.3	54.1
281	2018/02/15 17: 20: 20	56.4	62.2	70.0	70.2	67.3
286	2018/02/15 17: 20: 25	72.1	70.1	71.2	68.3	59.3
291	2018/02/15 17: 20: 30	56.1	56.5	64.7	73.5	67.5
296	2018/02/15 17: 20: 35	55.9	50.8	50.7	52.0	55.8
301	2018/02/15 17: 20: 40	61.5	66.7	63.0	54.4	54.8
306	2018/02/15 17: 20: 45	53.6	53.9	51.8	50.8	51.3
311	2018/02/15 17: 20: 50	51.8	51.0	50.7	51.3	52.0
316	2018/02/15 17: 20: 55	51.5	51.5	51.2	51.5	50.9
321	2018/02/15 17: 21: 00	51.8	51.2	51.3	51.7	52.8
326	2018/02/15 17: 21: 05	53.8	56.3	58.4	60.8	63.9
331	2018/02/15 17: 21: 10	66.3	65.0	65.8	64.6	61.1
336	2018/02/15 17: 21: 15	62.6	64.6	65.0	65.4	70.1
341	2018/02/15 17: 21: 20	69.7	65.1	63.9	68.7	76.2
346	2018/02/15 17: 21: 25	80.5	75.2	67.1	73.7	67.7
351	2018/02/15 17: 21: 30	60.4	57.8	55.9	56.3	63.1
356	2018/02/15 17: 21: 35	62.3	69.3	52.0	52.4	51.5
361	2018/02/15 17: 21: 40	52.2	51.1	53.2	55.3	55.7
366	2018/02/15 17: 21: 45	57.0	57.5	61.7	67.3	67.8
371	2018/02/15 17: 21: 50	63.4	58.5	56.8	56.8	56.7
376	2018/02/15 17: 21: 55	54.7	53.9	54.6	54.3	56.6
381	2018/02/15 17: 22: 00	59.3	62.1	62.9	66.0	65.6
386	2018/02/15 17: 22: 05	62.7	57.5	56.9	55.2	55.9
391	2018/02/15 17: 22: 10	53.6	53.8	53.5	52.9	52.4
396	2018/02/15 17: 22: 15	51.7	54.5	53.0	57.6	58.1
401	2018/02/15 17: 22: 20	56.6	56.5	59.9	62.7	69.7
406	2018/02/15 17: 22: 25	75.5	63.3	58.1	57.5	55.4
411	2018/02/15 17: 22: 30	56.0	57.3	60.2	61.8	62.5
416	2018/02/15 17: 22: 35	63.5	67.4	73.7	67.1	67.2
421	2018/02/15 17: 22: 40	75.0	68.6	63.7	64.1	65.3

426	2018/02/15	17: 22: 45	64. 8	65. 7	63. 2	61. 4	59. 0
431	2018/02/15	17: 22: 50	56. 9	54. 9	54. 3	55. 2	56. 3
436	2018/02/15	17: 22: 55	53. 7	56. 0	55. 4	63. 3	71. 0
441	2018/02/15	17: 23: 00	70. 7	61. 5	55. 5	52. 9	50. 9
446	2018/02/15	17: 23: 05	50. 7	48. 8	49. 0	49. 5	50. 1
451	2018/02/15	17: 23: 10	49. 9	49. 7	52. 4	54. 2	56. 6
456	2018/02/15	17: 23: 15	58. 2	61. 0	62. 9	66. 7	68. 2
461	2018/02/15	17: 23: 20	67. 2	65. 7	61. 6	58. 7	55. 5
466	2018/02/15	17: 23: 25	53. 7	52. 3	53. 0	54. 3	54. 2
471	2018/02/15	17: 23: 30	53. 9	55. 7	56. 1	56. 3	55. 8
476	2018/02/15	17: 23: 35	54. 7	54. 5	53. 4	54. 1	55. 5
481	2018/02/15	17: 23: 40	55. 1	56. 8	60. 0	66. 0	72. 2
486	2018/02/15	17: 23: 45	67. 2	63. 0	66. 0	76. 4	71. 9
491	2018/02/15	17: 23: 50	62. 4	59. 1	56. 2	55. 8	55. 4
496	2018/02/15	17: 23: 55	54. 2	53. 5	54. 3	56. 6	53. 9
501	2018/02/15	17: 24: 00	54. 2	54. 2	54. 6	56. 1	54. 3
506	2018/02/15	17: 24: 05	54. 1	53. 0	53. 2	52. 8	51. 9
511	2018/02/15	17: 24: 10	52. 4	51. 8	53. 4	54. 5	58. 0
516	2018/02/15	17: 24: 15	58. 6	59. 1	62. 4	68. 6	72. 5
521	2018/02/15	17: 24: 20	75. 2	77. 6	71. 3	67. 9	64. 2
526	2018/02/15	17: 24: 25	65. 6	63. 4	58. 8	57. 4	57. 7
531	2018/02/15	17: 24: 30	59. 0	62. 6	68. 2	64. 4	61. 5
536	2018/02/15	17: 24: 35	63. 7	62. 1	57. 5	56. 6	57. 0
541	2018/02/15	17: 24: 40	58. 4	60. 3	58. 4	58. 1	58. 4
546	2018/02/15	17: 24: 45	59. 6	59. 5	59. 4	59. 1	61. 7
551	2018/02/15	17: 24: 50	62. 3	63. 7	72. 8	75. 0	71. 3
556	2018/02/15	17: 24: 55	70. 7	68. 8	65. 7	63. 8	58. 9
561	2018/02/15	17: 25: 00	61. 2	66. 1	66. 8	63. 7	69. 6
566	2018/02/15	17: 25: 05	65. 3	61. 5	63. 8	63. 7	68. 6
571	2018/02/15	17: 25: 10	68. 3	68. 5	69. 1	69. 2	69. 6
576	2018/02/15	17: 25: 15	72. 2	70. 2	61. 5	60. 2	67. 7
581	2018/02/15	17: 25: 20	70. 2	59. 9	55. 2	53. 4	52. 4
586	2018/02/15	17: 25: 25	54. 3	52. 5	52. 0	57. 1	52. 4
591	2018/02/15	17: 25: 30	51. 6	51. 1	52. 4	55. 0	54. 3
596	2018/02/15	17: 25: 35	56. 1	55. 5	60. 0	66. 0	68. 6
601	2018/02/15	17: 25: 40	60. 0	56. 6	61. 8	69. 8	67. 0
606	2018/02/15	17: 25: 45	63. 6	67. 8	63. 8	58. 7	63. 3
611	2018/02/15	17: 25: 50	65. 6	57. 7	53. 5	53. 4	54. 0
616	2018/02/15	17: 25: 55	58. 1	59. 3	65. 0	69. 3	66. 8
621	2018/02/15	17: 26: 00	63. 6	59. 9	57. 4	54. 7	53. 0
626	2018/02/15	17: 26: 05	51. 9	51. 7	52. 3	53. 1	53. 8
631	2018/02/15	17: 26: 10	53. 9	53. 3	54. 5	54. 9	54. 2
636	2018/02/15	17: 26: 15	60. 3	67. 7	74. 3	67. 7	59. 8
641	2018/02/15	17: 26: 20	57. 1	58. 8	59. 0	66. 3	73. 4
646	2018/02/15	17: 26: 25	65. 1	59. 1	57. 0	55. 4	54. 9
651	2018/02/15	17: 26: 30	54. 3	54. 7	55. 5	54. 0	53. 9
656	2018/02/15	17: 26: 35	53. 6	53. 6	54. 3	54. 4	54. 1
661	2018/02/15	17: 26: 40	56. 2	57. 0	62. 6	69. 3	69. 5
666	2018/02/15	17: 26: 45	60. 7	55. 9	61. 6	63. 9	72. 1
671	2018/02/15	17: 26: 50	70. 4	61. 2	56. 3	56. 6	59. 1
676	2018/02/15	17: 26: 55	63. 7	71. 6	70. 3	66. 3	66. 1
681	2018/02/15	17: 27: 00	66. 6	66. 3	65. 6	63. 8	62. 1
686	2018/02/15	17: 27: 05	64. 7	73. 5	75. 1	66. 6	62. 4
691	2018/02/15	17: 27: 10	61. 9	59. 7	57. 2	57. 1	64. 9
696	2018/02/15	17: 27: 15	73. 1	70. 9	61. 4	57. 7	55. 8
701	2018/02/15	17: 27: 20	53. 4	55. 4	56. 7	59. 9	65. 3
706	2018/02/15	17: 27: 25	73. 6	67. 2	60. 6	59. 6	57. 1
711	2018/02/15	17: 27: 30	57. 7	56. 8	55. 6	57. 0	54. 6
716	2018/02/15	17: 27: 35	52. 7	53. 1	51. 3	53. 2	51. 1
721	2018/02/15	17: 27: 40	50. 9	51. 8	54. 0	54. 8	61. 8
726	2018/02/15	17: 27: 45	72. 2	69. 2	58. 6	53. 1	52. 5
731	2018/02/15	17: 27: 50	53. 2	53. 2	55. 5	55. 9	58. 2
736	2018/02/15	17: 27: 55	60. 5	61. 3	66. 3	70. 2	67. 3
741	2018/02/15	17: 28: 00	65. 9	67. 4	68. 2	67. 0	68. 9
746	2018/02/15	17: 28: 05	67. 0	67. 4	66. 7	73. 0	68. 0
751	2018/02/15	17: 28: 10	61. 3	57. 4	54. 1	53. 1	57. 3
756	2018/02/15	17: 28: 15	57. 9	56. 2	54. 1	55. 7	56. 6
761	2018/02/15	17: 28: 20	58. 2	60. 0	62. 5	60. 5	61. 1
766	2018/02/15	17: 28: 25	60. 7	57. 9	56. 4	55. 0	57. 1
771	2018/02/15	17: 28: 30	60. 6	69. 3	72. 7	61. 9	57. 0
776	2018/02/15	17: 28: 35	57. 1	57. 2	55. 2	55. 8	58. 6
781	2018/02/15	17: 28: 40	65. 1	71. 7	67. 4	57. 8	68. 9
786	2018/02/15	17: 28: 45	56. 5	60. 5	62. 7	66. 8	69. 9
791	2018/02/15	17: 28: 50	67. 6	61. 1	56. 9	63. 3	57. 6
796	2018/02/15	17: 28: 55	60. 0	61. 2	65. 8	70. 3	67. 8
801	2018/02/15	17: 29: 00	66. 4	63. 5	59. 0	56. 1	53. 4
806	2018/02/15	17: 29: 05	58. 1	52. 8	52. 8	53. 7	56. 8
811	2018/02/15	17: 29: 10	59. 3	69. 7	73. 4	62. 2	55. 7
816	2018/02/15	17: 29: 15	54. 0	52. 9	54. 2	54. 7	56. 0
821	2018/02/15	17: 29: 20	58. 4	64. 0	68. 1	62. 5	61. 5
826	2018/02/15	17: 29: 25	56. 7	56. 9	55. 0	54. 2	53. 1
831	2018/02/15	17: 29: 30	50. 7	50. 3	50. 7	50. 1	52. 5
836	2018/02/15	17: 29: 35	52. 7	57. 0	54. 6	54. 4	56. 1
841	2018/02/15	17: 29: 40	59. 2	61. 0	65. 5	67. 6	69. 1
846	2018/02/15	17: 29: 45	66. 9	71. 5	77. 8	67. 1	60. 1
851	2018/02/15	17: 29: 50	56. 4	52. 7	53. 5	55. 7	66. 6
856	2018/02/15	17: 29: 55	73. 4	63. 1	58. 0	59. 0	58. 9
861	2018/02/15	17: 30: 00	54. 4	55. 3	53. 2	53. 3	51. 7
866	2018/02/15	17: 30: 05	51. 6	51. 5	51. 9	51. 5	52. 5
871	2018/02/15	17: 30: 10	52. 5	53. 1	52. 6	51. 1	50. 7
876	2018/02/15	17: 30: 15	51. 0	50. 9	50. 7	51. 3	51. 1
881	2018/02/15	17: 30: 20	51. 9	51. 8	54. 3	57. 0	58. 9
886	2018/02/15	17: 30: 25	63. 2	69. 4	66. 8	61. 5	60. 3
891	2018/02/15	17: 30: 30	63. 4	66. 9	66. 0	66. 5	67. 5
896	2018/02/15	17: 30: 35	67. 9	67. 0	66. 9	65. 3	65. 0

Freq Weight : A
 Time Weight : FAST
 Level Range : 40-100
 Max dB : 86.4 - 2018/02/15 17: 40: 59
 Level Range : 40-100
 SEL : 95.4
 Leq : 66.0

No. s	Date Time	(dB)				
1	2018/02/15 17: 34: 58	56.1	56.7	57.4	57.9	58.4
6	2018/02/15 17: 35: 03	56.6	56.6	54.3	52.9	51.7
11	2018/02/15 17: 35: 08	53.9	57.1	56.6	57.6	59.5
16	2018/02/15 17: 35: 13	62.6	70.6	68.5	70.9	66.2
21	2018/02/15 17: 35: 18	59.5	57.6	56.7	55.5	56.4
26	2018/02/15 17: 35: 23	57.6	56.2	58.9	60.1	61.4
31	2018/02/15 17: 35: 28	62.7	57.9	57.4	57.8	63.1
36	2018/02/15 17: 35: 33	68.5	66.4	60.7	60.0	60.6
41	2018/02/15 17: 35: 38	59.5	63.8	68.5	63.5	60.6
46	2018/02/15 17: 35: 43	61.6	61.1	63.1	68.7	70.9
51	2018/02/15 17: 35: 48	63.0	61.1	60.9	59.5	58.7
56	2018/02/15 17: 35: 53	56.8	55.9	54.9	55.4	58.2
61	2018/02/15 17: 35: 58	56.7	54.8	56.1	55.4	54.9
66	2018/02/15 17: 36: 03	56.7	56.4	56.4	56.8	58.2
71	2018/02/15 17: 36: 08	60.1	62.2	62.4	68.0	67.8
76	2018/02/15 17: 36: 13	64.9	71.3	68.9	69.5	62.5
81	2018/02/15 17: 36: 18	58.7	56.5	55.2	53.7	54.5
86	2018/02/15 17: 36: 23	54.4	56.7	57.8	61.5	61.0
91	2018/02/15 17: 36: 28	59.8	54.9	53.9	54.1	51.4
96	2018/02/15 17: 36: 33	54.0	55.7	50.0	50.2	52.7
101	2018/02/15 17: 36: 38	53.4	51.5	55.9	58.0	57.6
106	2018/02/15 17: 36: 43	59.0	65.2	71.5	65.3	66.1
111	2018/02/15 17: 36: 48	68.7	63.3	66.3	70.7	66.2
116	2018/02/15 17: 36: 53	62.2	62.7	61.5	60.6	59.5
121	2018/02/15 17: 36: 58	61.1	63.0	63.5	64.5	70.1
126	2018/02/15 17: 37: 03	68.3	63.9	61.7	60.1	57.4
131	2018/02/15 17: 37: 08	55.7	55.2	55.4	56.4	55.7
136	2018/02/15 17: 37: 13	56.4	55.4	56.3	59.9	55.8
141	2018/02/15 17: 37: 18	55.3	54.2	55.0	56.8	54.2
146	2018/02/15 17: 37: 23	57.8	53.8	53.0	55.2	57.2
151	2018/02/15 17: 37: 28	54.8	57.2	55.1	56.7	57.6
156	2018/02/15 17: 37: 33	54.5	55.2	51.2	49.4	50.6
161	2018/02/15 17: 37: 38	54.4	53.8	56.4	59.9	62.6
166	2018/02/15 17: 37: 43	66.1	76.4	68.6	63.4	60.2
171	2018/02/15 17: 37: 48	58.2	57.1	56.3	54.0	56.1
176	2018/02/15 17: 37: 53	53.8	56.4	57.7	56.7	59.8
181	2018/02/15 17: 37: 58	63.4	60.2	56.3	60.8	61.8
186	2018/02/15 17: 38: 03	60.2	63.2	63.9	59.6	58.0
191	2018/02/15 17: 38: 08	54.7	54.2	54.1	53.4	53.7
196	2018/02/15 17: 38: 13	53.9	54.6	56.6	57.3	56.5
201	2018/02/15 17: 38: 18	56.7	56.1	56.6	56.5	55.4
206	2018/02/15 17: 38: 23	55.7	56.3	57.9	57.7	59.9
211	2018/02/15 17: 38: 28	60.2	64.9	69.5	68.0	65.1
216	2018/02/15 17: 38: 33	60.9	58.5	58.0	56.9	55.6
221	2018/02/15 17: 38: 38	55.5	53.2	53.2	54.2	55.5
226	2018/02/15 17: 38: 43	59.2	64.1	69.5	64.2	59.5
231	2018/02/15 17: 38: 48	59.2	58.3	59.6	61.0	61.5
236	2018/02/15 17: 38: 53	61.5	60.5	59.7	60.5	61.2
241	2018/02/15 17: 38: 58	62.6	64.0	66.8	73.6	78.1
246	2018/02/15 17: 39: 03	66.9	61.5	59.7	55.9	56.4
251	2018/02/15 17: 39: 08	55.0	54.6	53.9	56.0	55.6
256	2018/02/15 17: 39: 13	53.2	54.4	57.5	57.5	59.3
261	2018/02/15 17: 39: 18	58.3	67.4	59.3	59.9	63.6
266	2018/02/15 17: 39: 23	71.1	67.6	60.5	59.4	61.2
271	2018/02/15 17: 39: 28	64.3	68.1	63.3	60.5	58.3
276	2018/02/15 17: 39: 33	56.4	55.5	54.4	54.9	54.5
281	2018/02/15 17: 39: 38	53.7	52.9	53.0	55.0	59.0
286	2018/02/15 17: 39: 43	64.8	70.2	61.7	57.0	58.2
291	2018/02/15 17: 39: 48	60.1	64.2	69.7	69.7	72.8
296	2018/02/15 17: 39: 53	69.4	70.0	64.8	65.8	71.2
301	2018/02/15 17: 39: 58	67.7	63.4	62.7	63.8	63.0
306	2018/02/15 17: 40: 03	58.9	55.9	53.4	52.0	51.8
311	2018/02/15 17: 40: 08	52.9	53.8	52.6	53.8	52.4
316	2018/02/15 17: 40: 13	52.6	53.1	53.8	54.6	58.6
321	2018/02/15 17: 40: 18	62.0	62.7	68.7	72.2	64.6
326	2018/02/15 17: 40: 23	60.3	59.0	56.4	55.7	54.3
331	2018/02/15 17: 40: 28	54.5	52.1	59.4	51.7	52.2
336	2018/02/15 17: 40: 33	56.2	59.4	62.5	69.1	75.3
341	2018/02/15 17: 40: 38	68.8	62.4	60.1	58.5	55.9
346	2018/02/15 17: 40: 43	55.5	52.4	53.6	58.0	58.5
351	2018/02/15 17: 40: 48	61.3	63.9	68.4	77.8	72.4
356	2018/02/15 17: 40: 53	70.8	67.4	64.6	63.6	68.4
361	2018/02/15 17: 40: 58	81.4	83.5	67.3	65.0	65.3
366	2018/02/15 17: 41: 03	71.4	67.5	68.9	67.7	64.3
371	2018/02/15 17: 41: 08	69.3	71.6	61.9	59.3	58.0
376	2018/02/15 17: 41: 13	57.4	58.9	59.5	59.2	60.3
381	2018/02/15 17: 41: 18	61.2	64.6	66.1	63.0	62.8
386	2018/02/15 17: 41: 23	63.1	63.8	63.2	62.2	60.5
391	2018/02/15 17: 41: 28	60.6	60.5	60.9	62.0	62.8
396	2018/02/15 17: 41: 33	62.9	63.1	65.4	71.0	65.7
401	2018/02/15 17: 41: 38	62.3	63.4	68.1	70.3	62.9
406	2018/02/15 17: 41: 43	63.3	60.2	59.3	59.5	61.6
411	2018/02/15 17: 41: 48	65.6	70.3	65.8	68.9	69.2
416	2018/02/15 17: 41: 53	69.8	68.2	73.0	65.9	61.4
421	2018/02/15 17: 41: 58	61.3	66.2	70.8	64.9	59.2

426	2018/02/15	17: 42: 03	59.0	58.1	57.9	58.7	56.9
431	2018/02/15	17: 42: 08	55.3	56.0	59.3	63.0	65.7
436	2018/02/15	17: 42: 13	59.6	59.0	58.1	59.2	62.2
441	2018/02/15	17: 42: 18	68.4	65.1	62.1	65.7	68.8
446	2018/02/15	17: 42: 23	62.6	62.2	67.4	65.8	60.6
451	2018/02/15	17: 42: 28	65.8	73.7	63.9	61.8	61.8
456	2018/02/15	17: 42: 33	62.3	68.4	68.8	63.4	63.7
461	2018/02/15	17: 42: 38	65.7	65.5	64.8	64.7	63.4
466	2018/02/15	17: 42: 43	63.3	65.1	68.2	64.5	60.8
471	2018/02/15	17: 42: 48	60.2	63.4	69.4	65.6	68.2
476	2018/02/15	17: 42: 53	65.8	66.0	69.2	63.6	57.9
481	2018/02/15	17: 42: 58	56.9	55.0	53.4	53.3	52.5
486	2018/02/15	17: 43: 03	53.0	54.2	54.1	53.5	53.3
491	2018/02/15	17: 43: 08	52.5	52.6	52.1	52.3	55.1
496	2018/02/15	17: 43: 13	55.1	54.3	53.7	52.8	57.5
501	2018/02/15	17: 43: 18	57.0	53.7	56.1	55.1	55.0
506	2018/02/15	17: 43: 23	55.8	59.0	58.9	54.2	58.9
511	2018/02/15	17: 43: 28	57.2	56.6	57.9	56.4	55.1
516	2018/02/15	17: 43: 33	54.6	57.7	56.5	55.8	59.3
521	2018/02/15	17: 43: 38	62.1	63.4	64.2	62.9	62.7
526	2018/02/15	17: 43: 43	63.7	64.8	66.3	70.7	69.2
531	2018/02/15	17: 43: 48	66.1	72.0	67.8	69.8	67.7
536	2018/02/15	17: 43: 53	70.6	65.8	67.0	69.2	66.0
541	2018/02/15	17: 43: 58	60.0	62.7	63.5	62.0	65.8
546	2018/02/15	17: 44: 03	63.7	61.3	63.2	62.6	56.4
551	2018/02/15	17: 44: 08	56.8	56.7	57.2	58.9	60.1
556	2018/02/15	17: 44: 13	61.0	60.5	57.5	56.5	54.4
561	2018/02/15	17: 44: 18	53.5	54.5	54.4	53.8	53.8
566	2018/02/15	17: 44: 23	53.9	54.1	54.9	56.3	57.3
571	2018/02/15	17: 44: 28	60.7	64.6	65.9	62.3	59.9
576	2018/02/15	17: 44: 33	59.7	62.2	68.2	70.1	65.1
581	2018/02/15	17: 44: 38	68.6	71.4	64.8	62.5	64.6
586	2018/02/15	17: 44: 43	61.2	59.0	60.2	67.3	68.1
591	2018/02/15	17: 44: 48	61.4	59.5	59.5	60.1	59.8
596	2018/02/15	17: 44: 53	60.7	61.7	62.1	60.7	57.9
601	2018/02/15	17: 44: 58	55.0	50.7	52.0	56.5	52.0
606	2018/02/15	17: 45: 03	56.2	55.2	54.4	58.7	66.5
611	2018/02/15	17: 45: 08	66.6	61.0	59.7	61.4	67.3
616	2018/02/15	17: 45: 13	67.9	64.6	68.5	68.4	66.6
621	2018/02/15	17: 45: 18	63.8	60.3	60.2	61.2	66.4
626	2018/02/15	17: 45: 23	65.4	59.1	55.8	56.3	56.9
631	2018/02/15	17: 45: 28	56.9	58.1	57.8	61.5	68.7
636	2018/02/15	17: 45: 33	66.2	57.3	55.9	54.7	53.6
641	2018/02/15	17: 45: 38	53.2	52.5	51.7	51.8	53.8
646	2018/02/15	17: 45: 43	57.1	52.7	55.5	54.9	49.3
651	2018/02/15	17: 45: 48	48.8	48.5	48.0	48.2	48.9
656	2018/02/15	17: 45: 53	51.4	52.2	53.7	54.2	57.4
661	2018/02/15	17: 45: 58	60.7	69.8	68.5	69.7	64.8
666	2018/02/15	17: 46: 03	62.5	67.7	65.7	61.2	60.7
671	2018/02/15	17: 46: 08	61.3	60.6	56.6	52.4	51.3
676	2018/02/15	17: 46: 13	52.1	54.9	57.1	57.8	58.5
681	2018/02/15	17: 46: 18	59.8	61.6	61.7	61.6	63.9
686	2018/02/15	17: 46: 23	70.7	68.2	63.1	64.4	67.0
691	2018/02/15	17: 46: 28	70.4	64.2	60.7	60.5	61.2
696	2018/02/15	17: 46: 33	64.2	67.8	62.3	58.9	64.8
701	2018/02/15	17: 46: 38	64.9	62.9	63.7	67.9	73.0
706	2018/02/15	17: 46: 43	64.2	62.9	71.2	68.9	62.0
711	2018/02/15	17: 46: 48	60.2	58.6	56.1	54.6	54.8
716	2018/02/15	17: 46: 53	56.6	57.6	58.3	59.1	60.0
721	2018/02/15	17: 46: 58	62.9	72.4	69.1	60.9	59.6
726	2018/02/15	17: 47: 03	61.7	62.1	65.8	67.5	61.6
731	2018/02/15	17: 47: 08	57.6	60.6	59.9	60.1	60.4
736	2018/02/15	17: 47: 13	61.6	62.1	62.8	65.3	60.7
741	2018/02/15	17: 47: 18	62.5	64.9	73.3	76.5	66.6
746	2018/02/15	17: 47: 23	64.6	62.3	63.5	62.2	64.5
751	2018/02/15	17: 47: 28	68.0	62.3	62.5	63.4	62.2
756	2018/02/15	17: 47: 33	61.6	59.8	59.5	62.9	63.1
761	2018/02/15	17: 47: 38	61.8	57.9	59.1	58.3	57.9
766	2018/02/15	17: 47: 43	57.5	56.2	55.0	54.7	55.1
771	2018/02/15	17: 47: 48	58.9	59.4	64.2	68.5	73.9
776	2018/02/15	17: 47: 53	79.4	73.3	67.5	63.9	61.5
781	2018/02/15	17: 47: 58	60.6	58.3	57.8	58.9	62.0
786	2018/02/15	17: 48: 03	70.9	70.9	63.1	68.6	67.5
791	2018/02/15	17: 48: 08	68.3	68.2	65.4	68.4	63.8
796	2018/02/15	17: 48: 13	62.4	62.0	61.8	64.1	70.9
801	2018/02/15	17: 48: 18	72.1	70.6	70.7	68.6	69.7
806	2018/02/15	17: 48: 23	71.8	74.9	84.7	81.2	72.6
811	2018/02/15	17: 48: 28	67.3	64.4	61.9	61.5	62.8
816	2018/02/15	17: 48: 33	64.2	62.1	61.5	60.8	59.8
821	2018/02/15	17: 48: 38	60.8	61.8	61.7	60.8	60.2
826	2018/02/15	17: 48: 43	59.5	59.4	60.9	61.7	59.8
831	2018/02/15	17: 48: 48	57.6	59.9	58.5	57.8	58.0
836	2018/02/15	17: 48: 53	57.3	58.5	60.6	62.5	67.3
841	2018/02/15	17: 48: 58	72.2	66.0	66.2	68.1	62.2
846	2018/02/15	17: 49: 03	58.8	58.1	57.8	58.1	57.6
851	2018/02/15	17: 49: 08	57.8	58.1	59.2	61.2	56.8
856	2018/02/15	17: 49: 13	59.5	65.2	63.0	66.4	60.5
861	2018/02/15	17: 49: 18	61.5	62.9	67.1	73.4	71.4
866	2018/02/15	17: 49: 23	69.4	69.8	66.9	70.6	63.8
871	2018/02/15	17: 49: 28	59.0	57.5	58.3	56.7	56.3
876	2018/02/15	17: 49: 33	58.9	63.4	69.1	65.3	65.2
881	2018/02/15	17: 49: 38	70.8	64.1	62.8	61.2	59.4
886	2018/02/15	17: 49: 43	57.3	58.3	59.4	59.1	60.6
891	2018/02/15	17: 49: 48	61.5	67.7	70.0	61.9	60.4
896	2018/02/15	17: 49: 53	59.5	59.1	67.1	68.3	79.5

Appendix D

Transportation Assessment



155 GRAND AVENUE, SUITE 900
OAKLAND, CA 94612
P 510.839.1742 F 510.839.0871

MEMORANDUM

Date: April 23, 2018

Project #: 22304

To: Abe Leider and Karly Kaufman, Rincon Consultants, Inc.

From: Damian Stefanakis and Michael Sahimi, Kittelson and Associates, Inc.

Project: Hayward B St. & 4th St. Residential Development

Subject: Transportation Impact Memo – Final

This memorandum summarizes the transportation assessment for the proposed B Street & 4th Street Residential Development (“Project”) at Tract 8427 and APNs 427-36-33-5, 427-36-33-6, 427-36-33-7, 427-36-85-1, and 427-36-55-19 in Hayward, CA. The purpose of this memorandum is to:

- Assess potential impacts to traffic operations at study intersections along 4th Street.
- Evaluate potential access and circulation impacts to people driving, bicycling, walking, or taking transit to, from, or near the Project.
- Explore opportunities to enact traffic calming measures in the study area.

PROJECT DESCRIPTION AND LOCATION

Dutra Enterprises, Inc. is proposing to entitle 41 single-family housing units on an approximately five-acre site at the intersection of 4th Street & B Street in Hayward, CA. The project is split into a 3.44-acre portion at the northeast intersection quadrant and a 1.55-acre portion at the southwest intersection quadrant. Project access to the southern portion of the site will be provided by two driveways located on B Street. Project access to the northern portion of the site will be provided by two driveways, one located on B Street and one via the existing Chestnut Street. The Project site plan is shown on Figure 1.

The Project is located in Hayward less than a mile south of the I-580 freeway and less than two miles east of I-880. These freeways are the primary routes leading to destinations such as Dublin, Pleasanton, Silicon Valley, and Oakland. The site is currently vacant. The site is surrounded by single-family residential and commercial uses. San Lorenzo Creek runs along the northern boundary of the Project. Currently, the Project site is zoned Single Family Residential and is located within the Hayward Foothills Trail Special Design District, which was developed to ensure the orderly development of a continuous trail as properties involved in the 238 Bypass Land Use Study are developed.

The Project location is shown on Figure 2.

Figure 1 Project Site Plan

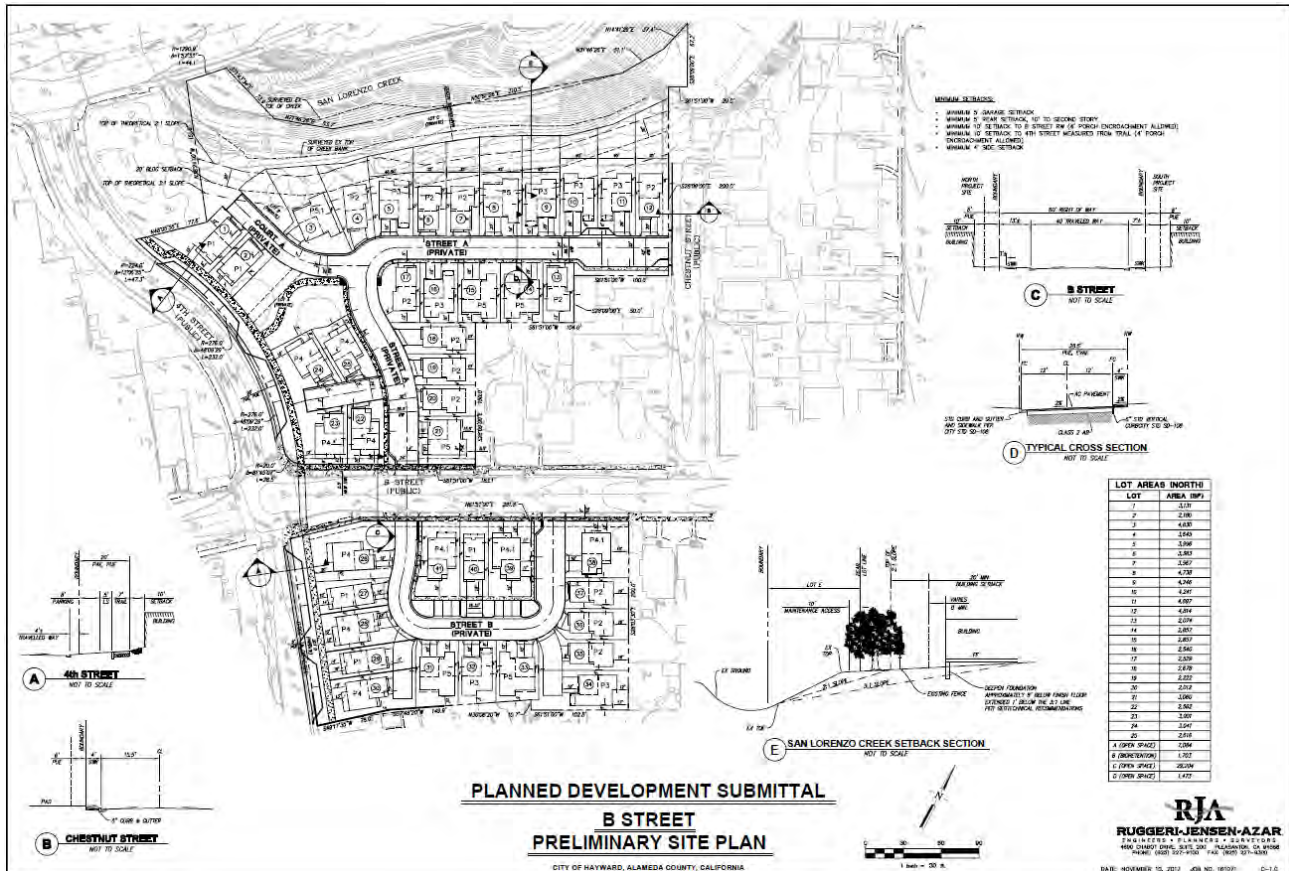

Source: Dutra Enterprises, November 2017

Figure 2 Project Location and Study Area



Source: Kittelson and Associates, Inc., 2018

INTERSECTION OPERATIONAL ANALYSIS

The intersections of 4th Street & A Street, 4th Street & B Street, and 4th Street & C Street were analyzed using Synchro intersection analysis software to determine the impact of the Project on intersection operations, including level of service and delay. The intersections were assessed using the Highway Capacity (HCM) 2010 methodology. The HCM 2010 methodology assigns a level of service (LOS) grade (from A to F) to an intersection based on the average control delay for vehicles at the intersection. Based on the latest City General Plan and Traffic Impact Study Guidelines, LOS E is the minimum acceptable level of service for intersections in Hayward. LOS grades and corresponding delay values under the HCM 2010 methodology are provided in Table 1.

The all-way stop-controlled intersection of 4th Street and C Street was also examined to see if volumes triggered a traffic signal warrant or pedestrian signal warrant.

In addition, 95th percentile queue lengths for movements with turn pockets at the three study intersections were assessed. These 95th percentile queue lengths determine the theoretical “maximum” queue.

Table 1 Intersection Level of Service and Delay Thresholds (HCM 2010 Methodology)

LOS	Average Control Delay Per Vehicle (Seconds)	
	Signalized	Unsignalized
A	<10.0	<10.0
B	>10.0 and <20.0	>10.0 and <15.0
C	>20.0 and <35.0	>15.0 and <25.0
D	>35.0 and <55.0	>25.0 and <35.0
E	>55.0 and <80.0	>35.0 and <50.0
F	>80.0	>50.0

Source: Highway Capacity Manual

Existing Conditions

This section documents the results of the analysis during Existing Conditions (No Project).

Existing Traffic Volumes

Turning movement counts were collected on Tuesday, January 23, 2018, which represents a typical weekday. Conditions on that day were clear without any extreme weather and all schools were in session. Turning movement counts were collected during the AM peak period (7:00 AM to 9:00 AM) and PM peak period (4:00 PM to 6:00 PM). The AM and PM peak hour volumes, lane configurations, and intersection controls are shown on Figure 3. The detailed intersection count sheets are attached to this memorandum.

Figure 3 Existing Traffic Volumes

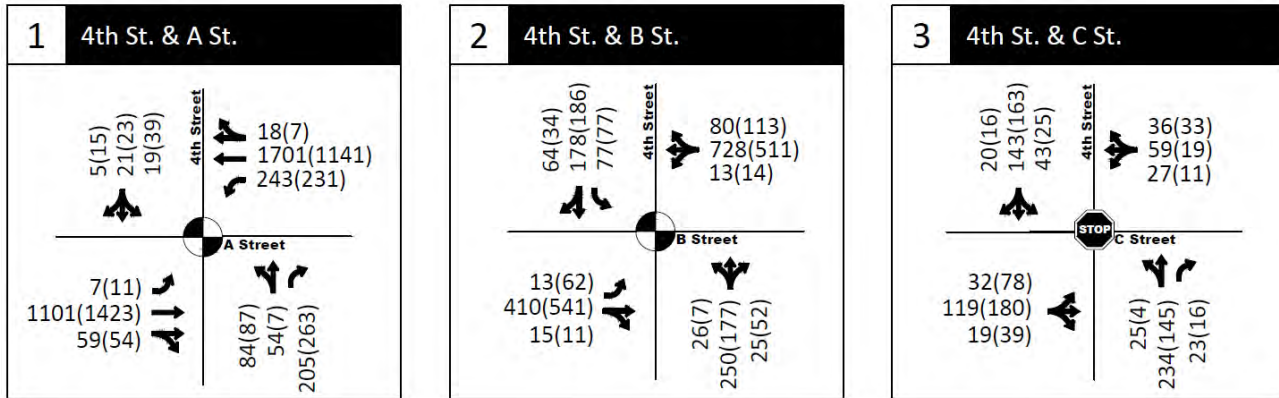

AM(PM) - Traffic Volume
 - All-Way Stop
 - Traffic Signal

Source: Kittelson and Associates, Inc., 2018

Existing Level of Service

Existing LOS for the study intersections is shown in Table 2. As shown in the table, all intersections operate acceptably (LOS E or better) in the AM and PM peak hours.

Table 2 Level of Service – Existing Conditions

Intersection	Traffic Control	Peak Hour	Delay	LOS
1.4 th Street & A Street	Signal	AM	19.5	B
		PM	23.8	C
2.4 th Street & B Street	Signal	AM	12.3	B
		PM	8.9	A
3.4 th Street & C Street	AWSC	AM	12.9	B
		PM	11.6	B

Bold indicates unacceptable LOS.
 AWSC denotes All-Way Stop Control.
 Source: Kittelson & Associates, Inc., 2018

Existing Traffic Warrants

Traffic signal and pedestrian signal warrants for the intersection of 4th Street & C Street are shown in Table 3. Vehicular and pedestrian volumes at this all-way stop-controlled intersection do not trigger a traffic signal warrant or pedestrian signal warrant in either peak hour.

Table 3 Intersection Traffic Warrants -- Existing Conditions

Intersection	Traffic Control	Peak Hour	Traffic Signal Warrant	Pedestrian Signal Warrant
3. 4th Street & C Street	AWSC	AM	No	No
		PM	No	No

Bold indicates a triggered warrant.

AWSC denotes All-Way Stop Control.

Source: Kittelson & Associates, Inc., 2018

Existing Queuing

The 95th percentile queue lengths for turning movements with turn pockets at the three study intersections are shown in Table 4. As shown in the table, the queue lengths do not exceed turn pocket storage lengths at any locations except for one. The AM and PM peak hour queues for westbound left turning vehicles at the intersection of 4th Street & A Street exceed the turn pocket storage length.

Table 4 Queuing – Existing Conditions

Intersection	Movement	Pocket Length	Peak Hour	Queue
1. 4 th Street & A Street	Northbound Right	95'	AM	62'
			PM	59'
	Eastbound Left	70'	AM	<25'
			PM	25'
	Westbound Left	110'	AM	273'
			PM	212'
2. 4th Street & B Street	Southbound Left	105'	AM	63'
			PM	56'
	Eastbound Left	130'	AM	<25'
			PM	28'
3. 4th Street & C Street	Northbound Right	35'	AM	<25'
			PM	<25'

Notes:

All queues are 95th percentile lengths and are presented in feet.

Bold indicates queue exceeding storage length.

Source: Kittelson & Associates, Inc., 2018

Project Trips

This section presents the estimated number of vehicle trips expected to be generated by the Project, which consists of 41 single-family housing units.

Trip Generation

The number of vehicle trips expected to be generated by the Project were estimated using rates published in the Institute of Transportation Engineers (ITE) Trip Generation Manual 10th Edition. The resulting trip generation estimates are shown in Table 5. As shown, the Project is expected to generate 34 trips during the AM peak hour (9 inbound and 25 outbound) and 43 trips in the PM peak hour (27 inbound and 16 outbound). Trip generation estimates were verified with City Transportation staff prior to the analysis commencing.

Table 5 Project Trip Generation Estimates

Trip Generation Rates									
Land Use	Rate	Daily	AM Peak Hour			PM Peak Hour			
			In	Out	Total	In	Out	Total	
Single-Family Detached Housing (ITE Code 210)	per du	[a]	25%	75%	[b]	63%	37%	[c]	
Trip Generation Estimates									
Land Use	Size		Daily	AM Peak Hour			PM Peak Hour		
				In	Out	Total	In	Out	Total
Single-Family Detached Housing (ITE Code 210)	41	DU	458	9	25	34	27	16	43

Source: ITE Trip Generation Manual, 10th Editions

Notes:

du – dwelling units

[a] Daily trip generation for Single-Family Detached Housing is calculated using the equation $\ln(T)=0.92*\ln(X)+2.71$

[b] AM peak hour trip generation for Single-Family Detached Housing is calculated using the equation $T=0.71(X)+4.80$

[c] PM peak hour trip generation for Single-Family Detached Housing is calculated using the equation $\ln(T)=0.96*\ln(X)+0.20$

Kittelson and Associates, Inc., 2018

Trip Distribution and Assignment

The trip distribution for the Project was developed using the City of Hayward General Plan travel demand model. The Project trip distribution is based on the model's distribution of trips in and out of the traffic analysis zone (TAZ 655) representing the project site. The trip distribution for the project is as follows and is displayed on Figure 4:

- 18% to/from the northwest along A Street
- 8% to/from the northeast along A Street
- 25% to/from the west along B Street
- 20% to/from the east along B Street

- 4% to/from the southwest along C Street
- 1% to/from the southeast along C Street
- 24% to/from the south along 4th Street

Trip distribution estimates were verified with City Transportation staff prior to the analysis commencing.

Figure 4 Project Trip Distribution

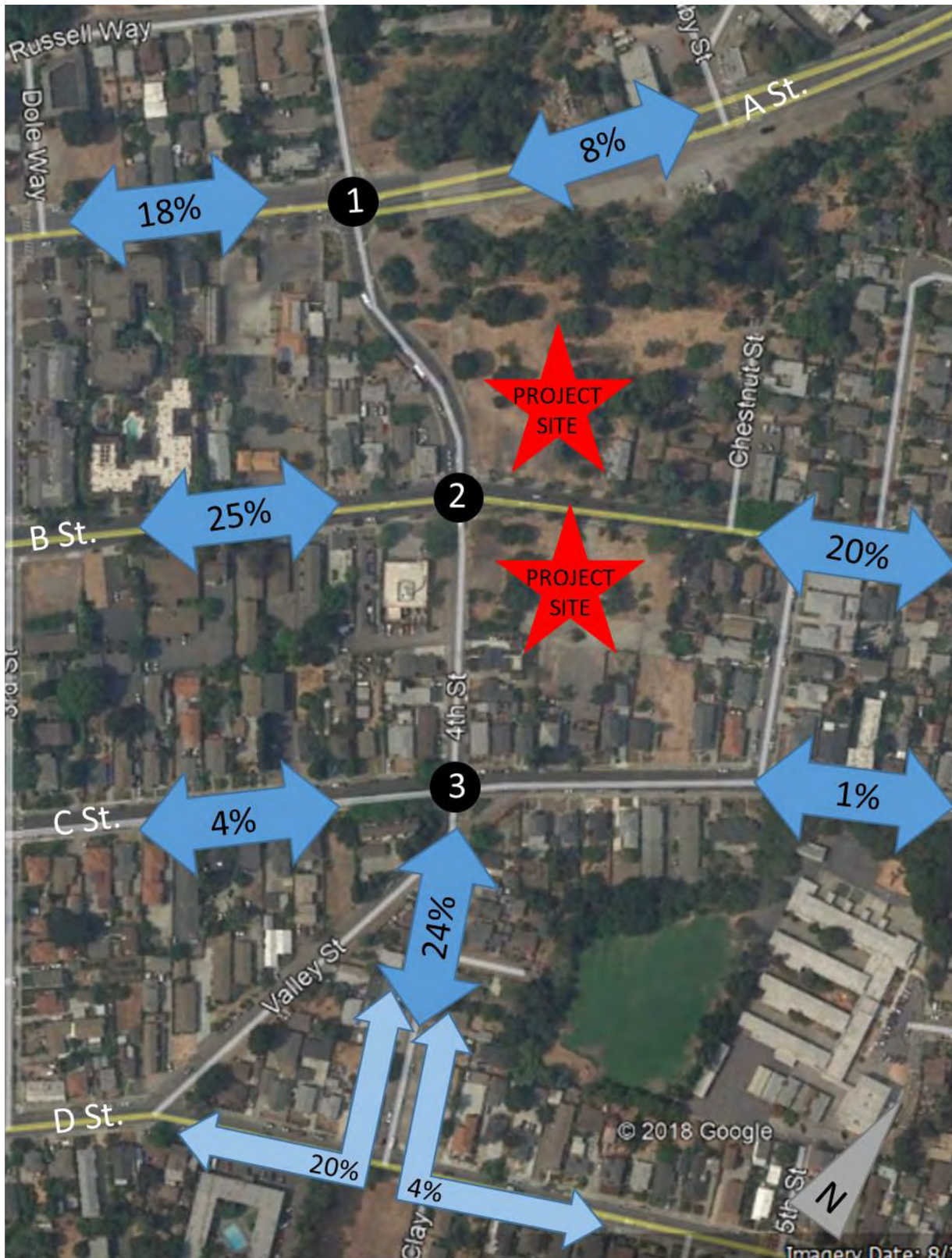

Source: Kittelson and Associates, Inc., 2018 & City of Hayward General Plan Travel Demand Model

The trip distribution was applied to the Project trip generation from Table 5. The resulting Project-only trips at the study intersections are presented on Figure 5. In addition, Project-only trips at the project driveways and at the intersection of B Street & Chestnut Street are shown on Figure 6.

Figure 5 Project-Only Traffic Volumes (Study Intersections)

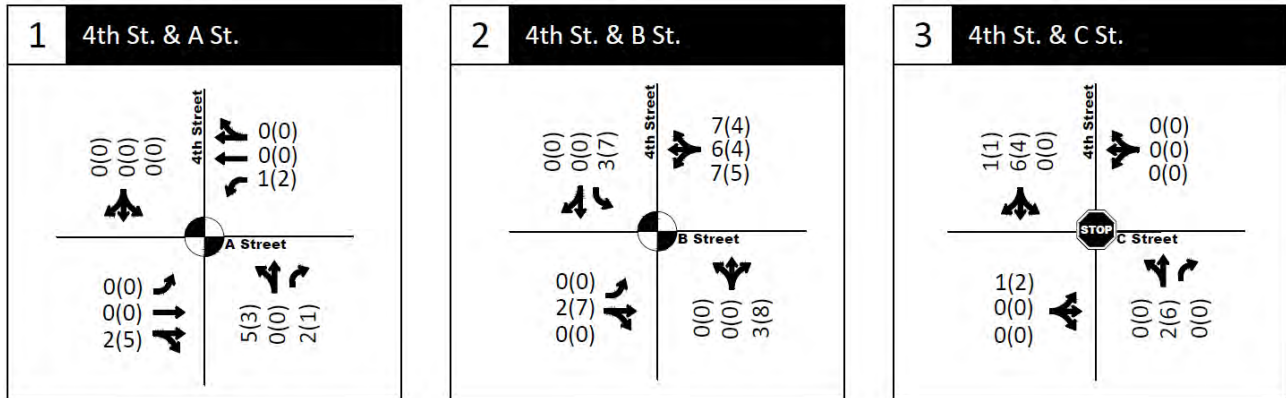

AM(PM) - Traffic Volume
 - All-Way Stop
 - Traffic Signal

Source: Kittelson and Associates, Inc., 2018

Figure 6 Project-Only Traffic Volumes (Project Driveways and Chestnut Street)

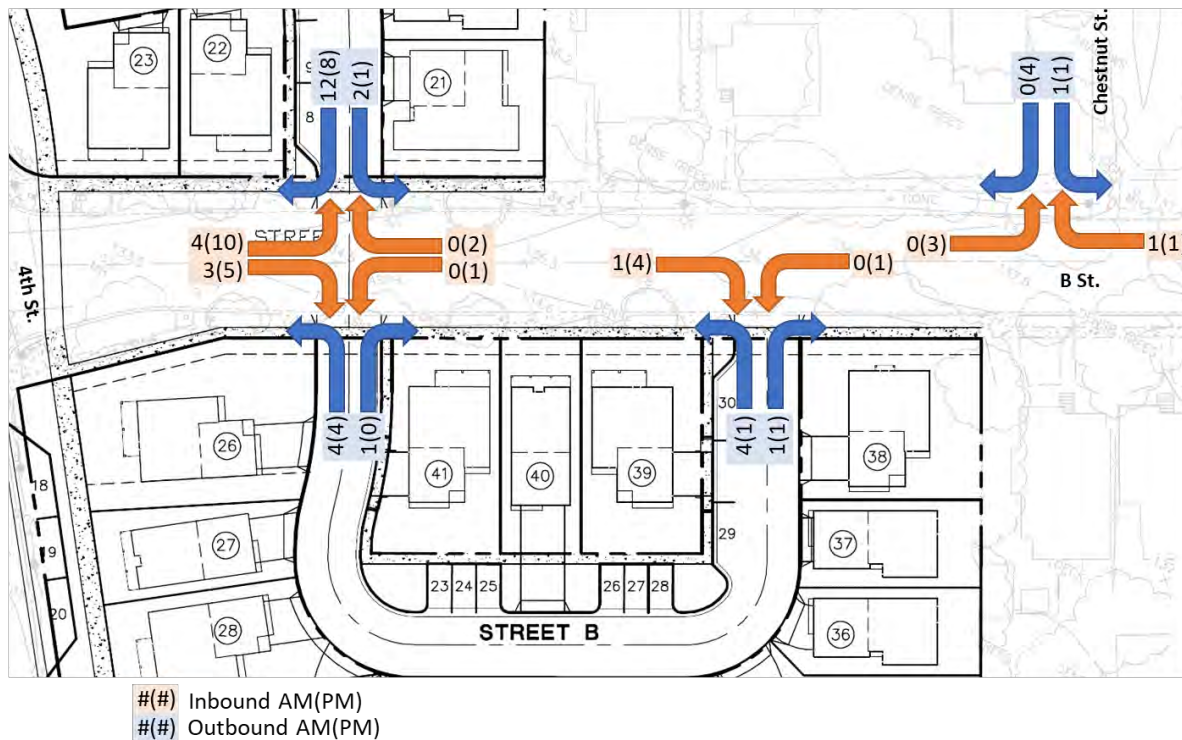

Source: Kittelson and Associates, Inc., 2018

Existing Plus Project Conditions

This section documents the results of the analysis during Existing Plus Project Conditions.

Existing Plus Project Traffic Volumes

The Project-only traffic volumes from Figure 5 were added to the Existing traffic volumes on Figure 3. The resulting Existing Plus Project traffic volumes, lane configurations, and intersection controls are shown on Figure 7. Lane configuration assumptions were the same as for the Existing conditions.

Figure 7 Existing Plus Project Traffic Volumes

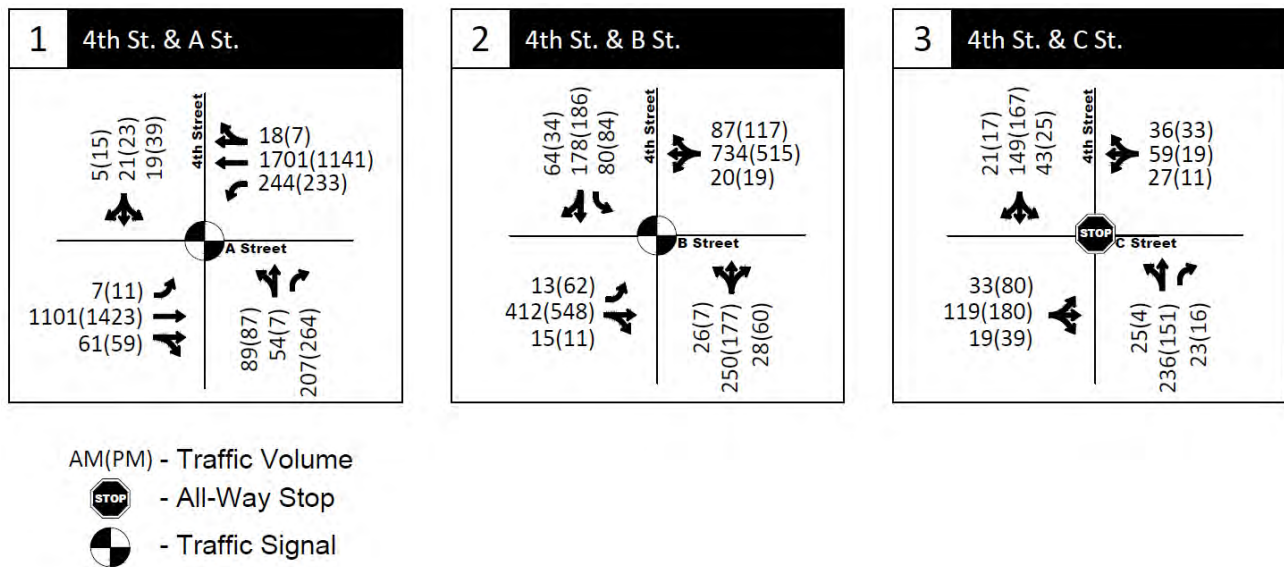

Source: Kittelson and Associates, Inc., 2018

Existing Plus Project Level of Service

Existing Plus Project LOS for the study intersections are shown in Table 6. As shown in the table, all intersections are forecast to operate acceptably (LOS E or better) in the AM and PM peak hours when accounting for Project trips. Given that all intersections operate acceptably in the Existing Plus Project scenario, the Project would not result in a significant impact. Average delay increases very slightly with the addition of project trips (0.2 to 0.5 seconds); this represents less than 4% increase.

Table 6 Level of Service – Existing Plus Project Conditions

Intersection	Traffic Control	Peak Hour	No Project		Plus Project		Change
			Delay	LOS	Delay	LOS	
1. 4 th Street & A Street	Signal	AM	19.5	B	19.7	B	+0.2
		PM	23.8	C	24.2	C	+0.4
2. 4th Street & B Street	Signal	AM	12.3	B	12.8	B	+0.5
		PM	8.9	A	9.2	A	+0.3
3. 4th Street & C Street	AWSC	AM	12.9	B	13.1	B	+0.2
		PM	11.6	B	11.8	B	+0.2

Bold indicates unacceptable LOS.

Shading indicates a significant impact

AWSC denotes All-Way Stop Control.

Source: Kittelson & Associates, Inc., 2018

The City has expressed interest in exploring a dedicated westbound left turn lane at 4th Street and B Street, which currently consists of a shared westbound left/through/right lane. The additional lane could be accommodated within the existing right-of-way. As shown in Table 7, the addition of a dedicated westbound left turn lane would not result in improved operations during either peak hour. Therefore, a westbound left turn lane is not recommended at this time. Please note, traffic calming measures recommended later in this memo may preclude adding a westbound left turn lane at a later time.

Table 7 Level of Service -- 4th Street & B Street with Westbound Left Turn Lane

Peak Hour	No Project		Plus Project		With WBL Lane	
	Delay	LOS	Delay	LOS	Delay	LOS
AM	12.3	B	12.8	B	13.2	B
PM	8.9	A	9.2	A	9.7	A

Bold indicates unacceptable LOS.

Source: Kittelson & Associates, Inc., 2018

Existing Plus Project Traffic Warrants

Traffic signal and pedestrian signal warrants for the intersection of 4th Street & C Street are shown in Table 8. As shown in the table, the Project does not trigger a traffic signal warrant or pedestrian signal warrant in either peak hour.

Table 8 Intersection Traffic Warrants – Existing Plus Project Conditions

Intersection	Traffic Control	Peak Hour	Traffic Signal Warrant	Pedestrian Signal Warrant
3. 4th Street & C Street	AWSC	AM	No	No
		PM	No	No

Bold indicates a triggered warrant.

AWSC denotes All-Way Stop Control.

Source: Kittelson & Associates, Inc., 2018

Existing Plus Project Queuing

The 95th percentile queue lengths (when accounting for Project trips) at the study intersections are shown in Table 9. As shown in the table, the Project would not cause queues lengths to exceed available storage at the study intersections. However, the AM and PM peak hour queues for westbound left turning vehicles at the intersection of 4th Street & A Street, which exceed the storage length in the Existing scenario, would each increase by one foot when including Project trips.

It should be noted that the painted median on A Street east of the intersection of 4th Street & A Street could potentially be restriped to provide additional vehicle storage for the westbound left turning lanes at this intersection. However, this roadway segment is outside the boundaries of the City of Hayward and is within Alameda County's unincorporated Castro Valley community.

Table 9 Queuing – Existing Plus Project Conditions

Intersection	Movement	Pocket Length	Peak Hour	No Project Queue	Plus Project Queue	Change
1. 4 th Street & A Street	Northbound Right	95'	AM	62'	63'	+1'
			PM	59'	60'	+1'
	Eastbound Left	70'	AM	<25'	<25'	0'
			PM	25'	25'	0'
Westbound Left	110'	AM	273'	274'	+1'	
		PM	212'	213'	+1'	
2. 4th Street & B Street	Southbound Left	105'	AM	63'	66'	+3'
			PM	56'	61'	+5'
	Eastbound Left	130'	AM	<25'	<25'	0'
			PM	28'	28'	0'
3. 4th Street & C Street	Northbound Right	35'	AM	<25'	<25'	0'
			PM	<25'	<25'	0'

Notes:

All queues are 95th percentile lengths and are presented in feet.

Bold indicates queue exceeding storage length.

Source: Kittelson & Associates, Inc., 2018

SITE ACCESS, CIRCULATION, AND MULTIMODAL ANALYSIS

This section documents access and circulation at the Project site and conditions for people driving, biking, walking, or taking transit to, from, or near the Project.

Vehicular Access

Vehicles accessing the Project site can utilize 4th Street and A Street, B Street, and C Street, which cross 4th Street in the study area. Near the Project site, 4th Street, B Street, and C Street provide one travel lane in each direction; A Street provides two travel lanes in each direction. Speed limits in the study area are as follows:

- 4th Street: 25 mph
- A Street: 35 mph
- B Street: 25 mph
- C Street: 25 mph

There are two access points for the Project's southern portion directly located on B Street. The western driveway is located approximately 130 feet east of 4th Street and the eastern driveway is located approximately 270 feet east of 4th Street. Both driveways are proposed to be full-access, unsignalized, and stop-controlled for vehicles exiting the driveways.

There are two access points for the Project's northern portion. The western driveway is located directly on B Street, approximately 120 feet east of 4th Street; this driveway will be full-access, unsignalized, and stop-controlled for vehicles exiting the driveway. An alternate access point for the northern portion is located on Chestnut Street, which runs north-south to the east of the project site. Vehicles traveling to and from this driveway would access the project through the intersection of B Street & Chestnut Street, which is a side-street stop-controlled intersection located approximately 410 feet east of 4th Street.

Vehicles using the Project driveways may conflict with westbound queues at the intersection of 4th Street & B Street, which provides a single shared westbound left-through-right lane. This is a potential issue for the following driveway movements:

- Left-turning or right-turning vehicles exiting the northern Project driveways onto B Street.
- Left-turning vehicles exiting the southern Project driveways onto B Street.
- Left-turning vehicles entering any of the Project driveways from B Street.

The 95th percentile westbound queue lengths at the intersection are shown in Table 10. As shown in the table, westbound queue lengths are forecast to exceed the distance between the intersection and the Project's southern driveways during both peak hours. The queue length is also forecast to exceed the

distance between the intersection and the Project's northwestern driveway during both peak hours; vehicles using the Chestnut Street northern driveway to access the northern portion may face excessive queues during the AM peak hour. In order to facilitate vehicles entering and exiting the Project driveways, the roadway striping along the Project's B Street frontage could be modified to display a prohibition against vehicles blocking access to the Project driveways (Keep Clear) when waiting at a red light. Recommended improvements also include installing cautionary signage warning of the new driveway locations on B Street approaching the Project.

As previously discussed, the City has expressed interest in exploring a dedicated westbound left turn lane at 4th Street & B Street, including its effects on the intersection's westbound queue. Table 10 shows westbound queues with the installation of a westbound left turn lane. The dedicated left turn lane results in relatively minor reductions in westbound queuing. Therefore, a westbound left turn lane is not recommended at this time. In addition, traffic calming measures recommended in this section may preclude adding a westbound left turn lane at a later time.

Table 10 Westbound Queuing -- 4th Street & B Street

Intersection	Movement	Peak Hour	No Project	Plus Project	With WBL Lane
2. 4th Street & B Street	Westbound Left/Through/Right	AM	510'	534'*	510'*
		PM	262'	274'	255'
	Westbound Left	AM	--	--	< 25'
		PM	--	--	< 25'

Notes:

With implementation of a dedicated westbound left turn lane, the left turn movement would not share a lane with the through and right turn movements.

All queues are 95th percentile lengths and are presented in feet.

Asterisk (*) denotes that 95th percentile volume exceeds capacity, queue may be longer.

Source: Kittelson & Associates, Inc., 2018

Vehicle Parking

The City of Hayward minimum off-street parking requirements for single-family dwellings are shown in Table 11. As shown in the table, the minimum parking requirements for newly-built dwelling units is dependent on whether a lot abuts a street that provides on-street parking. Given that the Project will provide on-street parking along 4th Street and internal roads in both the northern and southern portions, the Project is required to provide a minimum of two covered spaces per dwelling unit.

Table 11 City of Hayward Minimum Off-Street Parking Requirements – Single-Family Dwellings

Condition	Parking Spaces Required
Single-family dwelling	2.0 covered per dwelling unit
If a lot abuts a public or private street that has no parking lane on either side of the street or is posted for no parking on both sides of the street.	2.0 covered per dwelling unit plus 2.0 open per dwelling unit, which shall not block access to the covered parking
If a dwelling with a single car garage was built prior to March 24, 1959	1.0 covered per dwelling unit

Source: City of Hayward Municipal Code Sec. 10-2.310

The Project's parking supply for the northern and southern portions is shown in Table 11. As shown in the table, the Project provides the required two covered spaces per dwelling unit. In the northern portion, 50 garage spaces are provided for 25 dwelling units. In the southern portion, 32 garage spaces are provided for 16 dwelling units. In addition, the Project includes driveway spaces and on-street parking spaces as shown in Table 12.

Table 12 Project Parking Supply

Project Section	Dwelling Units	Garage Spaces	Private Driveway Spaces	On-Street Parking Spaces	Total Parking Spaces
North Site	25	50	20	17	87
South Site	16	32	10	13	55

Source: Dutra Enterprises, 2017

Bicycle Access

Existing bicycle volumes at the three study intersections along 4th Street are shown in Table 13. Low levels of bicycle activity were observed during the weekday AM peak hour. However, a significantly higher number of bicyclists passed through the intersections during the PM peak hour.

Table 13 Existing Bicycle Counts

Intersection	AM Peak Hour	PM Peak Hour
1. 4 th Street & A Street	3	16
2. 4 th Street & B Street	6	14
3. 4 th Street & C Street	1	10

Source: Kittelson & Associates, Inc., 2018

Currently, bicyclists accessing the Project site can utilize a Class III bike route along 4th Street and on A Street west of the Project. Bike route signage and shared lane markings (sharrows) are not currently

provided on 4th Street. In addition, bicycle lanes on A Street provide access between the Project and Castro Valley. The bicycle lanes start outside the City of Hayward limits, approximately 95 feet east of the intersection of 4th Street & A Street. These facilities are shown on Figure 8. Bicycle access points at the Project site include the driveways (along B Street and Chestnut Street) and the Project frontage along 4th Street and B Street. To facilitate bicycling to the Project and in the site vicinity, the Project sponsor should also examine opportunities with the City to install bike route signage and sharrows along 4th Street's bike route.

The Project driveways present a potential conflict between bicyclists and vehicles. Vehicles entering or exiting the Project driveways could potentially cross the path of a bicyclist traveling on B Street. The potential for conflict could be reduced by ensuring (with caution signage, stop bars, and marked crosswalks) that vehicles stop before exiting the driveways.

Figure 8 Existing Bicycle Facilities



- Class II Bike Lane
- Class III Bike Route

Source: Kittelson and Associates, Inc., 2018

Pedestrian Access

Existing pedestrian volumes at the three study intersections along 4th Street are shown in Table 14. Generally, pedestrian volumes are higher in the AM peak hour than in the PM peak hour. Also, no pedestrians were observed crossing any of the three intersections' eastern legs, which do not provide marked crosswalks, curb ramps, or pedestrian signal heads.

Table 14 Existing Pedestrian Counts

Intersection	Intersection Leg	AM Peak Hour	PM Peak Hour
1. 4 th Street & A Street	North Leg	9	1
	South Leg	0	5
	East Leg	0	0
	West Leg	7	4
2. 4 th Street & B Street	North Leg	7	3
	South Leg	6	14
	East Leg	0	0
	West Leg	12	2
3. 4 th Street & C Street	North Leg	11	1
	South Leg	5	5
	East Leg	2	1
	West Leg	11	6

Source: Kittelson & Associates, Inc., 2018

Currently, pedestrians accessing the Project site can utilize a sidewalk system in the study area shown on Figure 9. Sidewalks are provided along most roadways in the area; when present, sidewalks are generally in good condition and free of cracks. Several sidewalk gaps exist along 4th Street, including:

- Between A Street and B Street – Entire east side
- Between A Street and B Street – Portion of west side
- Between B Street and C Street – Upper half of west side
- Between B Street and C Street – Most of east side

The sidewalks provided on 4th Street between B Street and C Street do not have raised curbs; several vehicles were parked on these sidewalks during field observations.

Marked crosswalks in the area are also shown on Figure 9. As shown on the figure, the two signalized intersections of 4th Street & A Street and 4th Street & B Street do not provide crosswalks on their eastern legs; crossing these legs is prohibited with signage and neither curb ramps nor pedestrian signal heads are provided. Pedestrian countdown signals are available on three legs at 4th Street & B Street and on the southern leg at 4th Street & A Street. In addition, marked crosswalks are not provided on the northern and eastern legs of 4th Street & C Street.

To facilitate pedestrian access, the proposed Project includes the installation and improvement of sidewalks along the Project frontage, including filling in sidewalk gaps along 4th Street adjacent to the Project. Pedestrian access points to the Project include the sidewalk-adjacent frontage as well as the Project driveways.

The Project driveways present a potential conflict between pedestrians and vehicles which parallel potential issues between bicyclists and vehicles at the driveways. Vehicles entering or exiting the Project driveways could cross the path of a pedestrian crossing the driveway. Improvements such as caution signage, stop bars, and marked crosswalks at the driveways can help facilitate pedestrian travel and reduce the potential for conflicts with vehicles.

The Project sponsor should also examine opportunities with the City to install a marked crosswalk, pedestrian bulbouts, curb ramps, and a pedestrian countdown signal on the eastern leg of 4th Street & B Street. This would include expanding the traffic signal hardware to add a pedestrian phase, a pedestrian signal head, and a pedestrian push button. Currently, pedestrians that want to cross that leg must cross the intersection's three other legs or illegally cross, which presents a safety hazard. Installing facilities on the eastern leg would facilitate pedestrian travel between Project residents and local destinations; it would also improve transit access for residents, which will be discussed in the following section.

Figure 9 Existing Pedestrian Facilities

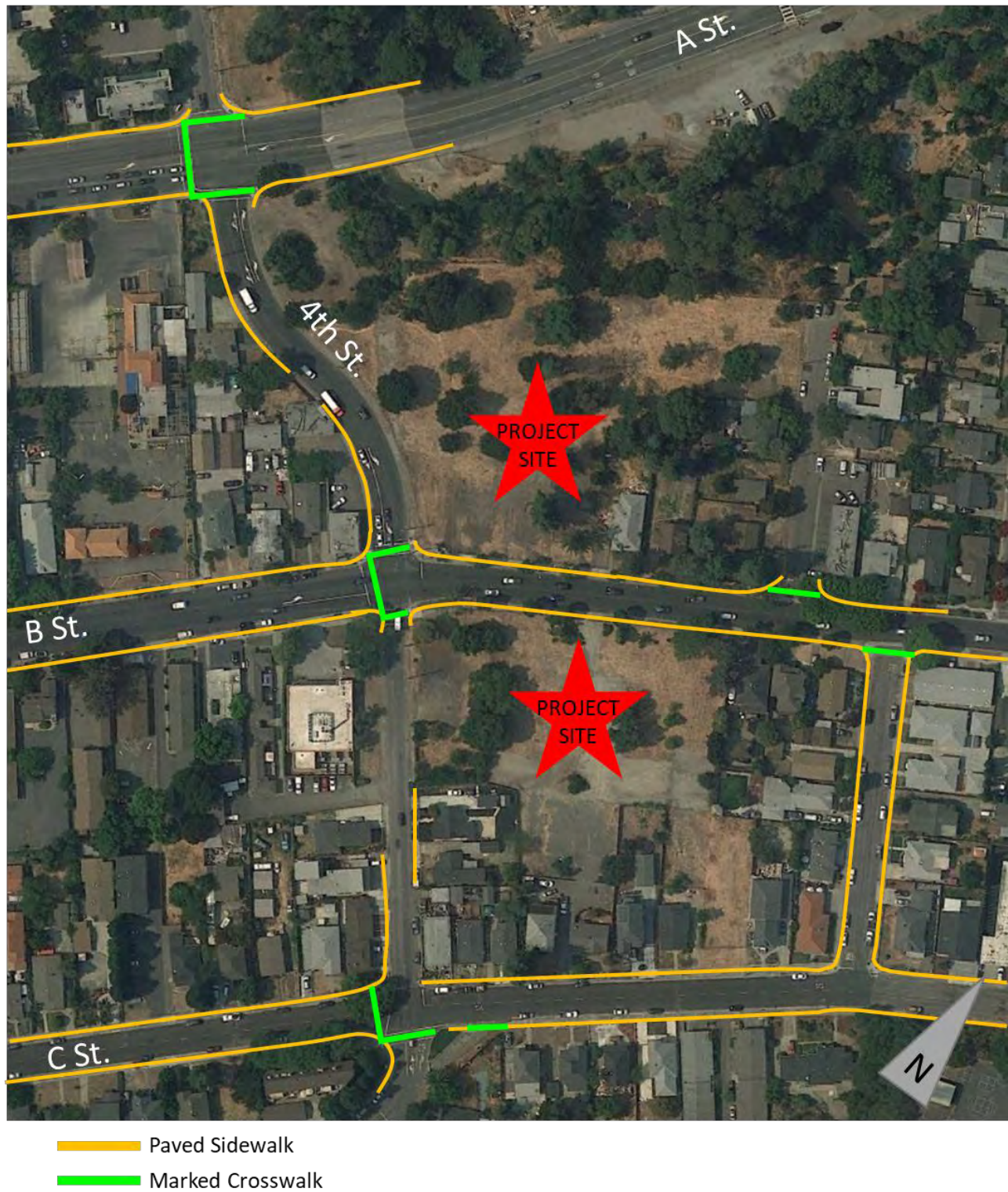

Source: Kittelson and Associates, Inc., 2018

Transit Access

Transit service near the Project site is shown on Figure 10. Bus service on B Street consists of AC Transit Route 32, which connects to the Hayward BART Station to the west and other destinations such as Bay Fair BART and Castro Valley BART. AC Route 32 runs seven days a week with 60-minute headways. As part of its AC Go project, AC Transit will renumber this route to Route 28 and double weekday service to 30-minute headways; implementation is slated for June 2018.

There are four AC Route 32 bus stops in the Project vicinity, listed below and shown on Figure 10. All four of these stops consist of a simple pole and sign; none offer amenities such as a bench or shelter. Given the close bus stop spacing near the Project (440 feet for the westbound stops and 645 feet for the eastbound stops) a sufficient number of bus stops are provided in the study area.

- Stop #51534 located at the northwest corner of 4th Street & B Street, directly to the west of the Project.
- Stop #59878 located at the southeast corner of 4th Street & B Street, directly between the Project's northern and southern portions.
- Stop #58230 located at the southwest corner of 5th Street & B Street, directly to the east of the Project.
- Stop #58920 located at the northeast corner of 5th Street & B Street, directly to the east of the Project.

Pedestrian movement between the Project and these stops consists of sidewalks along both sides of B Street. However, Project residents wishing to walk between the Project's northern portion and the eastbound Route 32 bus stop closest to the Project (stop #59878 at the southeast corner of 4th Street & B Street) must cross three intersection legs or unsafely cross B Street since the intersection does not provide a crosswalk, curb ramps, or pedestrian signal head on its eastern leg. As previously stated, the Project sponsor should examine opportunities with the City to install a marked crosswalk, pedestrian bulbouts, curb ramps, and a pedestrian countdown signal on the eastern leg of 4th Street and B Street.

The location of stop #59878 at the southeast corner of 4th Street & B Street relative to the Project's southwestern driveway presents a potential conflict between transit vehicles, transit users, and automobiles entering the Project's southern portion. Given the bus stop's location directly to the left of the driveway, eastbound vehicles making a right turn from B Street into the driveway may not see pedestrians crossing the driveway to and from a stopped bus. However, relocating this bus stop to the intersection's near side is not recommended; far side stop placement is optimal for bus operations. Based on transit facility recommendations outlined in AC Transit's *Designing with Transit* (2004), which discourages improvements such as bus bays (which require a bus to reenter vehicle traffic), improvements at this location can include a bus bulbout. This improvement can be complemented with signage warning vehicles of pedestrians crossing the driveway to and from the bus stop. Please note, a bus bulbout at this location would be recommended in place of a southern pedestrian bulbout and would require an eastbound white line extension through the intersection.

Figure 10 Existing Transit Facilities



Source: Kittelson and Associates, Inc., 2018

TRAFFIC CALMING

The City of Hayward has expressed concerns regarding high traffic volumes on 4th Street and on B Street due to vehicles diverting or passing through to other facilities or destinations. Pass-through vehicle concerns can be addressed with traffic calming measures to slow vehicles down to safer speeds. Examples of traffic calming measures can include:

- Narrowing roadways
 - Adding on-street parking
 - Installing a bike lane
 - Adding curb extensions and bulbouts
 - Adding bollards and planters
 - Removing lanes
- Vertical deflection such as speed bumps, humps, or tables
- Horizontal deflection
 - Lateral shift with a median island and curb extensions
 - Lateral shift with a chicane and curb extensions
- Enforcement and education
 - Speed cameras
 - Vehicle activated speed signs
- Lowering speed limits

Existing peak hour traffic volumes on 4th Street and B Street adjacent to the Project site are shown in Table 15. As shown in the table, B Street experiences significant vehicle volumes in both peak hours despite being a two-lane undivided roadway. Based on these traffic volumes, B Street can benefit from traffic calming measures.

Table 15 Roadway Segment Volumes

Roadway Segment	AM Peak Hour	PM Peak Hour
4 th Street (A Street to B Street)	662	649
B Street (4 th Street to Chestnut Street)	1,333	1,308

Source: Kittelson & Associates, Inc., 2018

As previously discussed, the Project sponsor should examine opportunities with the City to install a marked crosswalk, northern pedestrian bulbout, curb ramps, and a pedestrian countdown signal on the eastern leg of 4th Street & B Street, and a southern bus bulbout along the Project frontage. While these can serve as traffic calming measures to slow vehicles down, the Project sponsor and the City can explore additional options on B Street adjacent to the Project site, including:

- Given B Street's wide cross section adjacent to the project site (approximately 40 feet across with two travel lanes and no on-street parking), the lanes on this segment can be narrowed to reduce vehicle speeds. This can be achieved with shoulder striping to reduce lane widths.

- The wide cross-section on this segment can be utilized to install bicycle lanes, which would reduce lane widths and also address the lack of bicycle facilities on B Street and connect Project bicyclists to the bike route on 4th Street. However, this measure's effectiveness in improving bicycle accessibility could be limited given that it does not connect to bicycle lanes along other B Street segments. However, the City of Hayward is in the process of updating its active transportation plan; bicycle lanes on this segment can be incorporated into a larger future bikeway network. Furthermore, if the City and Project sponsor choose to add shoulder striping to reduce lane widths (as discussed above), the right-of-way can be reallocated to bicycle lanes at a later time if right-of-way permits.
- A midblock pedestrian crosswalk can be installed on B Street between 4th Street and Chestnut Street. This measure can serve both as a traffic calming technique and improve pedestrian connectivity between the Project's northern and southern portions.
- Lateral shifts, whether through the installation of a median and curb extensions or chicanes, realigns an otherwise straight street to reduce vehicle speeds. However, lateral shifts are not recommended based on guidance provided in AC Transit's *Designing with Transit*, which discourages these treatments along streets with bus service.

There are also opportunities for traffic calming on Chestnut Street, which is located directly to the east of the Project and provides vehicle access to the northern portions' eastern driveway. Given that this street also includes other residences with several driveways and few pedestrian facilities, potential measures on this street can include installing speed limit signs and street markings.

Despite its lower traffic volumes, 4th Street adjacent to the Project can also benefit from traffic calming measures. As previously discussed, the Project includes sidewalks on its 4th Street frontage and recommended improvements on this segment include signage and sharrows for the Class III bike route. However, the Project sponsor and the City can examine opportunities to install bicycle lanes or narrow automobile lanes on this street.

Conceptual traffic calming treatments are shown on Figure 11.

Figure 11 Proposed Improvements

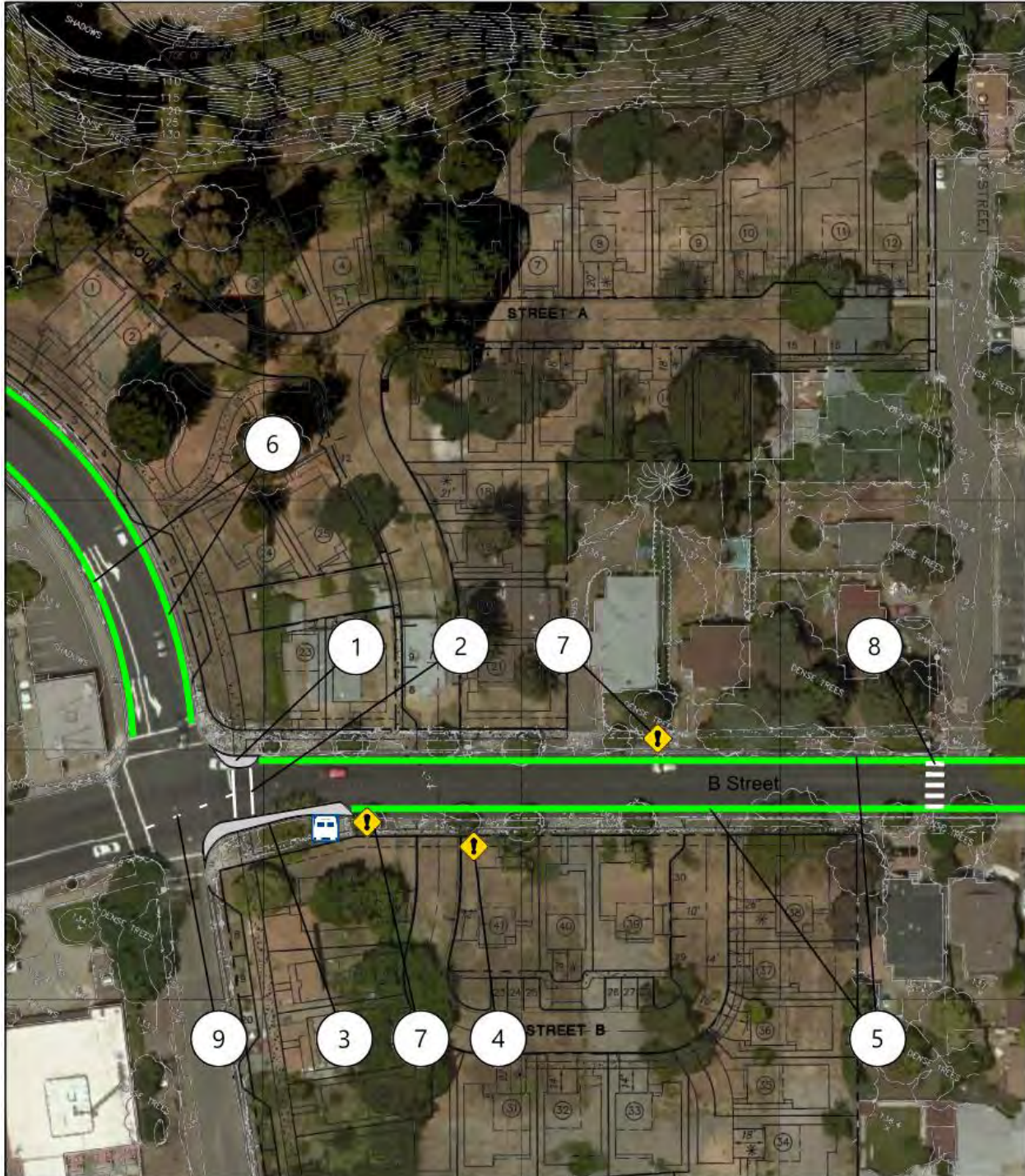

1. Install Pedestrian Bulbout
2. Install Crosswalk
3. Install Bus Bulbout
4. Install Pedestrian Caution Signage for Entering Vehicles
5. Install Bike Lanes (if Right-of-Way Available) or Narrow Auto Lanes
6. Install Bike Lanes (if Right-of-Way Available)
7. Install Driveways Ahead Signage
8. Install Midblock Crosswalk and Pedestrian Crossing Signage
9. Install Eastbound White Line Extension Through Intersection

Note: The designs presented in this exhibit are conceptual

Source: Kittelson and Associates, Inc., 2018

SUMMARY AND CONCLUSIONS

The Project sponsor is proposing to build 41 single-family housing units at the corner of 4th Street & B Street in Hayward, CA. The anticipated trip generation is 458 daily trips, 34 trips during the AM peak hour (9 inbound and 25 outbound) and 43 trips in the PM peak hour (27 inbound and 16 outbound). The findings documented in this memorandum are as follows:

- The Project will not result in a significant impact at the intersections of 4th Street & A Street, 4th Street & B Street, and 4th Street & C Street. All intersections operate at an acceptable LOS in the AM and PM peak hours.
- The Project will not trigger a traffic signal warrant or a pedestrian signal warrant at the intersection of 4th Street & C Street.
- The Project will not significantly increase queues or cause queue lengths to exceed turn pocket lengths at the study intersections. However, the westbound left turn queue at 4th Street & A Street exceeds the turn pocket length in both Existing and Existing Plus Project conditions.
- Westbound queues at the intersection of 4th Street & B Street may block access to and from the Project driveways on B Street. This can be addressed with roadway markings or signage prohibiting vehicles waiting at the intersection from blocking the driveways.
- The addition of a westbound left turn lane at the intersection of 4th Street and B Street would not result in significantly improved LOS or westbound queuing and is not recommended at this time.
- The Project driveways are potential conflict points for vehicles, bicyclists, pedestrians, and transit users which can be addressed with treatments.
- The Project sponsor should explore working with the City to install bike route signage and sharrows or bike lanes along 4th Street to improve bicycling conditions in the study area.
- The Project sponsor should explore working with the City to install a crosswalk, curb ramps, a pedestrian signal, and a pedestrian bulbout on the eastern leg of the 4th Street & B Street intersection to improve pedestrian mobility and access to transit.
- The Project sponsor should work with the City and AC Transit to explore installing a bus bulbout at the bus stop along the Project's B Street frontage (at the southeastern quadrant of 4th Street and B Street).
- B Street can benefit from traffic calming measures to reduce vehicle speeds; potential options include shoulder striping to narrow vehicle lanes, bicycle lanes, and a midblock pedestrian crosswalk.
- Chestnut Street can benefit from traffic calming measures such as speed limit signs and street markings.

Attachments:

- A. Traffic Counts**
- B. Existing Conditions Synchro Output Sheets**
- C. Existing Plus Project Conditions Synchro Output Sheets**
- D. Intersection Signal Warrant Sheets (4th Street & C Street)**
- E. 4th Street & B Street Westbound Left Turn Synchro Output Sheets**
- F. Signal Timing Sheets**

Attachment A: Traffic Counts

Type of peak hour being reported: Intersection Peak

Method for determining peak hour: Total Entering Volume

LOCATION: 4th St -- A St
CITY/STATE: Hayward, CA

QC JOB #: 14606101
DATE: Tue, Jan 23 2018

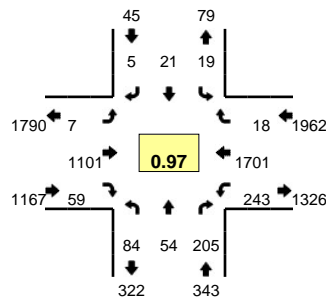

Peak-Hour: 7:40 AM -- 8:40 AM
Peak 15-Min: 8:00 AM -- 8:15 AM

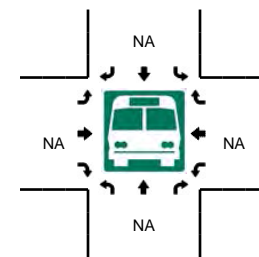
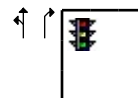
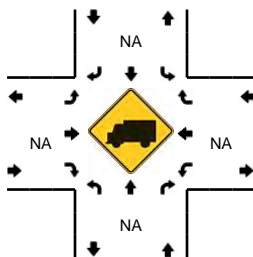
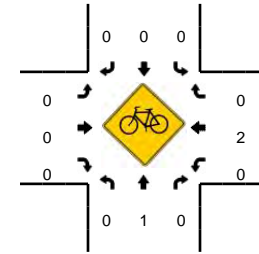
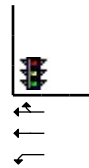
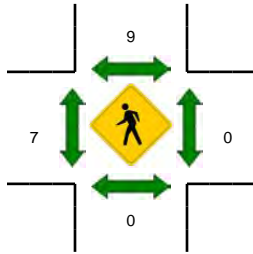
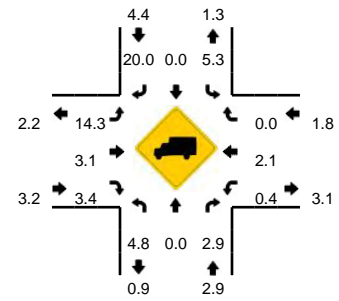

5-Min Count Period Beginning At	4th St (Northbound)				4th St (Southbound)				A St (Eastbound)				A St (Westbound)				Total	Hourly Totals
	Left	Thru	Right	U	Left	Thru	Right	U	Left	Thru	Right	U	Left	Thru	Right	U		
7:00 AM	4	1	13	0	0	0	0	0	0	41	2	0	6	98	0	0	165	
7:05 AM	4	2	13	0	0	0	0	0	0	33	2	0	7	93	0	1	155	
7:10 AM	7	1	13	0	0	0	0	0	0	48	0	0	13	126	3	0	211	
7:15 AM	1	0	24	0	0	0	1	0	0	69	0	0	9	108	1	0	213	
7:20 AM	6	2	20	0	0	1	0	0	0	63	1	0	13	111	1	0	218	
7:25 AM	4	1	20	0	0	1	0	0	0	88	1	0	7	133	2	0	257	
7:30 AM	12	1	16	0	0	1	0	0	0	68	2	0	11	106	0	0	217	
7:35 AM	2	4	8	0	1	0	0	0	0	105	2	0	7	135	0	0	264	
7:40 AM	4	0	18	0	1	0	0	0	0	103	0	0	17	179	0	0	322	
7:45 AM	8	3	21	0	1	3	1	0	0	82	6	0	23	143	3	0	294	
7:50 AM	9	2	15	0	1	2	1	0	0	97	2	0	18	142	0	0	289	
7:55 AM	4	4	15	0	1	1	0	0	0	90	5	0	17	138	3	1	279	2884
8:00 AM	4	4	14	0	4	3	0	0	0	121	6	0	26	150	2	0	334	3053
8:05 AM	8	4	16	0	3	4	0	0	0	102	5	0	22	117	2	0	283	3181
8:10 AM	8	3	20	0	0	3	0	0	0	87	14	0	20	135	1	0	291	3261
8:15 AM	8	7	18	0	2	2	0	0	0	90	8	0	19	138	1	0	293	3341
8:20 AM	8	3	20	0	2	2	0	0	1	98	3	0	10	151	3	0	301	3424
8:25 AM	9	5	19	0	0	0	0	0	2	83	5	0	24	144	0	0	291	3458
8:30 AM	10	14	18	0	2	1	2	0	2	71	3	0	29	123	0	0	275	3516
8:35 AM	4	5	11	0	2	0	1	0	2	77	2	0	17	141	3	0	265	3517
8:40 AM	4	2	10	0	0	0	0	0	1	79	2	0	11	146	0	0	255	3450
8:45 AM	6	5	8	0	0	1	0	0	1	66	3	0	7	132	0	0	229	3385
8:50 AM	4	1	7	0	0	0	0	0	0	56	0	0	10	114	0	0	192	3288
8:55 AM	1	1	11	0	1	1	0	0	1	57	2	0	8	125	2	0	210	3219
Peak 15-Min Flowrates	Northbound				Southbound				Eastbound				Westbound				Total	
	Left	Thru	Right	U	Left	Thru	Right	U	Left	Thru	Right	U	Left	Thru	Right	U		
All Vehicles	80	44	200	0	28	40	0	0	0	1240	100	0	272	1608	20	0	3632	
Heavy Trucks	0	0	12		4	0	0		0	28	0		4	32	0		80	
Pedestrians		0				0				4				0			4	
Bicycles	0	0	0		0	0	0		0	0	0		0	0	0		0	
Railroad																		
Stopped Buses																		

Comments:

Type of peak hour being reported: Intersection Peak

Method for determining peak hour: Total Entering Volume

LOCATION: 4th St -- A St
CITY/STATE: Hayward, CA

QC JOB #: 14606102
DATE: Tue, Jan 23 2018

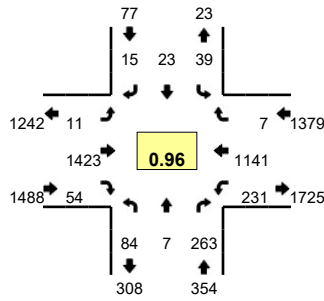

Peak-Hour: 4:55 PM -- 5:55 PM
Peak 15-Min: 5:20 PM -- 5:35 PM

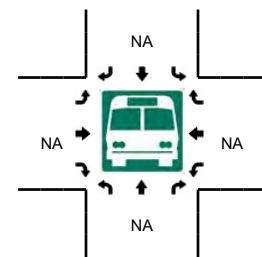
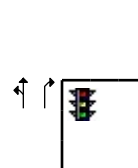
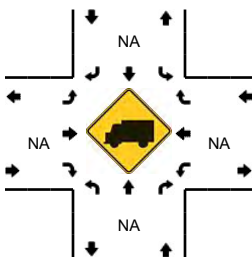
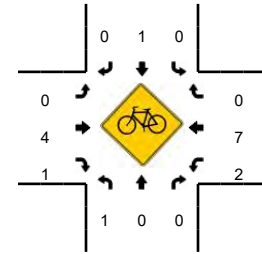
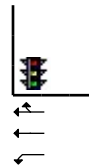
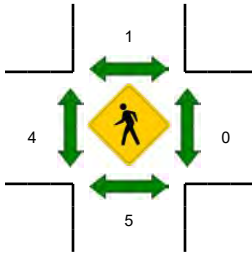
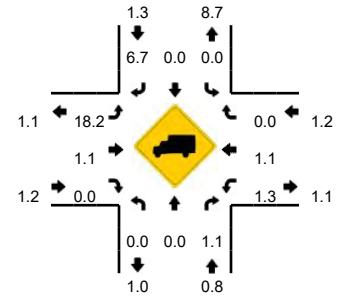

5-Min Count Period Beginning At	4th St (Northbound)				4th St (Southbound)				A St (Eastbound)				A St (Westbound)				Total	Hourly Totals
	Left	Thru	Right	U	Left	Thru	Right	U	Left	Thru	Right	U	Left	Thru	Right	U		
4:00 PM	11	1	24	0	2	0	0	0	0	88	4	0	22	63	0	0	215	
4:05 PM	3	0	12	0	1	3	0	0	1	123	6	0	16	81	1	0	247	
4:10 PM	6	1	16	0	1	1	0	0	0	101	6	0	18	87	1	0	238	
4:15 PM	10	1	17	0	5	3	0	0	0	108	11	1	19	78	1	0	254	
4:20 PM	12	4	23	0	1	5	0	0	1	129	7	0	20	78	0	0	280	
4:25 PM	10	3	22	0	0	0	1	0	1	109	7	1	17	76	1	0	248	
4:30 PM	13	2	26	0	0	4	0	0	1	121	4	0	18	91	1	0	281	
4:35 PM	2	0	20	0	3	1	1	0	1	89	6	0	20	75	4	0	222	
4:40 PM	3	1	13	0	3	2	0	0	1	103	3	1	15	98	0	0	243	
4:45 PM	2	4	22	0	1	1	0	0	0	93	5	0	25	63	0	0	216	
4:50 PM	3	1	20	0	1	0	1	0	0	112	0	0	12	74	0	0	224	
4:55 PM	10	1	25	0	1	4	2	0	0	112	4	0	16	99	0	0	274	2942
5:00 PM	4	1	30	0	2	0	4	0	2	112	3	0	8	83	0	0	249	2976
5:05 PM	13	1	25	0	4	1	1	0	0	130	6	1	22	73	1	0	278	3007
5:10 PM	11	1	20	0	4	1	0	0	0	122	4	1	24	104	1	0	293	3062
5:15 PM	4	0	16	0	1	2	1	0	1	120	12	0	21	99	0	0	277	3085
5:20 PM	9	1	18	0	5	1	1	0	1	96	2	0	21	115	1	0	271	3076
5:25 PM	5	0	23	0	4	5	2	0	2	131	3	0	22	99	1	0	297	3125
5:30 PM	4	0	24	0	3	0	2	0	0	146	4	0	15	96	0	0	294	3138
5:35 PM	7	0	26	0	3	3	1	0	0	106	3	0	19	80	2	0	250	3166
5:40 PM	5	0	21	0	4	3	0	0	2	122	6	0	21	125	1	0	310	3233
5:45 PM	6	1	19	0	3	2	1	0	1	99	4	0	23	91	0	0	250	3267
5:50 PM	6	1	16	0	5	1	0	0	0	127	3	0	19	77	0	0	255	3298
5:55 PM	4	0	13	0	1	1	0	0	1	115	7	0	15	102	0	0	259	3283
Peak 15-Min Flowrates	Northbound				Southbound				Eastbound				Westbound				Total	
	Left	Thru	Right	U	Left	Thru	Right	U	Left	Thru	Right	U	Left	Thru	Right	U		
All Vehicles	72	4	260	0	48	24	20	0	12	1492	36	0	232	1240	8	0	3448	
Heavy Trucks	0	0	4		0	0	0		4	16	0		0	12	0		36	
Pedestrians	0				4				8				0				12	
Bicycles	0	0	0		0	1	0		0	1	0		0	2	0		4	
Railroad																		
Stopped Buses																		

Comments:

Type of peak hour being reported: Intersection Peak

Method for determining peak hour: Total Entering Volume

LOCATION: 4th St -- B St
CITY/STATE: Hayward, CA

QC JOB #: 14606103
DATE: Tue, Jan 23 2018

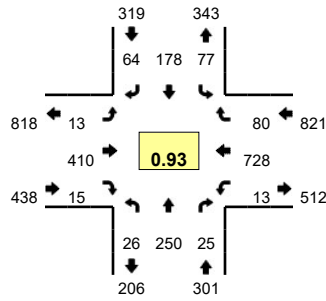

Peak-Hour: 7:40 AM -- 8:40 AM
Peak 15-Min: 8:20 AM -- 8:35 AM

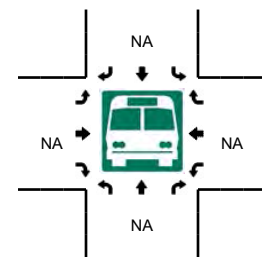
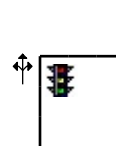
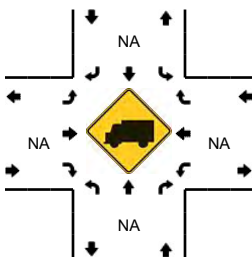
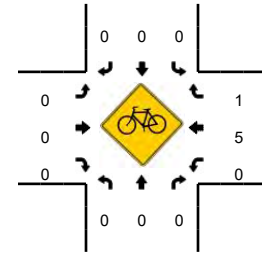
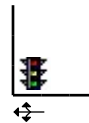
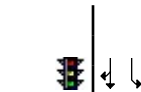
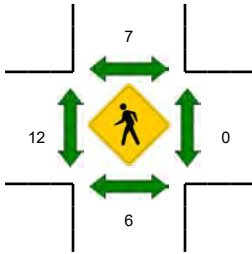
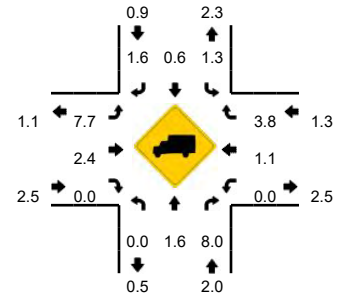

5-Min Count Period Beginning At	4th St (Northbound)				4th St (Southbound)				B St (Eastbound)				B St (Westbound)				Total	Hourly Totals
	Left	Thru	Right	U	Left	Thru	Right	U	Left	Thru	Right	U	Left	Thru	Right	U		
7:00 AM	0	14	1	0	5	5	0	0	0	13	1	0	0	52	5	0	96	
7:05 AM	1	10	0	0	2	5	2	0	0	20	2	0	0	58	8	0	108	
7:10 AM	0	12	0	0	2	7	1	0	1	17	0	0	2	49	8	0	99	
7:15 AM	1	20	1	0	0	6	1	0	0	19	0	0	1	61	6	0	116	
7:20 AM	0	14	1	0	2	9	4	0	0	30	0	0	0	51	9	0	120	
7:25 AM	0	21	1	0	0	13	1	0	3	24	0	0	1	59	4	0	127	
7:30 AM	2	16	1	0	5	6	1	0	1	24	1	0	1	64	13	0	135	
7:35 AM	2	11	1	0	4	7	1	0	1	25	1	0	4	51	4	0	112	
7:40 AM	1	18	1	0	1	12	4	0	1	22	0	0	0	56	5	0	121	
7:45 AM	1	20	0	0	3	14	3	0	0	30	0	0	2	70	7	0	150	
7:50 AM	1	21	3	0	4	19	3	0	0	33	1	0	0	63	5	0	153	
7:55 AM	2	18	3	0	7	15	3	0	2	41	0	0	1	62	5	0	159	1496
8:00 AM	0	24	0	0	9	24	4	0	1	37	1	0	3	59	7	0	169	1569
8:05 AM	3	14	2	0	6	15	2	0	0	43	0	0	0	55	5	0	145	1606
8:10 AM	4	23	1	0	14	19	6	0	1	26	2	0	1	41	10	0	148	1655
8:15 AM	3	27	1	0	6	14	7	0	2	37	3	0	0	64	9	0	173	1712
8:20 AM	3	23	5	0	6	8	6	0	2	36	1	0	1	60	5	0	156	1748
8:25 AM	3	25	3	0	11	9	9	0	0	41	5	0	0	63	5	0	174	1795
8:30 AM	4	25	2	0	7	13	11	0	3	33	2	0	1	65	10	0	176	1836
8:35 AM	1	12	4	0	3	16	6	0	1	31	0	0	4	70	7	0	155	1879
8:40 AM	1	7	1	0	4	8	0	0	2	27	0	0	4	53	6	0	113	1871
8:45 AM	1	9	3	0	2	5	3	0	1	32	0	0	2	58	10	0	126	1847
8:50 AM	2	10	0	0	1	6	5	0	0	34	0	0	1	52	3	0	114	1808
8:55 AM	0	9	1	0	5	1	2	0	0	44	0	0	0	62	2	0	126	1775
Peak 15-Min Flowrates	Northbound				Southbound				Eastbound				Westbound				Total	
All Vehicles	40	292	40	0	96	120	104	0	20	440	32	0	8	752	80	0	2024	
Heavy Trucks	0	0	0	0	4	0	0	0	4	12	0	0	0	8	4	0	32	
Pedestrians		8				12				4				0			24	
Bicycles	0	0	0	0	0	0	0	0	0	0	0	0	0	0	1	0	1	
Railroad																		
Stopped Buses																		

Comments:

Type of peak hour being reported: Intersection Peak

Method for determining peak hour: Total Entering Volume

LOCATION: 4th St -- B St
CITY/STATE: Hayward, CA

QC JOB #: 14606104
DATE: Tue, Jan 23 2018

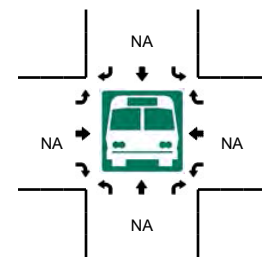
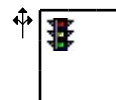
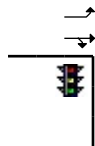
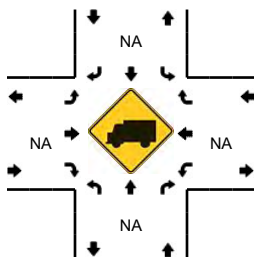
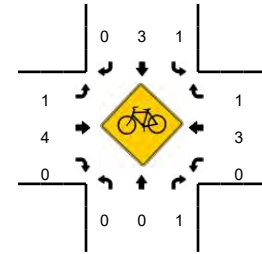
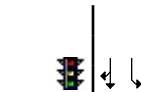
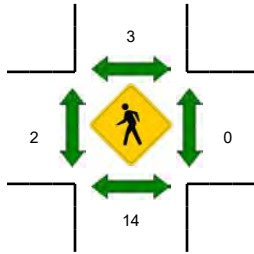
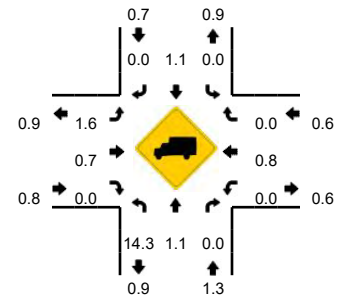
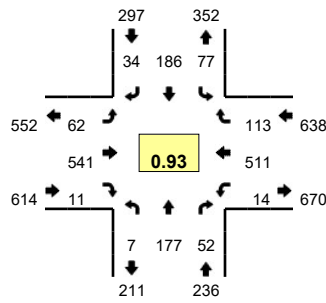

5-Min Count Period Beginning At	4th St (Northbound)				4th St (Southbound)				B St (Eastbound)				B St (Westbound)				Total	Hourly Totals
	Left	Thru	Right	U	Left	Thru	Right	U	Left	Thru	Right	U	Left	Thru	Right	U		
4:00 PM	2	25	5	0	8	9	2	0	6	48	1	0	3	35	6	0	150	
4:05 PM	0	10	6	0	11	17	5	0	2	42	1	0	0	13	4	0	111	
4:10 PM	0	10	3	0	5	16	2	0	7	42	1	0	0	36	8	0	130	
4:15 PM	1	14	2	0	9	21	4	0	6	47	4	0	3	29	7	0	147	
4:20 PM	1	22	4	0	12	16	3	0	4	52	2	0	0	38	13	0	167	
4:25 PM	3	22	3	0	12	13	4	0	2	52	1	0	0	30	12	0	154	
4:30 PM	0	30	2	0	7	15	4	0	2	44	1	0	1	45	8	0	159	
4:35 PM	1	15	4	0	1	20	1	0	3	42	0	0	0	36	5	0	128	
4:40 PM	0	8	4	0	5	13	2	0	3	47	3	0	1	43	4	0	133	
4:45 PM	0	18	3	0	7	18	1	0	7	39	0	0	1	34	5	0	133	
4:50 PM	0	17	5	0	5	8	4	0	4	57	0	0	2	28	9	0	139	
4:55 PM	1	15	3	0	9	13	2	0	6	45	1	0	0	37	10	0	142	1693
5:00 PM	1	20	5	0	3	5	2	0	5	49	1	0	1	31	8	0	131	1674
5:05 PM	0	16	5	0	7	14	1	0	6	50	1	0	1	41	17	0	159	1722
5:10 PM	0	13	3	0	9	19	0	0	8	39	1	0	1	45	16	0	154	1746
5:15 PM	1	6	1	0	11	21	7	0	4	50	0	0	0	49	8	0	158	1757
5:20 PM	1	20	4	0	8	15	0	0	0	44	0	0	1	42	8	0	143	1733
5:25 PM	0	12	4	0	3	19	4	0	6	38	2	0	1	37	9	0	135	1714
5:30 PM	1	14	9	0	3	20	2	0	6	53	1	0	1	49	5	0	164	1719
5:35 PM	1	18	7	0	5	11	4	0	6	39	1	0	2	58	11	0	163	1754
5:40 PM	1	13	4	0	5	17	5	0	6	37	2	0	3	55	5	0	153	1774
5:45 PM	0	13	2	0	9	24	3	0	5	40	1	0	1	39	7	0	144	1785
5:50 PM	2	9	4	0	4	12	2	0	5	51	1	0	1	36	11	0	138	1784
5:55 PM	0	10	0	0	10	12	1	0	2	51	1	0	0	36	7	0	130	1772
Peak 15-Min Flowrates	Northbound				Southbound				Eastbound				Westbound				Total	
	Left	Thru	Right	U	Left	Thru	Right	U	Left	Thru	Right	U	Left	Thru	Right	U		
All Vehicles	12	180	80	0	52	192	44	0	72	516	16	0	24	648	84	0	1920	
Heavy Trucks	0	4	0	0	0	0	0	0	0	4	0	0	0	0	0	0	8	
Pedestrians		16				0				4				0			20	
Bicycles	0	0	0		0	1	0		1	1	0		0	1	1		5	
Railroad																		
Stopped Buses																		

Comments:

Type of peak hour being reported: Intersection Peak

Method for determining peak hour: Total Entering Volume

LOCATION: 4th St -- C St
CITY/STATE: Hayward, CA

QC JOB #: 14606105
DATE: Tue, Jan 23 2018

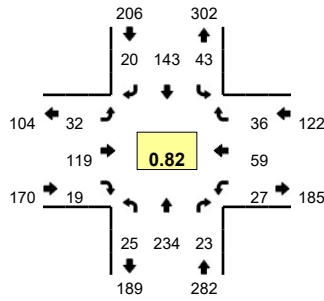

Peak-Hour: 7:40 AM -- 8:40 AM
Peak 15-Min: 8:10 AM -- 8:25 AM

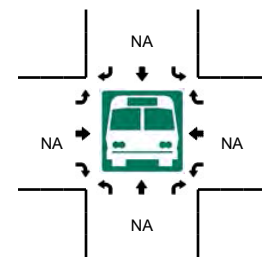
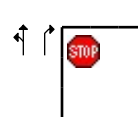
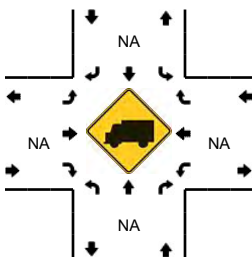
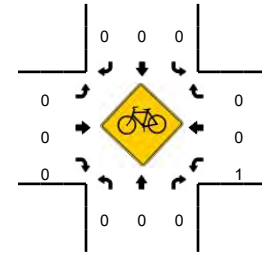
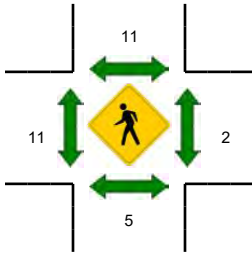
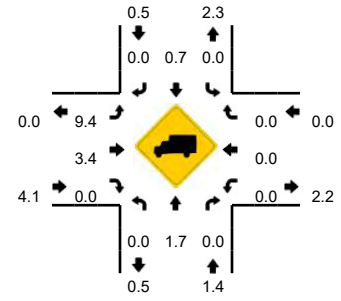

5-Min Count Period Beginning At	4th St (Northbound)				4th St (Southbound)				C St (Eastbound)				C St (Westbound)				Total	Hourly Totals
	Left	Thru	Right	U	Left	Thru	Right	U	Left	Thru	Right	U	Left	Thru	Right	U		
7:00 AM	0	11	0	0	1	6	0	0	1	2	0	0	2	2	3	0	28	
7:05 AM	0	7	1	0	2	4	0	0	2	5	1	0	2	4	1	0	29	
7:10 AM	1	11	0	0	0	9	1	0	1	4	1	0	0	1	2	0	31	
7:15 AM	0	17	1	0	1	7	0	0	2	3	0	0	1	2	3	0	37	
7:20 AM	1	11	1	0	0	9	1	0	2	4	1	0	2	4	1	0	37	
7:25 AM	0	21	2	0	0	13	0	0	3	4	0	0	1	2	2	0	48	
7:30 AM	0	8	1	0	1	7	0	0	0	8	1	0	3	5	3	0	37	
7:35 AM	1	11	2	0	1	8	2	0	2	5	0	0	4	0	2	0	38	
7:40 AM	3	17	1	0	0	8	2	0	1	4	5	0	4	3	1	0	49	
7:45 AM	2	19	2	0	2	12	3	0	5	6	0	0	1	6	0	0	58	
7:50 AM	2	18	3	0	2	16	0	0	1	5	0	0	1	3	3	0	54	
7:55 AM	0	18	3	0	1	13	0	0	1	12	2	0	3	3	5	0	61	507
8:00 AM	2	20	1	0	7	18	2	0	2	11	1	0	1	2	0	0	67	546
8:05 AM	6	11	3	0	1	12	2	0	3	13	3	0	2	4	4	0	64	581
8:10 AM	4	28	2	0	6	18	1	0	0	11	0	0	1	5	5	0	81	631
8:15 AM	1	23	2	0	8	10	1	0	3	21	4	0	3	4	4	0	84	678
8:20 AM	2	27	1	0	2	6	1	0	7	12	2	0	1	7	4	0	72	713
8:25 AM	2	25	2	0	5	6	2	0	1	11	1	0	4	7	2	0	68	733
8:30 AM	0	17	3	0	3	10	3	0	6	6	1	0	3	8	6	0	66	762
8:35 AM	1	11	0	0	6	14	3	0	2	7	0	0	3	7	2	0	56	780
8:40 AM	0	8	0	0	0	10	2	0	0	6	1	0	3	6	1	0	37	768
8:45 AM	1	12	1	0	0	6	1	0	3	1	1	0	0	0	1	0	27	737
8:50 AM	1	4	1	0	0	5	2	0	1	4	0	0	1	0	3	0	22	705
8:55 AM	2	10	0	0	0	1	0	0	2	2	0	0	3	3	1	0	24	668
Peak 15-Min Flowrates	Northbound				Southbound				Eastbound				Westbound				Total	
	Left	Thru	Right	U	Left	Thru	Right	U	Left	Thru	Right	U	Left	Thru	Right	U		
All Vehicles	28	312	20	0	64	136	12	0	40	176	24	0	20	64	52	0	948	
Heavy Trucks	0	8	0	0	0	4	0	0	0	0	0	0	0	0	0	0	12	
Pedestrians	0	0	0	0	0	8	0	0	0	0	0	0	0	0	0	0	8	
Bicycles	0	0	0	0	0	0	0	0	0	0	0	0	0	0	0	0	0	
Railroad																		
Stopped Buses																		

Comments:

Type of peak hour being reported: Intersection Peak

Method for determining peak hour: Total Entering Volume

LOCATION: 4th St -- C St
CITY/STATE: Hayward, CA

QC JOB #: 14606106
DATE: Tue, Jan 23 2018

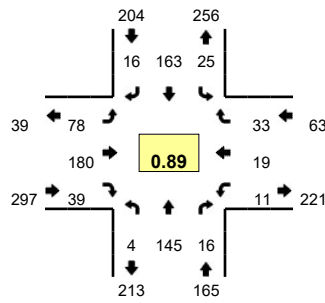

Peak-Hour: 4:00 PM -- 5:00 PM
Peak 15-Min: 4:15 PM -- 4:30 PM

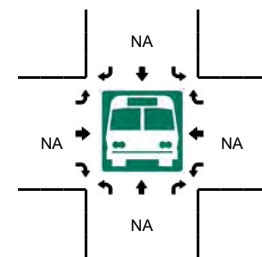
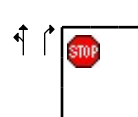
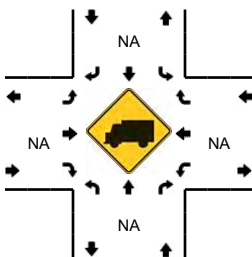
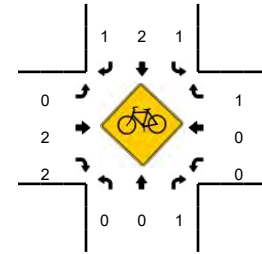
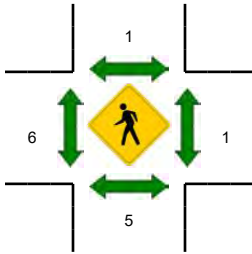
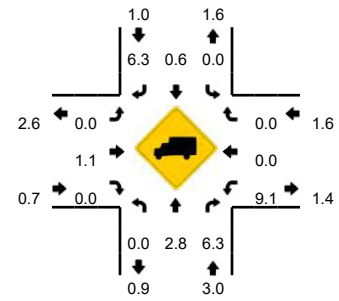



















5-Min Count Period Beginning At	4th St (Northbound)				4th St (Southbound)				C St (Eastbound)				C St (Westbound)				Total	Hourly Totals	
	Left	Thru	Right	U	Left	Thru	Right	U	Left	Thru	Right	U	Left	Thru	Right	U			
4:00 PM	0	13	0	0	2	10	0	0	11	21	3	0	0	2	5	0	0	67	
4:05 PM	0	12	3	0	1	13	3	0	2	18	5	0	0	0	1	0	0	63	
4:10 PM	0	8	0	0	4	10	1	0	4	14	2	0	0	2	2	0	0	47	
4:15 PM	1	6	0	0	3	22	3	0	6	26	6	0	1	0	2	0	0	76	
4:20 PM	1	17	1	0	5	15	2	0	9	10	1	0	0	3	7	0	0	71	
4:25 PM	1	17	1	0	3	10	1	0	2	8	2	0	4	4	5	0	0	58	
4:30 PM	0	23	1	0	4	11	1	0	12	9	5	0	2	1	3	0	0	72	
4:35 PM	0	7	3	0	1	18	1	0	5	14	5	0	0	0	1	0	0	55	
4:40 PM	0	5	2	0	0	16	2	0	7	10	3	0	0	0	1	0	0	46	
4:45 PM	1	10	2	0	1	15	0	0	7	15	2	0	1	1	3	0	0	58	
4:50 PM	0	17	2	0	0	12	0	0	8	21	2	0	1	0	0	0	0	63	
4:55 PM	0	10	1	0	1	11	2	0	5	14	3	0	2	1	3	0	0	53	729
5:00 PM	1	16	0	0	1	6	0	0	11	11	1	0	2	1	2	0	0	52	714
5:05 PM	0	17	1	0	3	10	1	0	4	17	5	0	0	3	0	0	0	61	712
5:10 PM	1	6	0	0	4	19	0	0	5	11	4	0	1	2	1	0	0	54	719
5:15 PM	1	12	2	0	5	15	0	0	3	13	3	0	0	2	1	0	0	57	700
5:20 PM	0	8	1	0	1	12	2	0	9	10	3	0	1	0	1	0	0	48	677
5:25 PM	0	10	2	0	2	19	1	0	10	16	4	0	4	3	2	0	0	73	692
5:30 PM	0	14	2	0	1	18	1	0	7	10	1	0	0	0	3	0	0	57	677
5:35 PM	0	7	2	0	2	17	2	0	13	8	4	0	1	1	1	0	0	58	680
5:40 PM	0	7	2	0	2	18	1	0	13	8	4	0	1	1	1	0	0	58	692
5:45 PM	1	6	1	0	2	23	1	0	3	11	2	0	1	0	4	0	0	55	689
5:50 PM	0	6	1	0	2	12	0	0	7	14	6	0	1	1	1	0	0	51	677
5:55 PM	0	7	0	0	2	11	0	0	3	12	1	0	2	0	0	0	0	38	662
Peak 15-Min Flowrates	Northbound				Southbound				Eastbound				Westbound				Total		
	Left	Thru	Right	U	Left	Thru	Right	U	Left	Thru	Right	U	Left	Thru	Right	U			
All Vehicles	12	160	8	0	44	188	24	0	68	176	36	0	20	28	56	0	0	820	
Heavy Trucks	0	4	0	0	0	0	0	0	0	0	0	0	4	0	0	0	0	8	
Pedestrians		8				0				8				0				16	
Bicycles	0	0	1		0	0	0		0	0	0		0	0	0			1	
Railroad																			
Stopped Buses																			

Comments:

Attachment B: Existing Conditions Synchro Output Sheets



















HCM 2010 Signalized Intersection Summary
1: 4th St. & A St.

Existing (AM)
02/26/2018

												
Movement	EBL	EBT	EBR	WBL	WBT	WBR	NBL	NBT	NBR	SBL	SBT	SBR
Lane Configurations												
Traffic Volume (veh/h)	7	1101	59	243	1701	18	84	54	205	19	21	5
Future Volume (veh/h)	7	1101	59	243	1701	18	84	54	205	19	21	5
Number	5	2	12	1	6	16	3	8	18	7	4	14
Initial Q (Qb), veh	0	0	0	0	0	0	0	0	0	0	0	0
Ped-Bike Adj(A_pbT)	1.00		1.00	1.00		0.97	0.99		0.97	0.99		0.99
Parking Bus, Adj	1.00	1.00	1.00	1.00	1.00	1.00	1.00	1.00	1.00	1.00	1.00	1.00
Adj Sat Flow, veh/h/ln	1863	1863	1900	1863	1863	1900	1900	1863	1863	1900	1863	1900
Adj Flow Rate, veh/h	7	1135	61	251	1754	19	87	56	211	20	22	5
Adj No. of Lanes	1	2	0	1	2	0	0	1	1	0	1	0
Peak Hour Factor	0.97	0.97	0.97	0.97	0.97	0.97	0.97	0.97	0.97	0.97	0.97	0.97
Percent Heavy Veh, %	2	2	2	2	2	2	2	2	2	2	2	2
Cap, veh/h	13	1894	102	285	2539	27	180	97	245	85	80	14
Arrive On Green	0.01	0.55	0.55	0.16	0.71	0.71	0.16	0.16	0.16	0.16	0.16	0.16
Sat Flow, veh/h	1774	3416	184	1774	3585	39	763	612	1542	209	506	85
Grp Volume(v), veh/h	7	588	608	251	864	909	143	0	211	47	0	0
Grp Sat Flow(s),veh/h/ln	1774	1770	1830	1774	1770	1855	1376	0	1542	800	0	0
Q Serve(g_s), s	0.4	22.0	22.0	13.7	27.6	27.8	0.0	0.0	13.2	0.3	0.0	0.0
Cycle Q Clear(g_c), s	0.4	22.0	22.0	13.7	27.6	27.8	10.3	0.0	13.2	10.5	0.0	0.0
Prop In Lane	1.00		0.10	1.00		0.02	0.61		1.00	0.43		0.11
Lane Grp Cap(c), veh/h	13	981	1015	285	1253	1314	277	0	245	179	0	0
V/C Ratio(X)	0.56	0.60	0.60	0.88	0.69	0.69	0.52	0.00	0.86	0.26	0.00	0.00
Avail Cap(c_a), veh/h	179	981	1015	447	1253	1314	434	0	404	325	0	0
HCM Platoon Ratio	1.00	1.00	1.00	1.00	1.00	1.00	1.00	1.00	1.00	1.00	1.00	1.00
Upstream Filter(I)	1.00	1.00	1.00	1.00	1.00	1.00	1.00	0.00	1.00	1.00	0.00	0.00
Uniform Delay (d), s/veh	49.1	14.7	14.7	40.7	8.3	8.3	39.2	0.0	40.7	36.3	0.0	0.0
Incr Delay (d2), s/veh	13.6	2.7	2.6	7.8	3.1	3.0	0.6	0.0	5.2	0.3	0.0	0.0
Initial Q Delay(d3),s/veh	0.0	0.0	0.0	0.0	0.0	0.0	0.0	0.0	0.0	0.0	0.0	0.0
%ile BackOfQ(50%),veh/ln	0.2	11.3	11.7	7.3	14.3	15.0	3.7	0.0	6.0	1.1	0.0	0.0
LnGrp Delay(d),s/veh	62.6	17.4	17.4	48.5	11.4	11.3	39.8	0.0	45.8	36.6	0.0	0.0
LnGrp LOS	E	B	B	D	B	B	D		D	D		
Approach Vol, veh/h		1203			2024			354			47	
Approach Delay, s/veh		17.7			15.9			43.4			36.6	
Approach LOS		B			B			D			D	
Timer	1	2	3	4	5	6	7	8				
Assigned Phs	1	2		4	5	6		8				
Phs Duration (G+Y+Rc), s	20.0	59.5		19.7	4.7	74.8		19.7				
Change Period (Y+Rc), s	4.0	4.5		4.0	4.0	4.5		4.0				
Max Green Setting (Gmax), s	25.0	55.0		26.0	10.0	55.0		26.0				
Max Q Clear Time (g_c+I1), s	15.7	24.0		12.5	2.4	29.8		15.2				
Green Ext Time (p_c), s	0.3	10.0		0.1	0.0	15.8		0.5				
Intersection Summary												
HCM 2010 Ctrl Delay				19.5								
HCM 2010 LOS				B								
Notes												

HCM 2010 Signalized Intersection Summary
2: 4th St. & B St.

Existing (AM)
02/26/2018

												
Movement	EBL	EBT	EBR	WBL	WBT	WBR	NBL	NBT	NBR	SBL	SBT	SBR
Lane Configurations												
Traffic Volume (veh/h)	13	410	15	13	728	80	26	250	25	77	178	64
Future Volume (veh/h)	13	410	15	13	728	80	26	250	25	77	178	64
Number	5	2	12	1	6	16	3	8	18	7	4	14
Initial Q (Qb), veh	0	0	0	0	0	0	0	0	0	0	0	0
Ped-Bike Adj(A_pbT)	1.00		0.99	1.00		0.97	0.99		0.98	0.99		0.98
Parking Bus, Adj	1.00	1.00	1.00	1.00	1.00	1.00	1.00	1.00	1.00	1.00	1.00	1.00
Adj Sat Flow, veh/h/ln	1863	1863	1900	1900	1863	1900	1900	1863	1900	1863	1863	1900
Adj Flow Rate, veh/h	14	441	16	14	783	86	28	269	27	83	191	69
Adj No. of Lanes	1	1	0	0	1	0	0	1	0	1	1	0
Peak Hour Factor	0.93	0.93	0.93	0.93	0.93	0.93	0.93	0.93	0.93	0.93	0.93	0.93
Percent Heavy Veh, %	2	2	2	2	2	2	2	2	2	2	2	2
Cap, veh/h	415	1061	39	78	968	105	95	361	34	351	322	116
Arrive On Green	0.59	0.59	0.59	0.59	0.59	0.59	0.25	0.25	0.25	0.25	0.25	0.25
Sat Flow, veh/h	635	1786	65	9	1629	177	71	1457	139	1068	1298	469
Grp Volume(v), veh/h	14	0	457	883	0	0	324	0	0	83	0	260
Grp Sat Flow(s),veh/h/ln	635	0	1851	1816	0	0	1667	0	0	1068	0	1766
Q Serve(g_s), s	0.0	0.0	6.7	0.0	0.0	0.0	2.8	0.0	0.0	0.0	0.0	6.6
Cycle Q Clear(g_c), s	0.8	0.0	6.7	19.3	0.0	0.0	9.3	0.0	0.0	4.7	0.0	6.6
Prop In Lane	1.00		0.04	0.02		0.10	0.09		0.08	1.00		0.27
Lane Grp Cap(c), veh/h	415	0	1100	1151	0	0	490	0	0	351	0	438
V/C Ratio(X)	0.03	0.00	0.42	0.77	0.00	0.00	0.66	0.00	0.00	0.24	0.00	0.59
Avail Cap(c_a), veh/h	476	0	1279	1325	0	0	1086	0	0	718	0	1046
HCM Platoon Ratio	1.00	1.00	1.00	1.00	1.00	1.00	1.00	1.00	1.00	1.00	1.00	1.00
Upstream Filter(I)	1.00	0.00	1.00	1.00	0.00	0.00	1.00	0.00	0.00	1.00	0.00	1.00
Uniform Delay (d), s/veh	4.3	0.0	5.5	8.1	0.0	0.0	17.6	0.0	0.0	16.1	0.0	16.8
Incr Delay (d2), s/veh	0.2	0.0	1.2	3.2	0.0	0.0	0.6	0.0	0.0	0.1	0.0	0.5
Initial Q Delay(d3),s/veh	0.0	0.0	0.0	0.0	0.0	0.0	0.0	0.0	0.0	0.0	0.0	0.0
%ile BackOfQ(50%),veh/ln	0.1	0.0	3.8	10.3	0.0	0.0	4.3	0.0	0.0	1.0	0.0	3.2
LnGrp Delay(d),s/veh	4.5	0.0	6.7	11.3	0.0	0.0	18.2	0.0	0.0	16.2	0.0	17.3
LnGrp LOS	A		A	B			B			B		B
Approach Vol, veh/h		471			883			324				343
Approach Delay, s/veh		6.6			11.3			18.2				17.0
Approach LOS		A			B			B				B
Timer	1	2	3	4	5	6	7	8				
Assigned Phs		2		4		6		8				
Phs Duration (G+Y+Rc), s		34.1		16.6		34.1		16.6				
Change Period (Y+Rc), s		4.0		4.0		4.0		* 4				
Max Green Setting (Gmax), s		35.0		30.0		35.0		* 30				
Max Q Clear Time (g_c+I1), s		8.7		8.6		21.3		11.3				
Green Ext Time (p_c), s		10.8		1.2		8.8		1.2				
Intersection Summary												
HCM 2010 Ctrl Delay				12.3								
HCM 2010 LOS				B								
Notes												

HCM 2010 AWSC
3: 4th St. & C St.

Existing (AM)
02/26/2018

Intersection	
Intersection Delay, s/veh	12.9
Intersection LOS	B

Movement	EBL	EBT	EBR	WBL	WBT	WBR	NBL	NBT	NBR	SBL	SBT	SBR
Lane Configurations		↕			↕			↕	↕		↕	
Traffic Vol, veh/h	32	119	19	27	59	36	25	234	23	43	143	20
Future Vol, veh/h	32	119	19	27	59	36	25	234	23	43	143	20
Peak Hour Factor	0.82	0.82	0.82	0.82	0.82	0.82	0.82	0.82	0.82	0.82	0.82	0.82
Heavy Vehicles, %	2	2	2	2	2	2	2	2	2	2	2	2
Mvmt Flow	39	145	23	33	72	44	30	285	28	52	174	24
Number of Lanes	0	1	0	0	1	0	0	1	1	0	1	0
Approach	EB			WB			NB			SB		
Opposing Approach	WB			EB			SB			NB		
Opposing Lanes	1			1			1			2		
Conflicting Approach Left	SB			NB			EB			WB		
Conflicting Lanes Left	1			2			1			1		
Conflicting Approach Right	NB			SB			WB			EB		
Conflicting Lanes Right	2			1			1			1		
HCM Control Delay	12			10.9			14.7			12.5		
HCM LOS	B			B			B			B		

Lane	NBLn1	NBLn2	EBLn1	WBLn1	SBLn1
Vol Left, %	10%	0%	19%	22%	21%
Vol Thru, %	90%	0%	70%	48%	69%
Vol Right, %	0%	100%	11%	30%	10%
Sign Control	Stop	Stop	Stop	Stop	Stop
Traffic Vol by Lane	259	23	170	122	206
LT Vol	25	0	32	27	43
Through Vol	234	0	119	59	143
RT Vol	0	23	19	36	20
Lane Flow Rate	316	28	207	149	251
Geometry Grp	7	7	2	2	5
Degree of Util (X)	0.527	0.041	0.339	0.244	0.397
Departure Headway (Hd)	6.009	5.251	5.882	5.911	5.687
Convergence, Y/N	Yes	Yes	Yes	Yes	Yes
Cap	597	679	607	604	631
Service Time	3.765	3.005	3.949	3.983	3.747
HCM Lane V/C Ratio	0.529	0.041	0.341	0.247	0.398
HCM Control Delay	15.3	8.2	12	10.9	12.5
HCM Lane LOS	C	A	B	B	B
HCM 95th-tile Q	3.1	0.1	1.5	1	1.9

Queues
1: 4th St. & A St.

Existing (AM)
02/26/2018

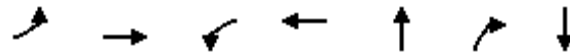

Lane Group	EBL	EBT	WBL	WBT	NBT	NBR	SBT
Lane Group Flow (vph)	7	1196	251	1773	143	211	47
v/c Ratio	0.09	0.62	0.80	0.67	0.65	0.52	0.21
Control Delay	53.7	19.0	59.4	9.6	55.4	10.2	37.1
Queue Delay	0.0	0.0	0.0	0.0	0.0	0.0	0.0
Total Delay	53.7	19.0	59.4	9.6	55.4	10.2	37.1
Queue Length 50th (ft)	4	252	152	208	87	0	24
Queue Length 95th (ft)	21	470	273	615	159	62	59
Internal Link Dist (ft)		360		531	435		156
Turn Bay Length (ft)	72		110			95	
Base Capacity (vph)	177	1942	444	2664	402	566	413
Starvation Cap Reductn	0	0	0	0	0	0	0
Spillback Cap Reductn	0	0	0	0	0	0	0
Storage Cap Reductn	0	0	0	0	0	0	0
Reduced v/c Ratio	0.04	0.62	0.57	0.67	0.36	0.37	0.11
Intersection Summary							

Queues
2: 4th St. & B St.

Existing (AM)
02/26/2018

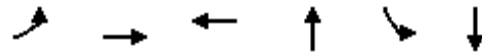





















Lane Group	EBL	EBT	WBT	NBT	SBL	SBT
Lane Group Flow (vph)	14	457	883	324	83	260
v/c Ratio	0.04	0.40	0.78	0.72	0.57	0.60
Control Delay	6.1	7.5	15.9	28.2	34.8	22.6
Queue Delay	0.0	0.0	0.0	0.0	0.0	0.0
Total Delay	6.1	7.5	15.9	28.2	34.8	22.6
Queue Length 50th (ft)	2	63	177	97	25	68
Queue Length 95th (ft)	9	153	#510	168	63	128
Internal Link Dist (ft)		316	315	398		435
Turn Bay Length (ft)	130				105	
Base Capacity (vph)	357	1154	1137	978	333	958
Starvation Cap Reductn	0	0	0	0	0	0
Spillback Cap Reductn	0	0	0	0	0	0
Storage Cap Reductn	0	0	0	0	0	0
Reduced v/c Ratio	0.04	0.40	0.78	0.33	0.25	0.27

Intersection Summary

95th percentile volume exceeds capacity, queue may be longer.
Queue shown is maximum after two cycles.



















HCM 2010 Signalized Intersection Summary
1: 4th St. & A St.

Existing (PM)
02/26/2018

												
Movement	EBL	EBT	EBR	WBL	WBT	WBR	NBL	NBT	NBR	SBL	SBT	SBR
Lane Configurations												
Traffic Volume (veh/h)	11	1423	54	231	1141	7	84	7	263	39	23	15
Future Volume (veh/h)	11	1423	54	231	1141	7	84	7	263	39	23	15
Number	5	2	12	1	6	16	3	8	18	7	4	14
Initial Q (Qb), veh	0	0	0	0	0	0	0	0	0	0	0	0
Ped-Bike Adj(A_pbT)	1.00		0.97	1.00		0.98	1.00		1.00	1.00		0.98
Parking Bus, Adj	1.00	1.00	1.00	1.00	1.00	1.00	1.00	1.00	1.00	1.00	1.00	1.00
Adj Sat Flow, veh/h/ln	1881	1881	1900	1881	1881	1900	1900	1881	1881	1900	1881	1900
Adj Flow Rate, veh/h	11	1482	56	241	1189	7	88	7	274	41	24	16
Adj No. of Lanes	1	2	0	1	2	0	0	1	1	0	1	0
Peak Hour Factor	0.96	0.96	0.96	0.96	0.96	0.96	0.96	0.96	0.96	0.96	0.96	0.96
Percent Heavy Veh, %	1	1	1	1	1	1	1	1	1	1	1	1
Cap, veh/h	20	1657	62	287	2264	13	358	25	318	174	97	49
Arrive On Green	0.01	0.47	0.47	0.16	0.62	0.62	0.20	0.20	0.20	0.20	0.20	0.20
Sat Flow, veh/h	1792	3508	132	1792	3642	21	1327	126	1599	505	487	244
Grp Volume(v), veh/h	11	753	785	241	583	613	95	0	274	81	0	0
Grp Sat Flow(s),veh/h/ln	1792	1787	1853	1792	1787	1877	1453	0	1599	1235	0	0
Q Serve(g_s), s	0.5	28.5	28.7	9.7	13.6	13.6	0.0	0.0	12.3	1.3	0.0	0.0
Cycle Q Clear(g_c), s	0.5	28.5	28.7	9.7	13.6	13.6	3.8	0.0	12.3	5.1	0.0	0.0
Prop In Lane	1.00		0.07	1.00		0.01	0.93		1.00	0.51		0.20
Lane Grp Cap(c), veh/h	20	844	875	287	1111	1166	383	0	318	319	0	0
V/C Ratio(X)	0.56	0.89	0.90	0.84	0.53	0.53	0.25	0.00	0.86	0.25	0.00	0.00
Avail Cap(c_a), veh/h	242	844	875	604	1111	1166	595	0	561	524	0	0
HCM Platoon Ratio	1.00	1.00	1.00	1.00	1.00	1.00	1.00	1.00	1.00	1.00	1.00	1.00
Upstream Filter(I)	1.00	1.00	1.00	1.00	1.00	1.00	1.00	0.00	1.00	1.00	0.00	0.00
Uniform Delay (d), s/veh	36.5	17.8	17.9	30.2	7.9	7.9	25.3	0.0	28.7	25.4	0.0	0.0
Incr Delay (d2), s/veh	9.0	13.8	13.8	2.5	1.8	1.7	0.1	0.0	2.7	0.2	0.0	0.0
Initial Q Delay(d3),s/veh	0.0	0.0	0.0	0.0	0.0	0.0	0.0	0.0	0.0	0.0	0.0	0.0
%ile BackOfQ(50%),veh/ln	0.3	17.2	18.0	5.0	7.2	7.5	1.7	0.0	5.7	1.5	0.0	0.0
LnGrp Delay(d),s/veh	45.5	31.6	31.7	32.7	9.7	9.6	25.4	0.0	31.4	25.6	0.0	0.0
LnGrp LOS	D	C	C	C	A	A	C		C	C		
Approach Vol, veh/h		1549			1437			369			81	
Approach Delay, s/veh		31.8			13.5			29.9			25.6	
Approach LOS		C			B			C			C	
Timer	1	2	3	4	5	6	7	8				
Assigned Phs	1	2		4	5	6		8				
Phs Duration (G+Y+Rc), s	15.9	39.5		18.7	4.8	50.6		18.7				
Change Period (Y+Rc), s	4.0	4.5		4.0	4.0	4.5		4.0				
Max Green Setting (Gmax), s	25.0	35.0		26.0	10.0	35.0		26.0				
Max Q Clear Time (g_c+I1), s	11.7	30.7		7.1	2.5	15.6		14.3				
Green Ext Time (p_c), s	0.3	3.3		0.2	0.0	8.2		0.5				
Intersection Summary												
HCM 2010 Ctrl Delay				23.8								
HCM 2010 LOS				C								
Notes												

HCM 2010 Signalized Intersection Summary
2: 4th St. & B St.

Existing (PM)
02/26/2018

												
Movement	EBL	EBT	EBR	WBL	WBT	WBR	NBL	NBT	NBR	SBL	SBT	SBR
Lane Configurations												
Traffic Volume (veh/h)	62	541	11	14	511	113	7	177	52	77	186	34
Future Volume (veh/h)	62	541	11	14	511	113	7	177	52	77	186	34
Number	5	2	12	1	6	16	3	8	18	7	4	14
Initial Q (Qb), veh	0	0	0	0	0	0	0	0	0	0	0	0
Ped-Bike Adj(A_pbT)	1.00		0.97	1.00		0.97	1.00		1.00	1.00		0.97
Parking Bus, Adj	1.00	1.00	1.00	1.00	1.00	1.00	1.00	1.00	1.00	1.00	1.00	1.00
Adj Sat Flow, veh/h/ln	1881	1881	1900	1900	1881	1900	1900	1881	1900	1881	1881	1900
Adj Flow Rate, veh/h	67	582	12	15	549	122	8	190	56	83	200	37
Adj No. of Lanes	1	1	0	0	1	0	0	1	0	1	1	0
Peak Hour Factor	0.93	0.93	0.93	0.93	0.93	0.93	0.93	0.93	0.93	0.93	0.93	0.93
Percent Heavy Veh, %	1	1	1	1	1	1	1	1	1	1	1	1
Cap, veh/h	620	1100	23	98	878	192	96	279	80	428	312	58
Arrive On Green	0.60	0.60	0.60	0.60	0.60	0.60	0.20	0.20	0.20	0.20	0.20	0.20
Sat Flow, veh/h	769	1835	38	13	1464	319	23	1374	395	1138	1536	284
Grp Volume(v), veh/h	67	0	594	686	0	0	254	0	0	83	0	237
Grp Sat Flow(s),veh/h/ln	769	0	1873	1796	0	0	1792	0	0	1138	0	1821
Q Serve(g_s), s	0.0	0.0	7.5	0.0	0.0	0.0	0.5	0.0	0.0	0.0	0.0	4.8
Cycle Q Clear(g_c), s	1.7	0.0	7.5	9.9	0.0	0.0	5.3	0.0	0.0	2.2	0.0	4.8
Prop In Lane	1.00		0.02	0.02		0.18	0.03		0.22	1.00		0.16
Lane Grp Cap(c), veh/h	620	0	1123	1167	0	0	456	0	0	428	0	370
V/C Ratio(X)	0.11	0.00	0.53	0.59	0.00	0.00	0.56	0.00	0.00	0.19	0.00	0.64
Avail Cap(c_a), veh/h	822	0	1615	1630	0	0	1406	0	0	1037	0	1345
HCM Platoon Ratio	1.00	1.00	1.00	1.00	1.00	1.00	1.00	1.00	1.00	1.00	1.00	1.00
Upstream Filter(I)	1.00	0.00	1.00	1.00	0.00	0.00	1.00	0.00	0.00	1.00	0.00	1.00
Uniform Delay (d), s/veh	3.6	0.0	4.8	5.2	0.0	0.0	15.0	0.0	0.0	13.8	0.0	14.8
Incr Delay (d2), s/veh	0.4	0.0	1.8	1.0	0.0	0.0	0.4	0.0	0.0	0.1	0.0	0.7
Initial Q Delay(d3),s/veh	0.0	0.0	0.0	0.0	0.0	0.0	0.0	0.0	0.0	0.0	0.0	0.0
%ile BackOfQ(50%),veh/ln	0.4	0.0	4.4	5.1	0.0	0.0	2.7	0.0	0.0	0.8	0.0	2.5
LnGrp Delay(d),s/veh	4.0	0.0	6.5	6.2	0.0	0.0	15.4	0.0	0.0	13.9	0.0	15.5
LnGrp LOS	A		A	A			B			B		B
Approach Vol, veh/h		661			686			254				320
Approach Delay, s/veh		6.3			6.2			15.4				15.1
Approach LOS		A			A			B				B
Timer	1	2	3	4	5	6	7	8				
Assigned Phs		2		4		6		8				
Phs Duration (G+Y+Rc), s		28.3		12.3		28.3		12.3				
Change Period (Y+Rc), s		4.0		4.0		4.0		* 4				
Max Green Setting (Gmax), s		35.0		30.0		35.0		* 30				
Max Q Clear Time (g_c+I1), s		9.5		6.8		11.9		7.3				
Green Ext Time (p_c), s		14.8		1.1		9.4		1.0				
Intersection Summary												
HCM 2010 Ctrl Delay			8.9									
HCM 2010 LOS			A									
Notes												

HCM 2010 AWSC
3: 4th St. & C St.

Existing (PM)
02/26/2018

Intersection	
Intersection Delay, s/veh	11.6
Intersection LOS	B

Movement	EBL	EBT	EBR	WBL	WBT	WBR	NBL	NBT	NBR	SBL	SBT	SBR
Lane Configurations		↕			↕			↕	↕		↕	
Traffic Vol, veh/h	78	180	39	11	19	33	4	145	16	25	163	16
Future Vol, veh/h	78	180	39	11	19	33	4	145	16	25	163	16
Peak Hour Factor	0.89	0.89	0.89	0.89	0.89	0.89	0.89	0.89	0.89	0.89	0.89	0.89
Heavy Vehicles, %	1	1	1	1	1	1	1	1	1	1	1	1
Mvmt Flow	88	202	44	12	21	37	4	163	18	28	183	18
Number of Lanes	0	1	0	0	1	0	0	1	1	0	1	0

Approach	EB	WB	NB	SB
Opposing Approach	WB	EB	SB	NB
Opposing Lanes	1	1	1	2
Conflicting Approach Left	SB	NB	EB	WB
Conflicting Lanes Left	1	2	1	1
Conflicting Approach Right	NB	SB	WB	EB
Conflicting Lanes Right	2	1	1	1
HCM Control Delay	12.9	9	10.7	11.3
HCM LOS	B	A	B	B

Lane	NBLn1	NBLn2	EBLn1	WBLn1	SBLn1
Vol Left, %	3%	0%	26%	17%	12%
Vol Thru, %	97%	0%	61%	30%	80%
Vol Right, %	0%	100%	13%	52%	8%
Sign Control	Stop	Stop	Stop	Stop	Stop
Traffic Vol by Lane	149	16	297	63	204
LT Vol	4	0	78	11	25
Through Vol	145	0	180	19	163
RT Vol	0	16	39	33	16
Lane Flow Rate	167	18	334	71	229
Geometry Grp	7	7	2	2	5
Degree of Util (X)	0.277	0.026	0.479	0.105	0.345
Departure Headway (Hd)	5.949	5.226	5.163	5.35	5.414
Convergence, Y/N	Yes	Yes	Yes	Yes	Yes
Cap	604	685	697	669	665
Service Time	3.684	2.96	3.193	3.393	3.448
HCM Lane V/C Ratio	0.276	0.026	0.479	0.106	0.344
HCM Control Delay	11	8.1	12.9	9	11.3
HCM Lane LOS	B	A	B	A	B
HCM 95th-tile Q	1.1	0.1	2.6	0.4	1.5

Queues
1: 4th St. & A St.

Existing (PM)
02/26/2018

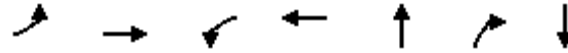

Lane Group	EBL	EBT	WBL	WBT	NBT	NBR	SBT
Lane Group Flow (vph)	11	1538	241	1196	95	274	81
v/c Ratio	0.10	0.89	0.70	0.47	0.47	0.59	0.36
Control Delay	40.3	28.0	40.0	7.3	37.2	9.4	29.5
Queue Delay	0.0	0.0	0.0	0.0	0.0	0.0	0.0
Total Delay	40.3	28.0	40.0	7.3	37.2	9.4	29.5
Queue Length 50th (ft)	5	286	97	74	39	0	28
Queue Length 95th (ft)	25	#766	212	327	90	59	71
Internal Link Dist (ft)		360		531	435		156
Turn Bay Length (ft)	72		110			95	
Base Capacity (vph)	248	1730	620	2584	498	755	543
Starvation Cap Reductn	0	0	0	0	0	0	0
Spillback Cap Reductn	0	0	0	0	0	0	0
Storage Cap Reductn	0	0	0	0	0	0	0
Reduced v/c Ratio	0.04	0.89	0.39	0.46	0.19	0.36	0.15

Intersection Summary

95th percentile volume exceeds capacity, queue may be longer.
Queue shown is maximum after two cycles.

Queues
2: 4th St. & B St.

Existing (PM)
02/26/2018

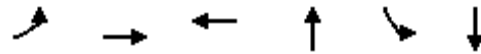



















Lane Group	EBL	EBT	WBT	NBT	SBL	SBT
Lane Group Flow (vph)	67	594	686	254	83	237
v/c Ratio	0.17	0.57	0.68	0.50	0.35	0.51
Control Delay	6.8	9.4	11.4	16.7	19.6	18.3
Queue Delay	0.0	0.0	0.0	0.0	0.0	0.0
Total Delay	6.8	9.4	11.4	16.7	19.6	18.3
Queue Length 50th (ft)	7	76	93	42	15	42
Queue Length 95th (ft)	28	208	262	123	56	120
Internal Link Dist (ft)		316	315	398		435
Turn Bay Length (ft)	130				105	
Base Capacity (vph)	586	1523	1469	1348	679	1323
Starvation Cap Reductn	0	0	0	0	0	0
Spillback Cap Reductn	0	0	0	0	0	0
Storage Cap Reductn	0	0	0	0	0	0
Reduced v/c Ratio	0.11	0.39	0.47	0.19	0.12	0.18
Intersection Summary						

Attachment C: Existing Plus Project Conditions Synchro Output Sheets



















HCM 2010 Signalized Intersection Summary
1: 4th St. & A St.

Existing Plus Project (AM)
02/26/2018

												
Movement	EBL	EBT	EBR	WBL	WBT	WBR	NBL	NBT	NBR	SBL	SBT	SBR
Lane Configurations												
Traffic Volume (veh/h)	7	1101	61	244	1701	18	89	54	207	19	21	5
Future Volume (veh/h)	7	1101	61	244	1701	18	89	54	207	19	21	5
Number	5	2	12	1	6	16	3	8	18	7	4	14
Initial Q (Qb), veh	0	0	0	0	0	0	0	0	0	0	0	0
Ped-Bike Adj(A_pbT)	1.00		1.00	1.00		0.97	0.99		0.97	0.99		0.99
Parking Bus, Adj	1.00	1.00	1.00	1.00	1.00	1.00	1.00	1.00	1.00	1.00	1.00	1.00
Adj Sat Flow, veh/h/ln	1863	1863	1900	1863	1863	1900	1900	1863	1863	1900	1863	1900
Adj Flow Rate, veh/h	7	1135	63	252	1754	19	92	56	213	20	22	5
Adj No. of Lanes	1	2	0	1	2	0	0	1	1	0	1	0
Peak Hour Factor	0.97	0.97	0.97	0.97	0.97	0.97	0.97	0.97	0.97	0.97	0.97	0.97
Percent Heavy Veh, %	2	2	2	2	2	2	2	2	2	2	2	2
Cap, veh/h	13	1885	105	286	2536	27	179	89	247	79	74	12
Arrive On Green	0.01	0.55	0.55	0.16	0.71	0.71	0.16	0.16	0.16	0.16	0.16	0.16
Sat Flow, veh/h	1774	3410	189	1774	3585	39	753	557	1542	172	462	76
Grp Volume(v), veh/h	7	589	609	252	864	909	148	0	213	47	0	0
Grp Sat Flow(s),veh/h/ln	1774	1770	1829	1774	1770	1855	1310	0	1542	710	0	0
Q Serve(g_s), s	0.4	22.2	22.2	13.8	27.8	28.0	0.0	0.0	13.4	0.3	0.0	0.0
Cycle Q Clear(g_c), s	0.4	22.2	22.2	13.8	27.8	28.0	11.4	0.0	13.4	11.7	0.0	0.0
Prop In Lane	1.00		0.10	1.00		0.02	0.62		1.00	0.43		0.11
Lane Grp Cap(c), veh/h	13	978	1011	286	1251	1312	268	0	247	165	0	0
V/C Ratio(X)	0.56	0.60	0.60	0.88	0.69	0.69	0.55	0.00	0.86	0.28	0.00	0.00
Avail Cap(c_a), veh/h	178	978	1011	446	1251	1312	422	0	403	309	0	0
HCM Platoon Ratio	1.00	1.00	1.00	1.00	1.00	1.00	1.00	1.00	1.00	1.00	1.00	1.00
Upstream Filter(I)	1.00	1.00	1.00	1.00	1.00	1.00	1.00	0.00	1.00	1.00	0.00	0.00
Uniform Delay (d), s/veh	49.2	14.9	14.9	40.8	8.3	8.4	39.7	0.0	40.7	36.4	0.0	0.0
Incr Delay (d2), s/veh	13.6	2.7	2.7	8.1	3.1	3.0	0.7	0.0	5.6	0.3	0.0	0.0
Initial Q Delay(d3),s/veh	0.0	0.0	0.0	0.0	0.0	0.0	0.0	0.0	0.0	0.0	0.0	0.0
%ile BackOfQ(50%),veh/ln	0.2	11.5	11.9	7.4	14.5	15.2	3.9	0.0	6.1	1.1	0.0	0.0
LnGrp Delay(d),s/veh	62.8	17.6	17.6	48.8	11.5	11.4	40.3	0.0	46.3	36.8	0.0	0.0
LnGrp LOS	E	B	B	D	B	B	D		D	D		
Approach Vol, veh/h		1205			2025			361			47	
Approach Delay, s/veh		17.9			16.1			43.8			36.8	
Approach LOS		B			B			D			D	
Timer	1	2	3	4	5	6	7	8				
Assigned Phs	1	2		4	5	6		8				
Phs Duration (G+Y+Rc), s	20.1	59.5		19.9	4.7	74.9		19.9				
Change Period (Y+Rc), s	4.0	4.5		4.0	4.0	4.5		4.0				
Max Green Setting (Gmax), s	25.0	55.0		26.0	10.0	55.0		26.0				
Max Q Clear Time (g_c+I1), s	15.8	24.2		13.7	2.4	30.0		15.4				
Green Ext Time (p_c), s	0.3	10.0		0.1	0.0	15.8		0.5				
Intersection Summary												
HCM 2010 Ctrl Delay				19.7								
HCM 2010 LOS				B								
Notes												

HCM 2010 Signalized Intersection Summary
2: 4th St. & B St.

Existing Plus Project (AM)
02/26/2018

												
Movement	EBL	EBT	EBR	WBL	WBT	WBR	NBL	NBT	NBR	SBL	SBT	SBR
Lane Configurations												
Traffic Volume (veh/h)	13	412	15	20	734	87	26	250	28	80	178	64
Future Volume (veh/h)	13	412	15	20	734	87	26	250	28	80	178	64
Number	5	2	12	1	6	16	3	8	18	7	4	14
Initial Q (Qb), veh	0	0	0	0	0	0	0	0	0	0	0	0
Ped-Bike Adj(A_pbT)	1.00		0.99	1.00		0.97	0.99		0.98	0.99		0.98
Parking Bus, Adj	1.00	1.00	1.00	1.00	1.00	1.00	1.00	1.00	1.00	1.00	1.00	1.00
Adj Sat Flow, veh/h/ln	1863	1863	1900	1900	1863	1900	1900	1863	1900	1863	1863	1900
Adj Flow Rate, veh/h	14	443	16	22	789	94	28	269	30	86	191	69
Adj No. of Lanes	1	1	0	0	1	0	0	1	0	1	1	0
Peak Hour Factor	0.93	0.93	0.93	0.93	0.93	0.93	0.93	0.93	0.93	0.93	0.93	0.93
Percent Heavy Veh, %	2	2	2	2	2	2	2	2	2	2	2	2
Cap, veh/h	400	1067	39	82	956	112	93	358	38	343	322	116
Arrive On Green	0.60	0.60	0.60	0.60	0.60	0.60	0.25	0.25	0.25	0.25	0.25	0.25
Sat Flow, veh/h	626	1786	65	18	1600	188	71	1443	153	1065	1298	469
Grp Volume(v), veh/h	14	0	459	905	0	0	327	0	0	86	0	260
Grp Sat Flow(s),veh/h/ln	626	0	1851	1805	0	0	1666	0	0	1065	0	1766
Q Serve(g_s), s	0.0	0.0	6.9	2.3	0.0	0.0	2.9	0.0	0.0	0.0	0.0	6.7
Cycle Q Clear(g_c), s	0.9	0.0	6.9	20.7	0.0	0.0	9.7	0.0	0.0	5.1	0.0	6.7
Prop In Lane	1.00		0.03	0.02		0.10	0.09		0.09	1.00		0.27
Lane Grp Cap(c), veh/h	400	0	1106	1150	0	0	489	0	0	343	0	439
V/C Ratio(X)	0.04	0.00	0.42	0.79	0.00	0.00	0.67	0.00	0.00	0.25	0.00	0.59
Avail Cap(c_a), veh/h	448	0	1248	1287	0	0	1059	0	0	694	0	1021
HCM Platoon Ratio	1.00	1.00	1.00	1.00	1.00	1.00	1.00	1.00	1.00	1.00	1.00	1.00
Upstream Filter(I)	1.00	0.00	1.00	1.00	0.00	0.00	1.00	0.00	0.00	1.00	0.00	1.00
Uniform Delay (d), s/veh	4.4	0.0	5.6	8.4	0.0	0.0	18.1	0.0	0.0	16.6	0.0	17.2
Incr Delay (d2), s/veh	0.2	0.0	1.2	3.8	0.0	0.0	0.6	0.0	0.0	0.1	0.0	0.5
Initial Q Delay(d3),s/veh	0.0	0.0	0.0	0.0	0.0	0.0	0.0	0.0	0.0	0.0	0.0	0.0
%ile BackOfQ(50%),veh/ln	0.1	0.0	3.8	11.3	0.0	0.0	4.4	0.0	0.0	1.1	0.0	3.3
LnGrp Delay(d),s/veh	4.5	0.0	6.7	12.2	0.0	0.0	18.7	0.0	0.0	16.7	0.0	17.7
LnGrp LOS	A		A	B			B			B		B
Approach Vol, veh/h		473			905			327				346
Approach Delay, s/veh		6.7			12.2			18.7				17.4
Approach LOS		A			B			B				B
Timer	1	2	3	4	5	6	7	8				
Assigned Phs		2		4		6		8				
Phs Duration (G+Y+Rc), s		35.0		16.9		35.0		16.9				
Change Period (Y+Rc), s		4.0		4.0		4.0		* 4				
Max Green Setting (Gmax), s		35.0		30.0		35.0		* 30				
Max Q Clear Time (g_c+I1), s		8.9		8.7		22.7		11.7				
Green Ext Time (p_c), s		10.8		1.2		8.3		1.2				
Intersection Summary												
HCM 2010 Ctrl Delay				12.8								
HCM 2010 LOS				B								
Notes												

HCM 2010 AWSC
3: 4th St. & C St.

Existing Plus Project (AM)
02/26/2018

Intersection	
Intersection Delay, s/veh	13.1
Intersection LOS	B

Movement	EBL	EBT	EBR	WBL	WBT	WBR	NBL	NBT	NBR	SBL	SBT	SBR
Lane Configurations		↕			↕			↕	↕		↕	
Traffic Vol, veh/h	33	119	19	27	59	36	25	236	23	43	149	21
Future Vol, veh/h	33	119	19	27	59	36	25	236	23	43	149	21
Peak Hour Factor	0.82	0.82	0.82	0.82	0.82	0.82	0.82	0.82	0.82	0.82	0.82	0.82
Heavy Vehicles, %	2	2	2	2	2	2	2	2	2	2	2	2
Mvmt Flow	40	145	23	33	72	44	30	288	28	52	182	26
Number of Lanes	0	1	0	0	1	0	0	1	1	0	1	0
Approach	EB			WB			NB			SB		
Opposing Approach	WB			EB			SB			NB		
Opposing Lanes	1			1			1			2		
Conflicting Approach Left	SB			NB			EB			WB		
Conflicting Lanes Left	1			2			1			1		
Conflicting Approach Right	NB			SB			WB			EB		
Conflicting Lanes Right	2			1			1			1		
HCM Control Delay	12.1			11			14.9			12.7		
HCM LOS	B			B			B			B		

Lane	NBLn1	NBLn2	EBLn1	WBLn1	SBLn1
Vol Left, %	10%	0%	19%	22%	20%
Vol Thru, %	90%	0%	70%	48%	70%
Vol Right, %	0%	100%	11%	30%	10%
Sign Control	Stop	Stop	Stop	Stop	Stop
Traffic Vol by Lane	261	23	171	122	213
LT Vol	25	0	33	27	43
Through Vol	236	0	119	59	149
RT Vol	0	23	19	36	21
Lane Flow Rate	318	28	209	149	260
Geometry Grp	7	7	2	2	5
Degree of Util (X)	0.533	0.041	0.343	0.246	0.411
Departure Headway (Hd)	6.033	5.274	5.921	5.951	5.701
Convergence, Y/N	Yes	Yes	Yes	Yes	Yes
Cap	595	676	605	600	629
Service Time	3.791	3.032	3.989	4.026	3.765
HCM Lane V/C Ratio	0.534	0.041	0.345	0.248	0.413
HCM Control Delay	15.5	8.3	12.1	11	12.7
HCM Lane LOS	C	A	B	B	B
HCM 95th-tile Q	3.1	0.1	1.5	1	2

Queues
1: 4th St. & A St.

Existing Plus Project (AM)
02/26/2018

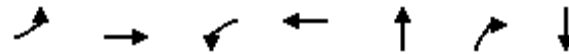

Lane Group	EBL	EBT	WBL	WBT	NBT	NBR	SBT
Lane Group Flow (vph)	7	1198	252	1773	148	213	47
v/c Ratio	0.09	0.62	0.80	0.67	0.67	0.52	0.20
Control Delay	53.9	19.3	59.7	9.7	56.3	10.2	37.0
Queue Delay	0.0	0.0	0.0	0.0	0.0	0.0	0.0
Total Delay	53.9	19.3	59.7	9.7	56.3	10.2	37.0
Queue Length 50th (ft)	4	257	154	213	91	0	24
Queue Length 95th (ft)	21	472	274	615	164	63	59
Internal Link Dist (ft)		360		531	435		156
Turn Bay Length (ft)	72		110			105	
Base Capacity (vph)	177	1935	442	2657	398	566	411
Starvation Cap Reductn	0	0	0	0	0	0	0
Spillback Cap Reductn	0	0	0	0	0	0	0
Storage Cap Reductn	0	0	0	0	0	0	0
Reduced v/c Ratio	0.04	0.62	0.57	0.67	0.37	0.38	0.11
Intersection Summary							

Queues
2: 4th St. & B St.

Existing Plus Project (AM)
02/26/2018

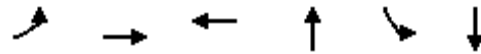



















Lane Group	EBL	EBT	WBT	NBT	SBL	SBT
Lane Group Flow (vph)	14	459	905	327	86	260
v/c Ratio	0.04	0.40	0.80	0.72	0.59	0.59
Control Delay	6.1	7.5	17.3	28.2	36.2	22.5
Queue Delay	0.0	0.0	0.0	0.0	0.0	0.0
Total Delay	6.1	7.5	17.3	28.2	36.2	22.5
Queue Length 50th (ft)	2	64	189	97	26	68
Queue Length 95th (ft)	9	154	#534	169	66	127
Internal Link Dist (ft)		316	315	398		435
Turn Bay Length (ft)	130				105	
Base Capacity (vph)	349	1153	1128	977	330	957
Starvation Cap Reductn	0	0	0	0	0	0
Spillback Cap Reductn	0	0	0	0	0	0
Storage Cap Reductn	0	0	0	0	0	0
Reduced v/c Ratio	0.04	0.40	0.80	0.33	0.26	0.27

Intersection Summary

95th percentile volume exceeds capacity, queue may be longer.
Queue shown is maximum after two cycles.



















HCM 2010 Signalized Intersection Summary
1: 4th St. & A St.

Existing Plus Project (PM)
02/26/2018

												
Movement	EBL	EBT	EBR	WBL	WBT	WBR	NBL	NBT	NBR	SBL	SBT	SBR
Lane Configurations												
Traffic Volume (veh/h)	11	1423	59	233	1141	7	87	7	264	39	23	15
Future Volume (veh/h)	11	1423	59	233	1141	7	87	7	264	39	23	15
Number	5	2	12	1	6	16	3	8	18	7	4	14
Initial Q (Qb), veh	0	0	0	0	0	0	0	0	0	0	0	0
Ped-Bike Adj(A_pbT)	1.00		0.97	1.00		0.98	1.00		1.00	1.00		0.98
Parking Bus, Adj	1.00	1.00	1.00	1.00	1.00	1.00	1.00	1.00	1.00	1.00	1.00	1.00
Adj Sat Flow, veh/h/ln	1881	1881	1900	1881	1881	1900	1900	1881	1881	1900	1881	1900
Adj Flow Rate, veh/h	11	1482	61	243	1189	7	91	7	275	41	24	16
Adj No. of Lanes	1	2	0	1	2	0	0	1	1	0	1	0
Peak Hour Factor	0.96	0.96	0.96	0.96	0.96	0.96	0.96	0.96	0.96	0.96	0.96	0.96
Percent Heavy Veh, %	1	1	1	1	1	1	1	1	1	1	1	1
Cap, veh/h	20	1646	68	289	2263	13	356	24	319	171	95	48
Arrive On Green	0.01	0.47	0.47	0.16	0.62	0.62	0.20	0.20	0.20	0.20	0.20	0.20
Sat Flow, veh/h	1792	3495	143	1792	3642	21	1316	121	1599	493	478	239
Grp Volume(v), veh/h	11	756	787	243	583	613	98	0	275	81	0	0
Grp Sat Flow(s),veh/h/ln	1792	1787	1851	1792	1787	1877	1437	0	1599	1210	0	0
Q Serve(g_s), s	0.5	28.8	29.1	9.8	13.6	13.6	0.0	0.0	12.4	1.3	0.0	0.0
Cycle Q Clear(g_c), s	0.5	28.8	29.1	9.8	13.6	13.6	4.1	0.0	12.4	5.4	0.0	0.0
Prop In Lane	1.00		0.08	1.00		0.01	0.93		1.00	0.51		0.20
Lane Grp Cap(c), veh/h	20	842	872	289	1110	1166	380	0	319	314	0	0
V/C Ratio(X)	0.56	0.90	0.90	0.84	0.53	0.53	0.26	0.00	0.86	0.26	0.00	0.00
Avail Cap(c_a), veh/h	241	842	872	603	1110	1166	590	0	559	517	0	0
HCM Platoon Ratio	1.00	1.00	1.00	1.00	1.00	1.00	1.00	1.00	1.00	1.00	1.00	1.00
Upstream Filter(I)	1.00	1.00	1.00	1.00	1.00	1.00	1.00	0.00	1.00	1.00	0.00	0.00
Uniform Delay (d), s/veh	36.6	18.0	18.1	30.2	7.9	7.9	25.4	0.0	28.8	25.6	0.0	0.0
Incr Delay (d2), s/veh	9.0	14.4	14.4	2.6	1.8	1.7	0.1	0.0	2.7	0.2	0.0	0.0
Initial Q Delay(d3),s/veh	0.0	0.0	0.0	0.0	0.0	0.0	0.0	0.0	0.0	0.0	0.0	0.0
%ile BackOfQ(50%),veh/ln	0.3	17.4	18.1	5.1	7.2	7.5	1.7	0.0	5.7	1.5	0.0	0.0
LnGrp Delay(d),s/veh	45.6	32.4	32.5	32.8	9.7	9.6	25.6	0.0	31.4	25.7	0.0	0.0
LnGrp LOS	D	C	C	C	A	A	C		C	C		
Approach Vol, veh/h		1554			1439			373				81
Approach Delay, s/veh		32.6			13.6			29.9				25.7
Approach LOS		C			B			C				C
Timer	1	2	3	4	5	6	7	8				
Assigned Phs	1	2		4	5	6		8				
Phs Duration (G+Y+Rc), s	16.0	39.5		18.8	4.8	50.7		18.8				
Change Period (Y+Rc), s	4.0	4.5		4.0	4.0	4.5		4.0				
Max Green Setting (Gmax), s	25.0	35.0		26.0	10.0	35.0		26.0				
Max Q Clear Time (g_c+I1), s	11.8	31.1		7.4	2.5	15.6		14.4				
Green Ext Time (p_c), s	0.3	3.1		0.2	0.0	8.2		0.5				
Intersection Summary												
HCM 2010 Ctrl Delay				24.2								
HCM 2010 LOS				C								
Notes												

HCM 2010 Signalized Intersection Summary
2: 4th St. & B St.

Existing Plus Project (PM)
02/26/2018

												
Movement	EBL	EBT	EBR	WBL	WBT	WBR	NBL	NBT	NBR	SBL	SBT	SBR
Lane Configurations												
Traffic Volume (veh/h)	62	548	11	19	515	117	7	177	60	84	186	34
Future Volume (veh/h)	62	548	11	19	515	117	7	177	60	84	186	34
Number	5	2	12	1	6	16	3	8	18	7	4	14
Initial Q (Qb), veh	0	0	0	0	0	0	0	0	0	0	0	0
Ped-Bike Adj(A_pbT)	1.00		0.97	1.00		0.97	1.00		1.00	1.00		0.97
Parking Bus, Adj	1.00	1.00	1.00	1.00	1.00	1.00	1.00	1.00	1.00	1.00	1.00	1.00
Adj Sat Flow, veh/h/ln	1881	1881	1900	1900	1881	1900	1900	1881	1900	1881	1881	1900
Adj Flow Rate, veh/h	67	589	12	20	554	126	8	190	65	90	200	37
Adj No. of Lanes	1	1	0	0	1	0	0	1	0	1	1	0
Peak Hour Factor	0.93	0.93	0.93	0.93	0.93	0.93	0.93	0.93	0.93	0.93	0.93	0.93
Percent Heavy Veh, %	1	1	1	1	1	1	1	1	1	1	1	1
Cap, veh/h	605	1098	22	101	865	192	94	275	92	421	320	59
Arrive On Green	0.60	0.60	0.60	0.60	0.60	0.60	0.21	0.21	0.21	0.21	0.21	0.21
Sat Flow, veh/h	763	1836	37	18	1447	322	22	1323	442	1129	1536	284
Grp Volume(v), veh/h	67	0	601	700	0	0	263	0	0	90	0	237
Grp Sat Flow(s),veh/h/ln	763	0	1873	1787	0	0	1787	0	0	1129	0	1821
Q Serve(g_s), s	0.0	0.0	7.8	0.0	0.0	0.0	0.5	0.0	0.0	0.0	0.0	4.9
Cycle Q Clear(g_c), s	1.9	0.0	7.8	10.5	0.0	0.0	5.6	0.0	0.0	2.6	0.0	4.9
Prop In Lane	1.00		0.02	0.03		0.18	0.03		0.25	1.00		0.16
Lane Grp Cap(c), veh/h	605	0	1120	1159	0	0	462	0	0	421	0	379
V/C Ratio(X)	0.11	0.00	0.54	0.60	0.00	0.00	0.57	0.00	0.00	0.21	0.00	0.63
Avail Cap(c_a), veh/h	796	0	1589	1596	0	0	1379	0	0	1007	0	1324
HCM Platoon Ratio	1.00	1.00	1.00	1.00	1.00	1.00	1.00	1.00	1.00	1.00	1.00	1.00
Upstream Filter(I)	1.00	0.00	1.00	1.00	0.00	0.00	1.00	0.00	0.00	1.00	0.00	1.00
Uniform Delay (d), s/veh	3.7	0.0	4.9	5.4	0.0	0.0	15.2	0.0	0.0	14.0	0.0	14.9
Incr Delay (d2), s/veh	0.4	0.0	1.8	1.1	0.0	0.0	0.4	0.0	0.0	0.1	0.0	0.6
Initial Q Delay(d3),s/veh	0.0	0.0	0.0	0.0	0.0	0.0	0.0	0.0	0.0	0.0	0.0	0.0
%ile BackOfQ(50%),veh/ln	0.4	0.0	4.4	5.4	0.0	0.0	2.8	0.0	0.0	0.9	0.0	2.5
LnGrp Delay(d),s/veh	4.1	0.0	6.8	6.5	0.0	0.0	15.6	0.0	0.0	14.1	0.0	15.5
LnGrp LOS	A		A	A			B			B		B
Approach Vol, veh/h		668			700			263				327
Approach Delay, s/veh		6.5			6.5			15.6				15.1
Approach LOS		A			A			B				B
Timer	1	2	3	4	5	6	7	8				
Assigned Phs		2		4		6		8				
Phs Duration (G+Y+Rc), s		28.7		12.6		28.7		12.6				
Change Period (Y+Rc), s		4.0		4.0		4.0		* 4				
Max Green Setting (Gmax), s		35.0		30.0		35.0		* 30				
Max Q Clear Time (g_c+I1), s		9.8		6.9		12.5		7.6				
Green Ext Time (p_c), s		14.8		1.1		9.5		1.0				
Intersection Summary												
HCM 2010 Ctrl Delay			9.2									
HCM 2010 LOS			A									
Notes												

HCM 2010 AWSC
3: 4th St. & C St.

Existing Plus Project (PM)
02/26/2018

Intersection	
Intersection Delay, s/veh	11.8
Intersection LOS	B

Movement	EBL	EBT	EBR	WBL	WBT	WBR	NBL	NBT	NBR	SBL	SBT	SBR
Lane Configurations		↕			↕			↕	↕		↕	
Traffic Vol, veh/h	80	180	39	11	19	33	4	151	16	25	167	17
Future Vol, veh/h	80	180	39	11	19	33	4	151	16	25	167	17
Peak Hour Factor	0.89	0.89	0.89	0.89	0.89	0.89	0.89	0.89	0.89	0.89	0.89	0.89
Heavy Vehicles, %	1	1	1	1	1	1	1	1	1	1	1	1
Mvmt Flow	90	202	44	12	21	37	4	170	18	28	188	19
Number of Lanes	0	1	0	0	1	0	0	1	1	0	1	0
Approach	EB			WB			NB			SB		
Opposing Approach	WB			EB			SB			NB		
Opposing Lanes	1			1			1			2		
Conflicting Approach Left	SB			NB			EB			WB		
Conflicting Lanes Left	1			2			1			1		
Conflicting Approach Right	NB			SB			WB			EB		
Conflicting Lanes Right	2			1			1			1		
HCM Control Delay	13.1			9.1			10.8			11.5		
HCM LOS	B			A			B			B		

Lane	NBLn1	NBLn2	EBLn1	WBLn1	SBLn1
Vol Left, %	3%	0%	27%	17%	12%
Vol Thru, %	97%	0%	60%	30%	80%
Vol Right, %	0%	100%	13%	52%	8%
Sign Control	Stop	Stop	Stop	Stop	Stop
Traffic Vol by Lane	155	16	299	63	209
LT Vol	4	0	80	11	25
Through Vol	151	0	180	19	167
RT Vol	0	16	39	33	17
Lane Flow Rate	174	18	336	71	235
Geometry Grp	7	7	2	2	5
Degree of Util (X)	0.289	0.026	0.486	0.106	0.355
Departure Headway (Hd)	5.974	5.251	5.203	5.401	5.441
Convergence, Y/N	Yes	Yes	Yes	Yes	Yes
Cap	601	681	692	662	662
Service Time	3.71	2.987	3.235	3.447	3.475
HCM Lane V/C Ratio	0.29	0.026	0.486	0.107	0.355
HCM Control Delay	11.1	8.1	13.1	9.1	11.5
HCM Lane LOS	B	A	B	A	B
HCM 95th-tile Q	1.2	0.1	2.7	0.4	1.6

Queues
1: 4th St. & A St.

Existing Plus Project (PM)
02/26/2018

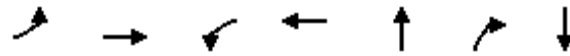

Lane Group	EBL	EBT	WBL	WBT	NBT	NBR	SBT
Lane Group Flow (vph)	11	1543	243	1196	98	275	81
v/c Ratio	0.10	0.90	0.70	0.47	0.49	0.59	0.36
Control Delay	40.5	28.7	40.1	7.4	37.5	9.3	29.4
Queue Delay	0.0	0.0	0.0	0.0	0.0	0.0	0.0
Total Delay	40.5	28.7	40.1	7.4	37.5	9.3	29.4
Queue Length 50th (ft)	5	291	99	75	41	0	28
Queue Length 95th (ft)	25	#772	213	327	92	60	71
Internal Link Dist (ft)		360		531	435		156
Turn Bay Length (ft)	72		110			105	
Base Capacity (vph)	247	1721	618	2580	496	754	540
Starvation Cap Reductn	0	0	0	0	0	0	0
Spillback Cap Reductn	0	0	0	0	0	0	0
Storage Cap Reductn	0	0	0	0	0	0	0
Reduced v/c Ratio	0.04	0.90	0.39	0.46	0.20	0.36	0.15

Intersection Summary

95th percentile volume exceeds capacity, queue may be longer.
Queue shown is maximum after two cycles.

Queues
2: 4th St. & B St.

Existing Plus Project (PM)
02/26/2018

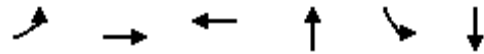

Lane Group	EBL	EBT	WBT	NBT	SBL	SBT
Lane Group Flow (vph)	67	601	700	263	90	237
v/c Ratio	0.17	0.57	0.68	0.52	0.41	0.52
Control Delay	6.7	9.3	11.5	17.4	21.8	19.0
Queue Delay	0.0	0.0	0.0	0.0	0.0	0.0
Total Delay	6.7	9.3	11.5	17.4	21.8	19.0
Queue Length 50th (ft)	7	78	98	45	17	44
Queue Length 95th (ft)	28	211	274	126	61	120
Internal Link Dist (ft)		316	315	398		435
Turn Bay Length (ft)	130				105	
Base Capacity (vph)	568	1492	1431	1319	631	1296
Starvation Cap Reductn	0	0	0	0	0	0
Spillback Cap Reductn	0	0	0	0	0	0
Storage Cap Reductn	0	0	0	0	0	0
Reduced v/c Ratio	0.12	0.40	0.49	0.20	0.14	0.18
Intersection Summary						

Attachment D: Intersection Signal Warrant Sheets (4th Street & C Street)



KITTELSON & ASSOCIATES, INC.
 610 SW Alder, Suite 700
 Portland, Oregon 97205
 (503) 228-5230

Analysis Traffic Volumes

Hour	Major Street		Minor Street			
	Begin	End	EB	WB	NB	SB
7:40 AM	8:40 AM		170	122	282	206
2nd Highest Hour			161	115	267	195
3rd Highest Hour			159	114	263	192
4th Highest Hour			152	109	252	184
5th Highest Hour			150	107	248	181
6th Highest Hour			150	107	248	181
7th Highest Hour			143	102	237	173
8th Highest Hour			141	101	233	170
9th Highest Hour			136	98	226	165
10th Highest Hour			127	91	211	154
11th Highest Hour			122	88	203	148
12th Highest Hour			120	86	199	146
13th Highest Hour			116	83	192	140
14th Highest Hour			100	72	165	121
15th Highest Hour			79	57	132	96
16th Highest Hour			75	54	124	91
17th Highest Hour			52	37	86	63
18th Highest Hour			43	31	71	52
19th Highest Hour			23	16	38	27
20th Highest Hour			16	11	26	19
21st Highest Hour			14	10	23	16
22nd Highest Hour			9	7	15	11
23rd Highest Hour			5	3	8	5
24th Highest Hour			5	3	8	5

Project #: 22304
Project Name: Hayward/B St. Residential
Analyst: MZS
Date: 3/1/2018
File: H:\22\22304 - Hayward B Street Residential
 EIR\Analysis\Signal Warrants\22304_Signal Warrant
 Analysis Existing AM 022718.xls\Warrant
Intersection: 4th St./C St.
Scenario: Existing AM

Warrant Summary

Warrant	Name	Analyzed?	Met?
#1	Eight-Hour Vehicular Volume	Yes	No
#2	Four-Hour Vehicular volume	Yes	No
#3	Peak Hour	Yes	No
#4	Pedestrian Volume	Yes	No
#5	School Crossing	No	-
#6	Coordinated Signal System	No	-
#7	Crash Experience	No	-
#8	Roadway Network	No	-
#9	Intersection Near a Grade Crossing	No	-

Input Parameters

Volume Adjustment Factor =	1.0
North-South Approach =	Minor
East-West Approach =	Major
Major Street Thru Lanes =	1
Minor Street Thru Lanes =	1
Speed > 40 mph?	No
Population < 10,000?	No
Warrant Factor	100%
Peak Hour or Daily Count?	Peak Hour
Major Street: 4th-Highest Hour / Peak Hour	89%
Major Street: 8th-Highest Hour / Peak Hour	83%
Minor Street: 4th-Highest Hour / Peak Hour	89%
Minor Street: 8th-Highest Hour / Peak Hour	83%

Warrant #1 - Eight Hour

Warrant Factor	Condition	Major Street Requirement	Minor Street Requirement	Hours That Condition Is Met	Condition for Warrant Factor Met?	Signal Warrant Met?
100%	A	500	150	0	No	No
	B	750	75	0	No	No
80%	A	400	120	0	No	No
	B	600	60	0	No	No
70%	A	350	105	0	No	No
	B	525	53	0	No	No
56%	A	280	84	1	No	No
	B	420	42	0	No	No

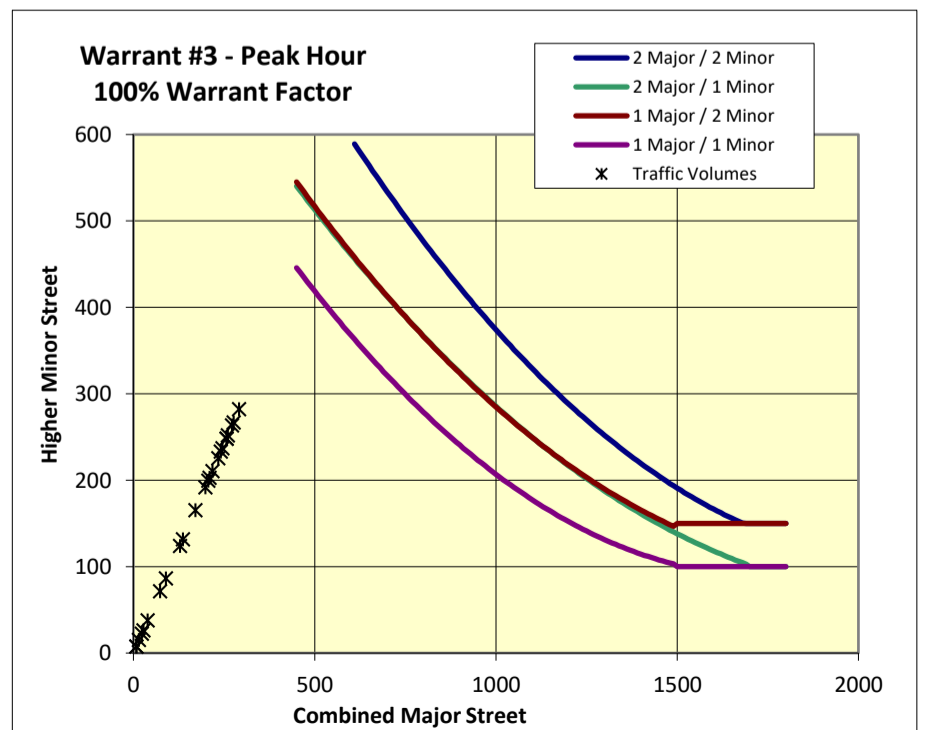
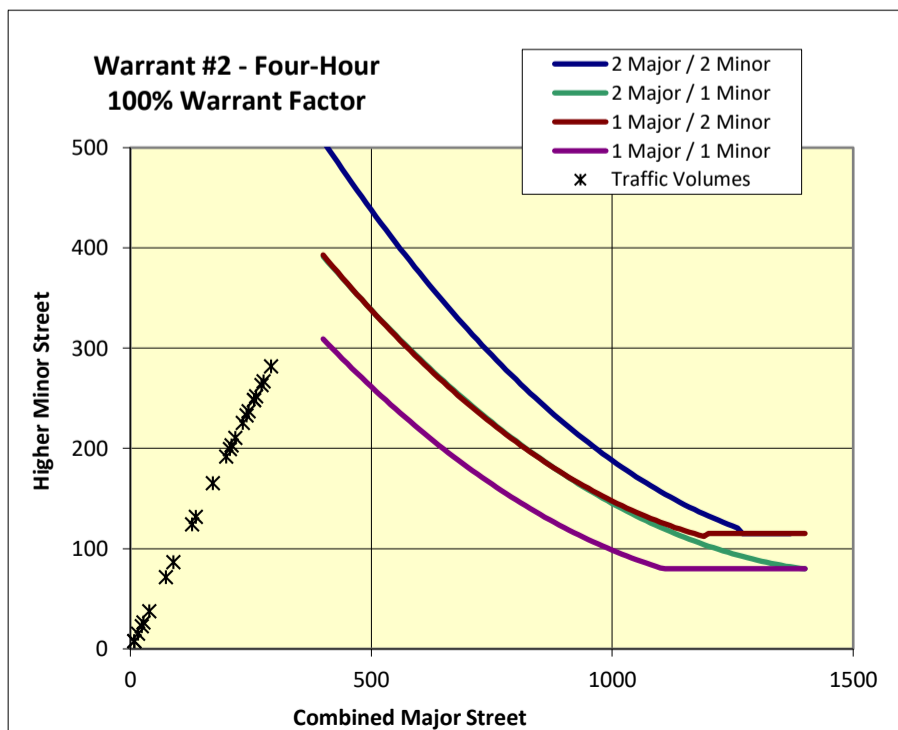



KITTELSON & ASSOCIATES, INC.
 610 SW Alder, Suite 700
 Portland, Oregon 97205
 (503) 228-5230

Project #: 22304
Project Name: Hayward/B St. Residential
Analyst: MZS
Date: 3/1/2018
File: H:\22\22304 - Hayward B Street Residential
 EIR\Analysis\Signal Warrants\22304_Signal Warrant
 Analysis Existing AM 022718.xls\Warrant
Intersection: 4th St./C St.
Scenario: Existing PM

Analysis Traffic Volumes

Hour	Major Street		Minor Street			
	Begin	End	EB	WB	NB	SB
4:00 PM	5:00 PM		297	63	165	204
2nd Highest Hour			281	60	156	193
3rd Highest Hour			277	59	154	190
4th Highest Hour			265	56	147	182
5th Highest Hour			261	55	145	180
6th Highest Hour			261	55	145	180
7th Highest Hour			249	53	139	171
8th Highest Hour			246	52	136	169
9th Highest Hour			238	50	132	163
10th Highest Hour			222	47	123	152
11th Highest Hour			214	45	119	147
12th Highest Hour			210	45	117	144
13th Highest Hour			202	43	112	139
14th Highest Hour			174	37	97	120
15th Highest Hour			139	29	77	95
16th Highest Hour			131	28	73	90
17th Highest Hour			91	19	51	63
18th Highest Hour			75	16	42	52
19th Highest Hour			40	8	22	27
20th Highest Hour			28	6	15	19
21st Highest Hour			24	5	13	16
22nd Highest Hour			16	3	9	11
23rd Highest Hour			8	2	4	5
24th Highest Hour			8	2	4	5

Warrant Summary

Warrant	Name	Analyzed?	Met?
#1	Eight-Hour Vehicular Volume	Yes	No
#2	Four-Hour Vehicular volume	Yes	No
#3	Peak Hour	Yes	No
#4	Pedestrian Volume	Yes	No
#5	School Crossing	No	-
#6	Coordinated Signal System	No	-
#7	Crash Experience	No	-
#8	Roadway Network	No	-
#9	Intersection Near a Grade Crossing	No	-

Input Parameters

Volume Adjustment Factor =	1.0
North-South Approach =	Minor
East-West Approach =	Major
Major Street Thru Lanes =	1
Minor Street Thru Lanes =	1
Speed > 40 mph?	No
Population < 10,000?	No
Warrant Factor	100%
Peak Hour or Daily Count?	Peak Hour
Major Street: 4th-Highest Hour / Peak Hour	89%
Major Street: 8th-Highest Hour / Peak Hour	83%
Minor Street: 4th-Highest Hour / Peak Hour	89%
Minor Street: 8th-Highest Hour / Peak Hour	83%

Warrant #1 - Eight Hour

Warrant Factor	Condition	Major Street Requirement	Minor Street Requirement	Hours That Condition Is Met	Condition for Warrant Factor Met?	Signal Warrant Met?
100%	A	500	150	0	No	No
	B	750	75	0	No	No
80%	A	400	120	0	No	No
	B	600	60	0	No	No
70%	A	350	105	1	No	No
	B	525	53	0	No	No
56%	A	280	84	9	Yes	Yes
	B	420	42	0	No	Yes

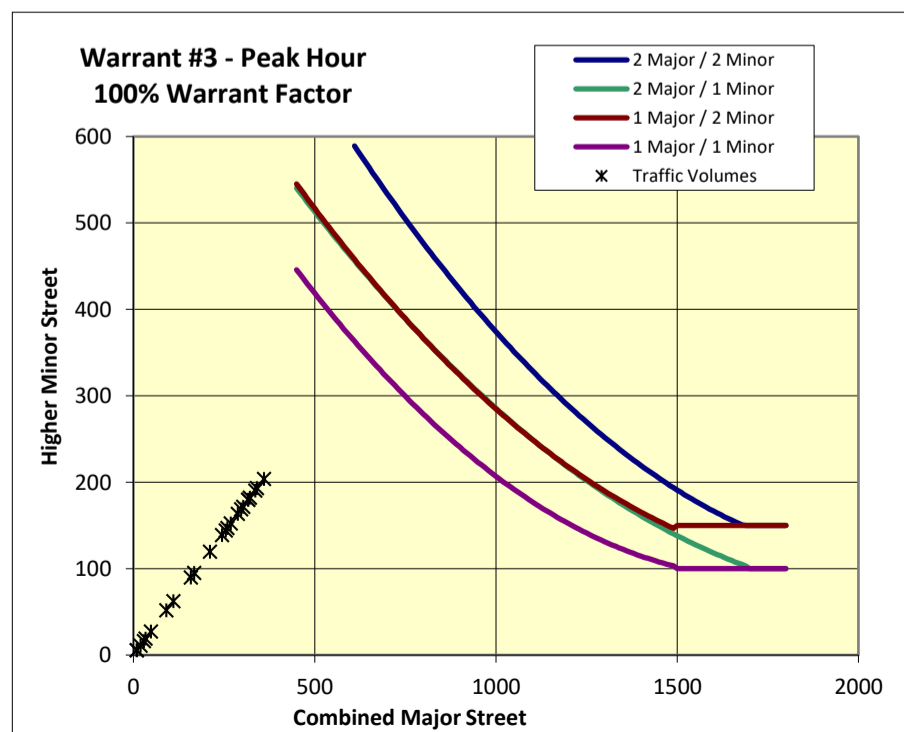
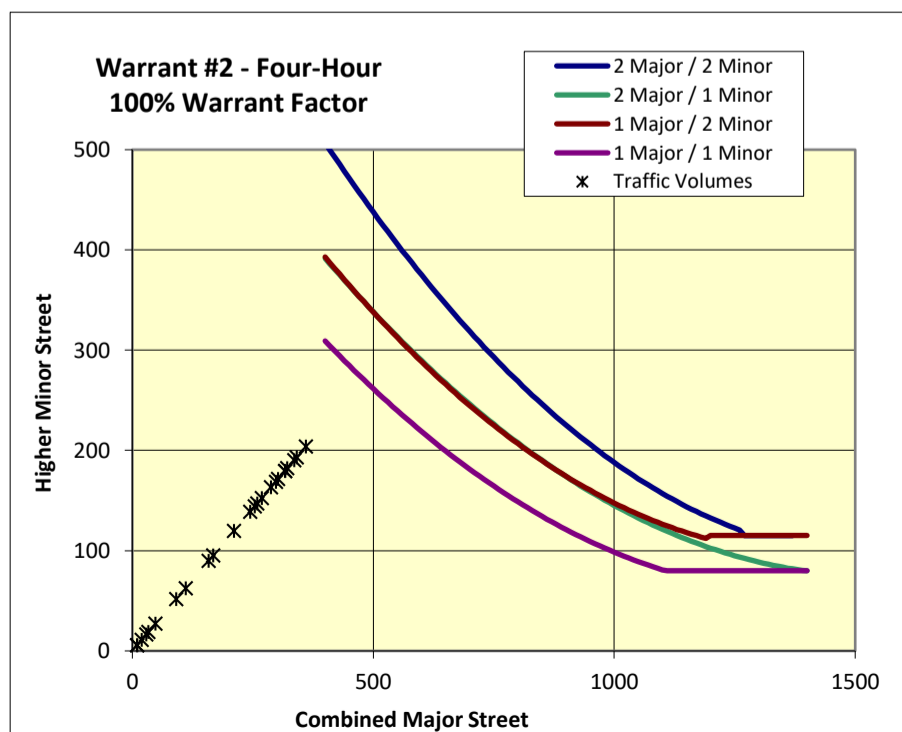



KITTELSON & ASSOCIATES, INC.
 610 SW Alder, Suite 700
 Portland, Oregon 97205
 (503) 228-5230

Analysis Traffic Volumes

Hour	Major Street		Minor Street			
	Begin	End	EB	WB	NB	SB
7:40 AM	8:40 AM		171	122	284	213
2nd Highest Hour			162	115	269	202
3rd Highest Hour			160	114	265	199
4th Highest Hour			153	109	254	190
5th Highest Hour			150	107	250	187
6th Highest Hour			150	107	250	187
7th Highest Hour			144	102	239	179
8th Highest Hour			141	101	235	176
9th Highest Hour			137	98	227	170
10th Highest Hour			128	91	212	159
11th Highest Hour			123	88	204	153
12th Highest Hour			121	86	201	151
13th Highest Hour			116	83	193	145
14th Highest Hour			100	72	167	125
15th Highest Hour			80	57	133	99
16th Highest Hour			75	54	125	94
17th Highest Hour			52	37	87	65
18th Highest Hour			43	31	72	54
19th Highest Hour			23	16	38	28
20th Highest Hour			16	11	27	20
21st Highest Hour			14	10	23	17
22nd Highest Hour			9	7	15	11
23rd Highest Hour			5	3	8	6
24th Highest Hour			5	3	8	6

Project #: 22304
Project Name: Hayward/B St. Residential
Analyst: MZS
Date: 3/1/2018
File: H:\22\22304 - Hayward B Street Residential
 EIR\Analysis\Signal Warrants\22304_Signal Warrant
 Analysis Existing AM 022718.xls\Warrant
Intersection: 4th St./C St.
Scenario: Existing Plus Project AM

Warrant Summary

Warrant	Name	Analyzed?	Met?
#1	Eight-Hour Vehicular Volume	Yes	No
#2	Four-Hour Vehicular volume	Yes	No
#3	Peak Hour	Yes	No
#4	Pedestrian Volume	Yes	No
#5	School Crossing	No	-
#6	Coordinated Signal System	No	-
#7	Crash Experience	No	-
#8	Roadway Network	No	-
#9	Intersection Near a Grade Crossing	No	-

Input Parameters

Volume Adjustment Factor =	1.0
North-South Approach =	Minor
East-West Approach =	Major
Major Street Thru Lanes =	1
Minor Street Thru Lanes =	1
Speed > 40 mph?	No
Population < 10,000?	No
Warrant Factor	100%
Peak Hour or Daily Count?	Peak Hour
Major Street: 4th-Highest Hour / Peak Hour	89%
Major Street: 8th-Highest Hour / Peak Hour	83%
Minor Street: 4th-Highest Hour / Peak Hour	89%
Minor Street: 8th-Highest Hour / Peak Hour	83%

Warrant #1 - Eight Hour

Warrant Factor	Condition	Major Street Requirement	Minor Street Requirement	Hours That Condition Is Met	Condition for Warrant Factor Met?	Signal Warrant Met?
100%	A	500	150	0	No	No
	B	750	75	0	No	No
80%	A	400	120	0	No	No
	B	600	60	0	No	No
70%	A	350	105	0	No	No
	B	525	53	0	No	No
56%	A	280	84	1	No	No
	B	420	42	0	No	No

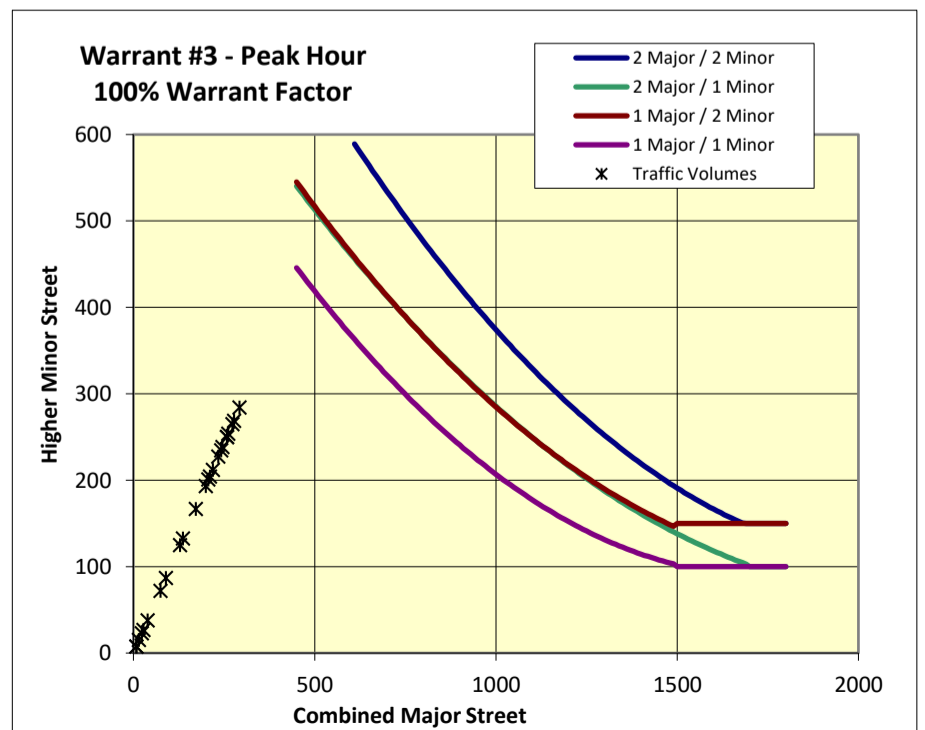
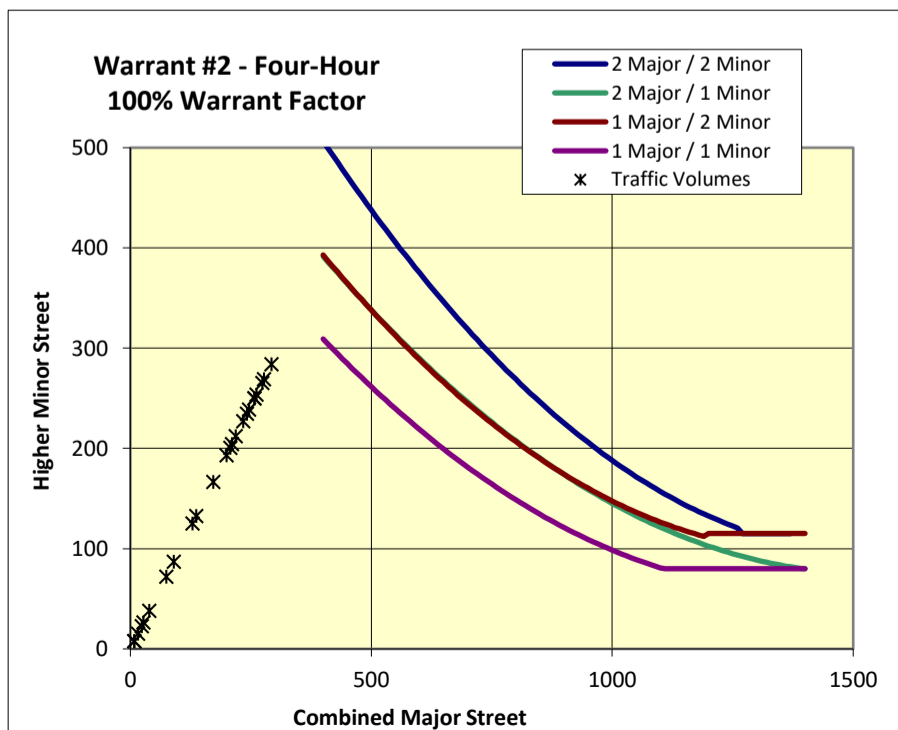



KITTELSON & ASSOCIATES, INC.
 610 SW Alder, Suite 700
 Portland, Oregon 97205
 (503) 228-5230

Project #: 22304
Project Name: Hayward/B St. Residential
Analyst: MZS
Date: 3/1/2018
File: H:\22\22304 - Hayward B Street Residential
 EIR\Analysis\Signal Warrants\22304_Signal Warrant
 Analysis Existing AM 022718.xls\Warrant
Intersection: 4th St./C St.
Scenario: Existing Plus Project PM

Analysis Traffic Volumes

Hour	Major Street		Minor Street			
	Begin	End	EB	WB	NB	SB
4:00 PM	5:00 PM		299	63	171	209
2nd Highest Hour			283	60	162	198
3rd Highest Hour			279	59	160	195
4th Highest Hour			267	56	153	187
5th Highest Hour			263	55	150	184
6th Highest Hour			263	55	150	184
7th Highest Hour			251	53	144	176
8th Highest Hour			247	52	141	173
9th Highest Hour			239	50	137	167
10th Highest Hour			223	47	128	156
11th Highest Hour			215	45	123	150
12th Highest Hour			211	45	121	148
13th Highest Hour			203	43	116	142
14th Highest Hour			175	37	100	123
15th Highest Hour			140	29	80	98
16th Highest Hour			132	28	75	92
17th Highest Hour			92	19	52	64
18th Highest Hour			76	16	43	53
19th Highest Hour			40	8	23	28
20th Highest Hour			28	6	16	20
21st Highest Hour			24	5	14	17
22nd Highest Hour			16	3	9	11
23rd Highest Hour			8	2	5	6
24th Highest Hour			8	2	5	6

Warrant Summary

Warrant	Name	Analyzed?	Met?
#1	Eight-Hour Vehicular Volume	Yes	No
#2	Four-Hour Vehicular volume	Yes	No
#3	Peak Hour	Yes	No
#4	Pedestrian Volume	Yes	No
#5	School Crossing	No	-
#6	Coordinated Signal System	No	-
#7	Crash Experience	No	-
#8	Roadway Network	No	-
#9	Intersection Near a Grade Crossing	No	-

Input Parameters

Volume Adjustment Factor =	1.0
North-South Approach =	Minor
East-West Approach =	Major
Major Street Thru Lanes =	1
Minor Street Thru Lanes =	1
Speed > 40 mph?	No
Population < 10,000?	No
Warrant Factor	100%
Peak Hour or Daily Count?	Peak Hour
Major Street: 4th-Highest Hour / Peak Hour	89%
Major Street: 8th-Highest Hour / Peak Hour	83%
Minor Street: 4th-Highest Hour / Peak Hour	89%
Minor Street: 8th-Highest Hour / Peak Hour	83%

Warrant #1 - Eight Hour



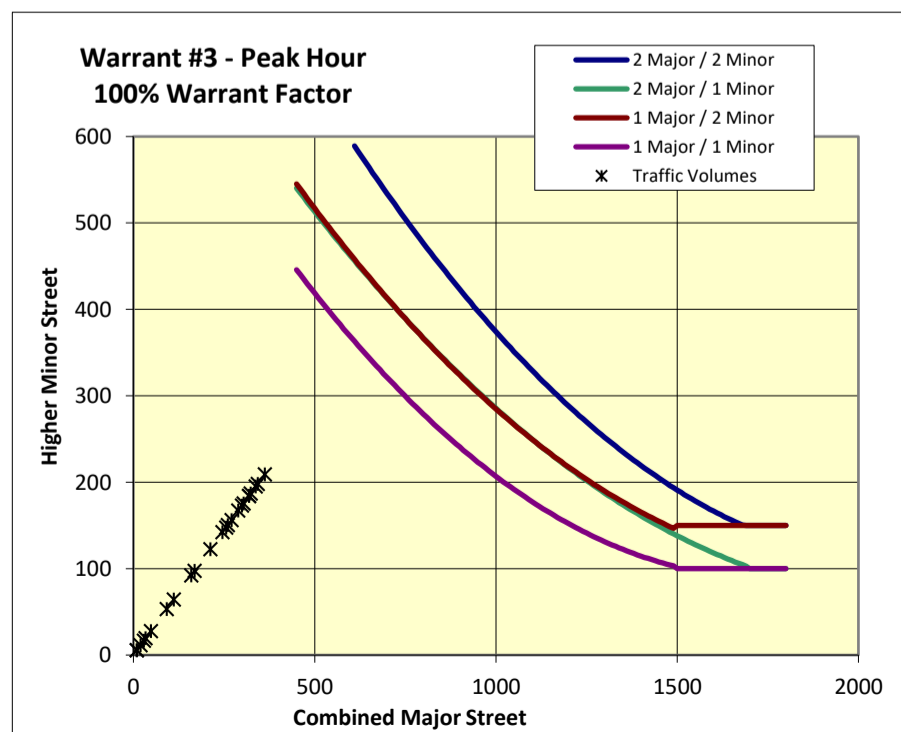
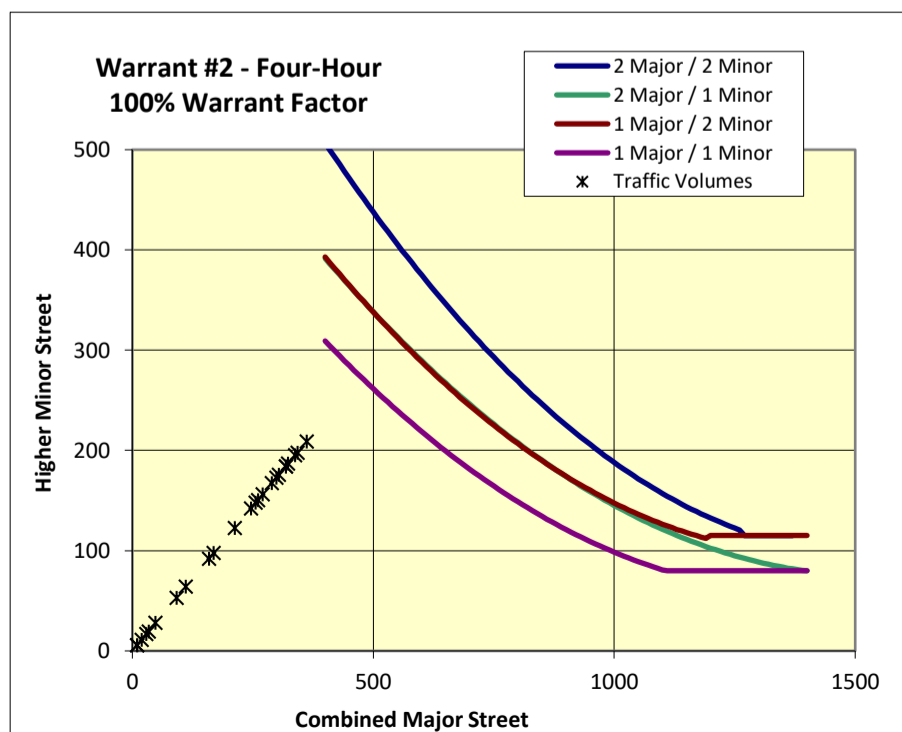















Warrant Factor	Condition	Major Street Requirement	Minor Street Requirement	Hours That Condition Is Met	Condition for Warrant Factor Met?	Signal Warrant Met?
100%	A	500	150	0	No	No
	B	750	75	0	No	No
80%	A	400	120	0	No	No
	B	600	60	0	No	No
70%	A	350	105	1	No	No
	B	525	53	0	No	No
56%	A	280	84	9	Yes	Yes
	B	420	42	0	No	No



Attachment E: 4th Street & B Street Westbound Left Turn Synchro
Output Sheets



















HCM 2010 Signalized Intersection Summary
2: 4th St. & B St.

Mitigated (AM)
03/13/2018

												
Movement	EBL	EBT	EBR	WBL	WBT	WBR	NBL	NBT	NBR	SBL	SBT	SBR
Lane Configurations												
Traffic Volume (veh/h)	13	412	15	20	734	87	26	250	28	80	178	64
Future Volume (veh/h)	13	412	15	20	734	87	26	250	28	80	178	64
Number	5	2	12	1	6	16	3	8	18	7	4	14
Initial Q (Qb), veh	0	0	0	0	0	0	0	0	0	0	0	0
Ped-Bike Adj(A_pbT)	1.00		0.99	1.00		0.97	0.99		0.99	0.99		0.99
Parking Bus, Adj	1.00	1.00	1.00	1.00	1.00	1.00	1.00	1.00	1.00	1.00	1.00	1.00
Adj Sat Flow, veh/h/ln	1863	1863	1900	1863	1863	1900	1900	1863	1900	1863	1863	1900
Adj Flow Rate, veh/h	14	443	16	22	789	94	28	269	30	86	191	69
Adj No. of Lanes	1	1	0	1	1	0	0	1	0	1	1	0
Peak Hour Factor	0.93	0.93	0.93	0.93	0.93	0.93	0.93	0.93	0.93	0.93	0.93	0.93
Percent Heavy Veh, %	2	2	2	2	2	2	2	2	2	2	2	2
Cap, veh/h	270	1057	38	563	963	115	94	372	39	357	329	119
Arrive On Green	0.59	0.59	0.59	0.59	0.59	0.59	0.25	0.25	0.25	0.25	0.25	0.25
Sat Flow, veh/h	626	1786	65	927	1628	194	73	1471	156	1070	1303	471
Grp Volume(v), veh/h	14	0	459	22	0	883	327	0	0	86	0	260
Grp Sat Flow(s),veh/h/ln	626	0	1851	927	0	1822	1700	0	0	1070	0	1773
Q Serve(g_s), s	0.9	0.0	6.9	0.7	0.0	19.8	2.6	0.0	0.0	0.0	0.0	6.6
Cycle Q Clear(g_c), s	20.7	0.0	6.9	7.6	0.0	19.8	9.2	0.0	0.0	4.8	0.0	6.6
Prop In Lane	1.00		0.03	1.00		0.11	0.09		0.09	1.00		0.27
Lane Grp Cap(c), veh/h	270	0	1095	563	0	1078	506	0	0	357	0	448
V/C Ratio(X)	0.05	0.00	0.42	0.04	0.00	0.82	0.65	0.00	0.00	0.24	0.00	0.58
Avail Cap(c_a), veh/h	325	0	1259	646	0	1239	1078	0	0	711	0	1034
HCM Platoon Ratio	1.00	1.00	1.00	1.00	1.00	1.00	1.00	1.00	1.00	1.00	1.00	1.00
Upstream Filter(I)	1.00	0.00	1.00	1.00	0.00	1.00	1.00	0.00	0.00	1.00	0.00	1.00
Uniform Delay (d), s/veh	16.5	0.0	5.7	7.8	0.0	8.3	17.6	0.0	0.0	16.2	0.0	16.8
Incr Delay (d2), s/veh	0.4	0.0	1.2	0.1	0.0	4.9	0.5	0.0	0.0	0.1	0.0	0.4
Initial Q Delay(d3),s/veh	0.0	0.0	0.0	0.0	0.0	0.0	0.0	0.0	0.0	0.0	0.0	0.0
%ile BackOfQ(50%),veh/ln	0.2	0.0	3.8	0.2	0.0	11.3	4.3	0.0	0.0	1.0	0.0	3.2
LnGrp Delay(d),s/veh	16.9	0.0	6.9	7.8	0.0	13.3	18.2	0.0	0.0	16.3	0.0	17.3
LnGrp LOS	B		A	A		B	B			B		B
Approach Vol, veh/h		473			905			327				346
Approach Delay, s/veh		7.2			13.1			18.2				17.0
Approach LOS		A			B			B				B
Timer	1	2	3	4	5	6	7	8				
Assigned Phs		2		4		6		8				
Phs Duration (G+Y+Rc), s		34.4		17.0		34.4		17.0				
Change Period (Y+Rc), s		4.0		4.0		4.0		* 4				
Max Green Setting (Gmax), s		35.0		30.0		35.0		* 30				
Max Q Clear Time (g_c+I1), s		22.7		8.6		21.8		11.2				
Green Ext Time (p_c), s		6.4		1.2		8.7		1.2				
Intersection Summary												
HCM 2010 Ctrl Delay				13.2								
HCM 2010 LOS				B								
Notes												

HCM 2010 Signalized Intersection Summary
2: 4th St. & B St.

Mitigated (PM)
03/13/2018

												
Movement	EBL	EBT	EBR	WBL	WBT	WBR	NBL	NBT	NBR	SBL	SBT	SBR
Lane Configurations												
Traffic Volume (veh/h)	62	548	11	19	515	117	7	177	60	84	186	34
Future Volume (veh/h)	62	548	11	19	515	117	7	177	60	84	186	34
Number	5	2	12	1	6	16	3	8	18	7	4	14
Initial Q (Qb), veh	0	0	0	0	0	0	0	0	0	0	0	0
Ped-Bike Adj(A_pbT)	1.00		0.97	1.00		0.97	1.00		1.00	1.00		0.97
Parking Bus, Adj	1.00	1.00	1.00	1.00	1.00	1.00	1.00	1.00	1.00	1.00	1.00	1.00
Adj Sat Flow, veh/h/ln	1881	1881	1900	1881	1881	1900	1900	1881	1900	1881	1881	1900
Adj Flow Rate, veh/h	67	589	12	20	554	126	8	190	65	90	200	37
Adj No. of Lanes	1	1	0	1	1	0	0	1	0	1	1	0
Peak Hour Factor	0.93	0.93	0.93	0.93	0.93	0.93	0.93	0.93	0.93	0.93	0.93	0.93
Percent Heavy Veh, %	1	1	1	1	1	1	1	1	1	1	1	1
Cap, veh/h	454	1130	23	517	907	206	87	272	91	392	316	58
Arrive On Green	0.62	0.62	0.62	0.62	0.62	0.62	0.21	0.21	0.21	0.21	0.21	0.21
Sat Flow, veh/h	763	1836	37	820	1473	335	22	1325	442	1130	1537	284
Grp Volume(v), veh/h	67	0	601	20	0	680	263	0	0	90	0	237
Grp Sat Flow(s),veh/h/ln	763	0	1873	820	0	1809	1788	0	0	1130	0	1821
Q Serve(g_s), s	2.7	0.0	8.1	0.6	0.0	10.4	0.6	0.0	0.0	0.0	0.0	5.3
Cycle Q Clear(g_c), s	13.0	0.0	8.1	8.8	0.0	10.4	6.1	0.0	0.0	3.1	0.0	5.3
Prop In Lane	1.00		0.02	1.00		0.19	0.03		0.25	1.00		0.16
Lane Grp Cap(c), veh/h	454	0	1153	517	0	1113	451	0	0	392	0	374
V/C Ratio(X)	0.15	0.00	0.52	0.04	0.00	0.61	0.58	0.00	0.00	0.23	0.00	0.63
Avail Cap(c_a), veh/h	581	0	1465	653	0	1414	1272	0	0	917	0	1221
HCM Platoon Ratio	1.00	1.00	1.00	1.00	1.00	1.00	1.00	1.00	1.00	1.00	1.00	1.00
Upstream Filter(l)	1.00	0.00	1.00	1.00	0.00	1.00	1.00	0.00	0.00	1.00	0.00	1.00
Uniform Delay (d), s/veh	9.3	0.0	4.9	7.3	0.0	5.3	16.5	0.0	0.0	15.4	0.0	16.2
Incr Delay (d2), s/veh	0.7	0.0	1.7	0.1	0.0	1.2	0.4	0.0	0.0	0.1	0.0	0.7
Initial Q Delay(d3),s/veh	0.0	0.0	0.0	0.0	0.0	0.0	0.0	0.0	0.0	0.0	0.0	0.0
%ile BackOfQ(50%),veh/ln	0.6	0.0	4.7	0.2	0.0	5.5	3.1	0.0	0.0	1.0	0.0	2.7
LnGrp Delay(d),s/veh	10.0	0.0	6.6	7.4	0.0	6.5	17.0	0.0	0.0	15.5	0.0	16.9
LnGrp LOS	A		A	A		A	B			B		B
Approach Vol, veh/h		668			700			263				327
Approach Delay, s/veh		6.9			6.5			17.0				16.5
Approach LOS		A			A			B				B
Timer	1	2	3	4	5	6	7	8				
Assigned Phs		2		4		6		8				
Phs Duration (G+Y+Rc), s		31.6		13.2		31.6		13.2				
Change Period (Y+Rc), s		4.0		4.0		4.0		* 4				
Max Green Setting (Gmax), s		35.0		30.0		35.0		* 30				
Max Q Clear Time (g_c+I1), s		15.0		7.3		12.4		8.1				
Green Ext Time (p_c), s		12.5		1.1		9.3		1.0				
Intersection Summary												
HCM 2010 Ctrl Delay			9.7									
HCM 2010 LOS			A									
Notes												

Queues
2: 4th St. & B St.

Mitigated (PM)
03/13/2018

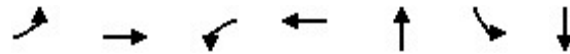

Lane Group	EBL	EBT	WBL	WBT	NBT	SBL	SBT
Lane Group Flow (vph)	67	601	20	680	263	90	237
v/c Ratio	0.22	0.57	0.06	0.66	0.52	0.40	0.51
Control Delay	8.1	9.4	5.9	10.9	17.0	21.0	18.5
Queue Delay	0.0	0.0	0.0	0.0	0.0	0.0	0.0
Total Delay	8.1	9.4	5.9	10.9	17.0	21.0	18.5
Queue Length 50th (ft)	7	76	2	90	42	16	41
Queue Length 95th (ft)	31	211	11	255	126	61	120
Internal Link Dist (ft)		316		315	398		435
Turn Bay Length (ft)	130		100			105	
Base Capacity (vph)	431	1520	515	1479	1334	652	1319
Starvation Cap Reductn	0	0	0	0	0	0	0
Spillback Cap Reductn	0	0	0	0	0	0	0
Storage Cap Reductn	0	0	0	0	0	0	0
Reduced v/c Ratio	0.16	0.40	0.04	0.46	0.20	0.14	0.18
Intersection Summary							

Queues
2: 4th St. & B St.

Mitigated (AM)
03/13/2018

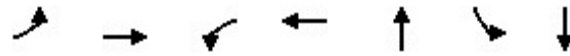

Lane Group	EBL	EBT	WBL	WBT	NBT	SBL	SBT
Lane Group Flow (vph)	14	459	22	883	327	86	260
v/c Ratio	0.07	0.40	0.04	0.78	0.72	0.59	0.59
Control Delay	6.9	7.6	6.0	15.9	28.1	36.0	22.3
Queue Delay	0.0	0.0	0.0	0.0	0.0	0.0	0.0
Total Delay	6.9	7.6	6.0	15.9	28.1	36.0	22.3
Queue Length 50th (ft)	2	64	2	179	97	26	68
Queue Length 95th (ft)	10	155	12	#510	170	66	127
Internal Link Dist (ft)		316		315	398		435
Turn Bay Length (ft)	130		100			105	
Base Capacity (vph)	207	1156	523	1144	978	331	962
Starvation Cap Reductn	0	0	0	0	0	0	0
Spillback Cap Reductn	0	0	0	0	0	0	0
Storage Cap Reductn	0	0	0	0	0	0	0
Reduced v/c Ratio	0.07	0.40	0.04	0.77	0.33	0.26	0.27

Intersection Summary

95th percentile volume exceeds capacity, queue may be longer.
Queue shown is maximum after two cycles.

Attachment F: Signal Timing Sheets

Configuration

	Controller Sequence Priority											
	1	2	3	4	5	6	7	8	9	10	11	12
Ring 1 Phases . .	1	2	3	4	9	10	0	0	0	0	0	0
Ring 2 Phases . .	5	6	7	8	11	12	0	0	0	0	0	0
	Phase											
	1	2	3	4	5	6	7	8	9	10	11	12
In Use.	X	X	.	X	X	X	.	X
Exclusive Ped
Direction												
	Overlap											
Direction	A	B	C	D								

Load Switch Channel/Driver Group Assign (Info Only):

Load Switch Channel (MMU)	Driver Phase/Ovlap	Signal Group Ped
1	1	.
2	2	.
3	3	.
4	4	.
5	5	.
6	6	.
7	7	.
8	8	.
9	9	X
10	10	X
11	11	X
12	12	X
13	A	.
14	B	.
15	C	.
16	D	.

Configuration Continued

Event Enabling

Alarm Enabling

Critical RFE'S (MMU/TF)	ALARM 1
Non-Critical RFE'S (DET/TEST)	ALARM 2
Detector Errors	ALARM 3
Coordination Errors	ALARM 4
MMU Flash Faults	ALARM 5
Local Flash Faults	ALARM 6
Preempt	ALARM 7
Power On/Off	ALARM 8
Low Battery	ALARM 9
	ALARM 10
	ALARM 11
	ALARM 12
	ALARM 13
	ALARM 14
	ALARM 15
	ALARM 16

Supervisor Access Code . . . ****
 Data Change Access Code . . . ****

MMU Compatibility Program (Info Only)

Channel	Is Allowed to Time With Channel														
	16	15	14	13	12	11	10	9	8	7	6	5	4	3	2
1
2
3
4
5
6
7
8
9
10
11
12
13
14
15

Version Info:		
Software Assy.	Part No.	Version
Boot	27831	2.83
Program	45561	7.2
Application		. 3
Help	27891	5.83
Configuration	27918	C000

By-Phase Timing Data

Direction	Phase											
	1	2	3	4	5	6	7	8	9	10	11	12
Minimum Green	4	8	0	4	4	8	0	4	5	5	5	5
Bike Min Green	0	0	0	0	0	0	0	0	0	0	0	0
Cond Serv Min Grn	0	0	0	0	0	0	0	0	0	0	0	0
Walk	0	7	0	7	0	7	0	7	0	10	0	10
Ped Clearance	0	16	0	20	0	16	0	20	0	16	0	16
Veh Extension	2.0	3.0	0.0	1.5	1.5	3.0	0.0	1.5	5.0	5.0	5.0	5.0
Alt Veh Exten	0.0	0.0	0.0	0.0	0.0	0.0	0.0	0.0	0.0	0.0	0.0	0.0
Max Extension	0	0	0	0	0	0	0	0	0	0	0	0
Max 1	25	35	0	26	10	35	0	26	35	35	35	35
Max 2	25	55	0	28	15	55	0	28	40	40	40	40
Max 3	25	55	0	28	20	50	0	28	0	0	0	0
Det. Fail Max	0	0	0	0	0	0	0	0	0	0	0	0
Yellow Change	3.0	3.5	3.0	3.0	3.0	3.5	3.0	3.0	3.0	3.0	3.0	3.0
Red Clearance	1.0	1.0	1.0	1.0	1.0	1.0	1.0	1.0	1.0	1.0	1.0	1.0
Red Revert	2.0	2.0	2.0	2.0	2.0	2.0	2.0	2.0	2.0	2.0	2.0	2.0
Act. B4 Init	0	0	0	0	0	0	0	0	0	0	0	0
Sec/Actuation	0.0	2.0	0.0	0.0	0.0	2.0	0.0	0.0	0.0	0.0	0.0	0.0
Max Initial	4	8	0	4	4	8	0	4	30	30	30	30
Time B4 Reduction	5	5	5	5	5	5	5	5	0	0	0	0
Cars Waiting	0	0	0	0	0	0	0	0	0	0	0	0
Time To Reduce	5	5	5	5	5	5	5	5	0	0	0	0
Minimum Gap	1.5	1.5	1.5	1.5	1.5	1.5	1.5	1.5	0.0	0.0	0.0	0.0

Ped Carryover

Ped Start Phase

Carry Over Phase

1	0
2	0
3	0
4	0
5	0
6	0
7	0
8	0
9	0
10	0
11	0
12	0

Overlap Data

Overlap A	Phase:	1	2	3	4	5	6	7	8	9	10	11	12
Standard.	
Protected	
Permitted	
Enable Lag.	
Enable Lead	
Spare	
Advance Green Timer					0.0								
				Green		Yellow		Red					
Lag/Lead Timers				0.0		0.0		0.0					

Overlap B	Phase:	1	2	3	4	5	6	7	8	9	10	11	12
Standard.	
Protected	
Permitted	
Enable Lag.	
Enable Lead	
Spare	
Advance Green Timer					0.0								
				Green		Yellow		Red					
Lag/Lead Timers				0.0		0.0		0.0					

Overlap C	Phase:	1	2	3	4	5	6	7	8	9	10	11	12
Standard.	
Protected	
Permitted	
Enable Lag.	
Enable Lead	
Spare	
Advance Green Timer					0.0								
				Green		Yellow		Red					
Lag/Lead Timers				0.0		0.0		0.0					

Overlap D	Phase:	1	2	3	4	5	6	7	8	9	10	11	12
Standard.	
Protected	
Permitted	
Enable Lag.	
Enable Lead	
Spare	
Advance Green Timer					0.0								
				Green		Yellow		Red					
Lag/Lead Timers				0.0		0.0		0.0					

Power Start, Remote Flash

```
-----
```

	Phase															
	1	2	3	4	5	6	7	8	9	10	11	12				
Power Start	X	.	.	.	X				
External Start	X	.	.	.	X				
Into Remote Flash.	X	.	.	.	X				
Exit Remote Flash.	X	.	.	.	X	Overlap			
Remote Flash Yellow.	A	B	C	D
Flash Together	X	.	X	.	X

Initialization Interval:

Power Start Yellow
 External Start Yellow

Power Start All Red Time. 4
 Power Start Flash Time. 6

Remote Flash Options:

Out of Flash Yellow YES
 Out of Flash All Red. NO
 Minimum Recall. NO
 Alternate Flash NO
 Flash Thru Load Switches. NO
 Cycle Through Phases. NO

Option Data

	Phase											
	1	2	3	4	5	6	7	8	9	10	11	12
Guaranteed Passage . . .	X	X	.	X	X	X	.	X
Call To NonActuated 1
Call To NonActuated 2
Dual Entry.	X	.	.	.	X
Conditional Service . . .	X
Conditional Reservice
Actuated Rest in Walk
Flashing Walk

Enable Programmable Options

Dual Entry.	ON	Backup Protection Group 1	OFF
Conditional Service	OFF	Backup Protection Group 2	OFF
Ped Clearance Protection. . . .	OFF	Backup Protection Group 3	OFF
Special Preempt Overlap Flash .	OFF	Simultaneous Gap Group 1.	OFF
Cond Service Det Cross Switch .	OFF	Simultaneous Gap Group 2.	OFF
Lock Detectors in Red Only. . .	OFF	Simultaneous Gap Group 3.	OFF

Five Section Left Turn Control

	Phases: 5-2	7-4	1-6	3-8	11-10	9-12
Left Turn Head.

Detector Type/Timers

Det.	Locking	Log	Timers		Don't Reset	Type
	Memory	Enable	Extend	Delay	Extend	
1	NO	NO	0.0	0	.	0 - Normal
2	NO	NO	0.5	0	.	1 - Extend/Delay
3	NO	NO	0.0	0	.	0 - Normal
4	NO	NO	0.0	0	.	0 - Normal
5	NO	NO	0.0	0	.	0 - Normal
6	NO	NO	0.5	0	.	1 - Extend/Delay
7	NO	NO	0.0	0	.	0 - Normal
8	NO	NO	0.0	0	.	0 - Normal
9	NO	NO	0.0	0	.	0 - Normal
10	NO	NO	0.0	0	.	0 - Normal
11	NO	NO	0.0	0	.	0 - Normal
12	NO	NO	0.0	0	.	0 - Normal
13	NO	NO	0.0	0	.	0 - Normal
14	NO	NO	0.0	0	.	0 - Normal
15	NO	NO	0.0	0	.	0 - Normal
16	NO	NO	0.0	0	.	0 - Normal
17	NO	NO	0.0	0	.	0 - Normal
18	NO	NO	0.0	0	.	0 - Normal
19	NO	NO	0.0	0	.	0 - Normal
20	NO	NO	0.0	0	.	0 - Normal
21	NO	NO	0.0	0	.	0 - Normal
22	NO	NO	0.0	0	.	0 - Normal
23	NO	NO	0.0	0	.	0 - Normal
24	NO	NO	0.0	0	.	0 - Normal
25	NO	NO	0.0	0	.	0 - Normal
26	NO	NO	0.0	0	.	0 - Normal
27	NO	NO	0.0	0	.	0 - Normal
28	NO	NO	0.0	0	.	0 - Normal
29	NO	NO	0.0	0	.	0 - Normal
30	NO	NO	0.0	0	.	0 - Normal
31	NO	NO	0.0	0	.	0 - Normal
32	NO	NO	0.0	0	.	0 - Normal

Detector Names

Det 1: Detector 1	Det 17: Detector 17
Det 2: Detector 2	Det 18: Detector 18
Det 3: Detector 3	Det 19: Detector 19
Det 4: Detector 4	Det 20: Detector 20
Det 5: Detector 5	Det 21: Detector 21
Det 6: Detector 6	Det 22: Detector 22
Det 7: Detector 7	Det 23: Detector 23
Det 8: Detector 8	Det 24: Detector 24
Det 9: Detector 9	Det 25: Detector 25
Det 10: Detector 10	Det 26: Detector 26
Det 11: Detector 11	Det 27: Detector 27
Det 12: Detector 12	Det 28: Detector 28
Det 13: Detector 13	Det 29: Detector 29
Det 14: Detector 14	Det 30: Detector 30
Det 15: Detector 15	Det 31: Detector 31
Det 16: Detector 16	Det 32: Detector 32

Detector Type/Timers

33	NO	NO	0.0	0	.	0 - Normal
34	NO	NO	0.0	0	.	0 - Normal
35	NO	NO	0.0	0	.	0 - Normal
36	NO	NO	0.0	0	.	0 - Normal
37	NO	NO	0.0	0	.	0 - Normal
38	NO	NO	0.0	0	.	0 - Normal
39	NO	NO	0.0	0	.	0 - Normal
40	NO	NO	0.0	0	.	0 - Normal
41	NO	NO	0.0	0	.	0 - Normal
42	NO	NO	0.0	0	.	0 - Normal
43	NO	NO	0.0	0	.	0 - Normal
44	NO	NO	0.0	0	.	0 - Normal
45	NO	NO	0.0	0	.	0 - Normal
46	NO	NO	0.0	0	.	0 - Normal
47	NO	NO	0.0	0	.	0 - Normal
48	NO	NO	0.0	0	.	0 - Normal
49	NO	NO	0.0	0	.	0 - Normal
50	NO	NO	0.0	0	.	0 - Normal
51	NO	NO	0.0	0	.	0 - Normal
52	NO	NO	0.0	0	.	0 - Normal
53	NO	NO	0.0	0	.	0 - Normal
54	NO	NO	0.0	0	.	0 - Normal
55	NO	NO	0.0	0	.	0 - Normal
56	NO	NO	0.0	0	.	0 - Normal
57	NO	NO	0.0	0	.	0 - Normal
58	NO	NO	0.0	0	.	0 - Normal
59	NO	NO	0.0	0	.	0 - Normal
60	NO	NO	0.0	0	.	0 - Normal
61	NO	NO	0.0	0	.	0 - Normal
62	NO	NO	0.0	0	.	0 - Normal
63	NO	NO	0.0	0	.	0 - Normal
64	NO	NO	0.0	0	.	0 - Normal

Detector Names

Det 33: Detector 33	Det 49: Detector 49
Det 34: Detector 34	Det 50: Detector 50
Det 35: Detector 35	Det 51: Detector 51
Det 36: Detector 36	Det 52: Detector 52
Det 37: Detector 37	Det 53: Detector 53
Det 38: Detector 38	Det 54: Detector 54
Det 39: Detector 39	Det 55: Detector 55
Det 40: Detector 40	Det 56: Detector 56
Det 41: Detector 41	Det 57: Detector 57
Det 42: Detector 42	Det 58: Detector 58
Det 43: Detector 43	Det 59: Detector 59
Det 44: Detector 44	Det 60: Detector 60
Det 45: Detector 45	Det 61: Detector 61
Det 46: Detector 46	Det 62: Detector 62
Det 47: Detector 47	Det 63: Detector 63
Det 48: Detector 48	Det 64: Detector 64

Ped/SD Local Assign,Log Interval

	Phase Ped Detector											
	1	2	3	4	5	6	7	8	9	10	11	12
Is Ped Detector No. . . .	1	2	3	4	5	6	7	8	9	10	11	12

	*Local System Detector No.															
	1	2	3	4	5	6	7	8	9	10	11	12	13	14	15	16
Is Local Detector No. . . .	0	0	0	0	0	0	0	0	0	0	0	0	0	0	0	0

Detector Log Interval . . . 0

*NOTE: System master designations cross referenced to local system detector numbers are:

- SDA1 = 1 & 9
- SDA2 = 2 & 10
- SDB1 = 3 & 11
- SDB2 = 4 & 12
- SDC1 = 5 & 13
- SDC2 = 6 & 14
- SDD1 = 7 & 15
- SDD2 = 8 & 16

Diagnostic Plans/Fail Action

		Detector															
Plan		1	2	3	4	5	6	7	8	9	10	11	12	13	14	15	16
1	Diagnostic	0	0	0	0	0	0	0	0	0	0	0	0	0	0	0	0
	Scaling	1	1	1	1	1	1	1	1	1	1	1	1	1	1	1	1
2	Diagnostic	0	0	0	0	0	0	0	0	0	0	0	0	0	0	0	0
	Scaling	1	1	1	1	1	1	1	1	1	1	1	1	1	1	1	1
3	Diagnostic	0	0	0	0	0	0	0	0	0	0	0	0	0	0	0	0
	Scaling	1	1	1	1	1	1	1	1	1	1	1	1	1	1	1	1
4	Diagnostic	0	0	0	0	0	0	0	0	0	0	0	0	0	0	0	0
	Scaling	1	1	1	1	1	1	1	1	1	1	1	1	1	1	1	1
5	Diagnostic	0	0	0	0	0	0	0	0	0	0	0	0	0	0	0	0
	Scaling	1	1	1	1	1	1	1	1	1	1	1	1	1	1	1	1
6	Diagnostic	0	0	0	0	0	0	0	0	0	0	0	0	0	0	0	0
	Scaling	1	1	1	1	1	1	1	1	1	1	1	1	1	1	1	1
7	Diagnostic	0	0	0	0	0	0	0	0	0	0	0	0	0	0	0	0
	Scaling	1	1	1	1	1	1	1	1	1	1	1	1	1	1	1	1
8	Diagnostic	0	0	0	0	0	0	0	0	0	0	0	0	0	0	0	0
	Scaling	1	1	1	1	1	1	1	1	1	1	1	1	1	1	1	1
	*Fail Action	0	0	0	0	0	0	0	0	0	0	0	0	0	0	0	0

		Detector															
Plan		17	18	19	20	21	22	23	24	25	26	27	28	29	30	31	32
1	Diagnostic	0	0	0	0	0	0	0	0	0	0	0	0	0	0	0	0
	Scaling	1	1	1	1	1	1	1	1	1	1	1	1	1	1	1	1
2	Diagnostic	0	0	0	0	0	0	0	0	0	0	0	0	0	0	0	0
	Scaling	1	1	1	1	1	1	1	1	1	1	1	1	1	1	1	1
3	Diagnostic	0	0	0	0	0	0	0	0	0	0	0	0	0	0	0	0
	Scaling	1	1	1	1	1	1	1	1	1	1	1	1	1	1	1	1
4	Diagnostic	0	0	0	0	0	0	0	0	0	0	0	0	0	0	0	0
	Scaling	1	1	1	1	1	1	1	1	1	1	1	1	1	1	1	1
5	Diagnostic	0	0	0	0	0	0	0	0	0	0	0	0	0	0	0	0
	Scaling	1	1	1	1	1	1	1	1	1	1	1	1	1	1	1	1
6	Diagnostic	0	0	0	0	0	0	0	0	0	0	0	0	0	0	0	0
	Scaling	1	1	1	1	1	1	1	1	1	1	1	1	1	1	1	1
7	Diagnostic	0	0	0	0	0	0	0	0	0	0	0	0	0	0	0	0
	Scaling	1	1	1	1	1	1	1	1	1	1	1	1	1	1	1	1
8	Diagnostic	0	0	0	0	0	0	0	0	0	0	0	0	0	0	0	0
	Scaling	1	1	1	1	1	1	1	1	1	1	1	1	1	1	1	1
	*Fail Action	0	0	0	0	0	0	0	0	0	0	0	0	0	0	0	0

*NOTE: 0 = No Action, 1 = Min Recall, 2 = Max Recall in Effect
 3 = Detector Fail Max Time from By-Phase Timing Data

Diagnostic Plans/Fail Action

Plan		Detector															
		33	34	35	36	37	38	39	40	41	42	43	44	45	46	47	48
1	Diagnostic	0	0	0	0	0	0	0	0	0	0	0	0	0	0	0	0
	Scaling	1	1	1	1	1	1	1	1	1	1	1	1	1	1	1	1
2	Diagnostic	0	0	0	0	0	0	0	0	0	0	0	0	0	0	0	0
	Scaling	1	1	1	1	1	1	1	1	1	1	1	1	1	1	1	1
3	Diagnostic	0	0	0	0	0	0	0	0	0	0	0	0	0	0	0	0
	Scaling	1	1	1	1	1	1	1	1	1	1	1	1	1	1	1	1
4	Diagnostic	0	0	0	0	0	0	0	0	0	0	0	0	0	0	0	0
	Scaling	1	1	1	1	1	1	1	1	1	1	1	1	1	1	1	1
5	Diagnostic	0	0	0	0	0	0	0	0	0	0	0	0	0	0	0	0
	Scaling	1	1	1	1	1	1	1	1	1	1	1	1	1	1	1	1
6	Diagnostic	0	0	0	0	0	0	0	0	0	0	0	0	0	0	0	0
	Scaling	1	1	1	1	1	1	1	1	1	1	1	1	1	1	1	1
7	Diagnostic	0	0	0	0	0	0	0	0	0	0	0	0	0	0	0	0
	Scaling	1	1	1	1	1	1	1	1	1	1	1	1	1	1	1	1
8	Diagnostic	0	0	0	0	0	0	0	0	0	0	0	0	0	0	0	0
	Scaling	1	1	1	1	1	1	1	1	1	1	1	1	1	1	1	1
	*Fail Action	0	0	0	0	0	0	0	0	0	0	0	0	0	0	0	0

Plan		Detector															
		49	50	51	52	53	54	55	56	57	58	59	60	61	62	63	64
1	Diagnostic	0	0	0	0	0	0	0	0	0	0	0	0	0	0	0	0
	Scaling	1	1	1	1	1	1	1	1	1	1	1	1	1	1	1	1
2	Diagnostic	0	0	0	0	0	0	0	0	0	0	0	0	0	0	0	0
	Scaling	1	1	1	1	1	1	1	1	1	1	1	1	1	1	1	1
3	Diagnostic	0	0	0	0	0	0	0	0	0	0	0	0	0	0	0	0
	Scaling	1	1	1	1	1	1	1	1	1	1	1	1	1	1	1	1
4	Diagnostic	0	0	0	0	0	0	0	0	0	0	0	0	0	0	0	0
	Scaling	1	1	1	1	1	1	1	1	1	1	1	1	1	1	1	1
5	Diagnostic	0	0	0	0	0	0	0	0	0	0	0	0	0	0	0	0
	Scaling	1	1	1	1	1	1	1	1	1	1	1	1	1	1	1	1
6	Diagnostic	0	0	0	0	0	0	0	0	0	0	0	0	0	0	0	0
	Scaling	1	1	1	1	1	1	1	1	1	1	1	1	1	1	1	1
7	Diagnostic	0	0	0	0	0	0	0	0	0	0	0	0	0	0	0	0
	Scaling	1	1	1	1	1	1	1	1	1	1	1	1	1	1	1	1
8	Diagnostic	0	0	0	0	0	0	0	0	0	0	0	0	0	0	0	0
	Scaling	1	1	1	1	1	1	1	1	1	1	1	1	1	1	1	1
	*Fail Action	0	0	0	0	0	0	0	0	0	0	0	0	0	0	0	0

*NOTE: 0 = No Action, 1 = Min Recall, 2 = Max Recall in Effect
 3 = Detector Fail Max Time from By-Phase Timing Data

Detector Diagnostic Intervals

Diagnostic Number	*No-Activity Diagnostic Interval	*Max Presence Diagnostic Interval	Erratic Counts
1	0	0	0
2	0	0	0
3	0	0	0
4	0	0	0
5	0	0	0
6	0	0	0
7	0	0	0
8	0	0	0
9	0	0	0
10	0	0	0
11	0	0	0
12	0	0	0
13	0	0	0
14	0	0	0
15	0	0	0
16	0	0	0
17	0	0	0
18	0	0	0
19	0	0	0
20	0	0	0
21	0	0	0
22	0	0	0
23	0	0	0
24	0	0	0
25	0	0	0
26	0	0	0
27	0	0	0
28	0	0	0
29	0	0	0
30	0	0	0
31	0	0	0
32	0	0	0

*NOTE: Scaling is specified in each detector diagnostic plan.

Speed Detectors

	Local Speed Detector							
One Detector Speed:	1	2	3	4	5	6	7	8
Local Detector Number.	0	0	0	0	0	0	0	0
Vehicle Length	0	0	0	0	0	0	0	0
Loop Length.	0	0	0	0	0	0	0	0
Two Detector Speed:								
Local Detector Number.	0	0	0	0	0	0	0	0
Speed Trap Length.	0	0	0	0	0	0	0	0

	Local Speed Detector							
One Detector Speed:	9	10	11	12	13	14	15	16
Local Detector Number.	0	0	0	0	0	0	0	0
Vehicle Length	0	0	0	0	0	0	0	0
Loop Length.	0	0	0	0	0	0	0	0
Two Detector Speed:								
Local Detector Number.	0	0	0	0	0	0	0	0
Speed Trap Length.	0	0	0	0	0	0	0	0

Units. Inches

NOTE: Speed Detector 1 = STA, Speed Detector 2 = STB

Coordinator Manual Command and Options

```

-----
Manual Enable . . . . . Pattern . . . . . 0

Split Units . . . . . Seconds          OffsetUnits . . . . . Seconds
Interconnect Format . STD              Interconnect Source . TLM
Transition. . . . . SMOOTH             Dwell Period. . . . . 0
Resync Count. . . . . 0

```

```

Actuated Coord Phase . . . . X Actuated Walk Rest . . . . .
Inhibit Max Timing . . . . . X Max 2 Select . . . . .
Floating Force Off . . . . . Multisync. . . . .

```

			Phase											
Split Demand:	Call Time	Cyc Count	1	2	3	4	5	6	7	8	9	10	11	12
Demand 1 . .	0	0
Demand 2 . .	0	0

			Phase											
Auto Permissive Min Green .	1	2	3	4	5	6	7	8	9	10	11	12		
	0	0	0	0	0	0	0	0	0	0	0	0		

			Phase					
Free Alternate Sequence . .	A	B	C	D	E	F		
		

Coordination Patterns

Preemptors

Preemptor 1

Active	Det Lock.	Ped Dark
Priority Preemption.	Yel-Red To Grn.	Ped Active
Outputs Only During Hold	Flash All Outputs	Zero Ped Clr Time.
Terminate Overlap ASAP	Terminate Phases.	Ped Clr Thru Yel
Don't Override Flash	Duration Time.	0
Flash During Hold.	Delay Time	0
No CVM in Flash.	Inhibit Time	0
Fast Flash Grn on Hold Phase.	Min Ped Clear.	0
Enable Max Time.	Max Time	0
	Exit Max	0
	Min Hold Time.	0
	Hold Delay Time.	0

	Green	Yellow	Red
Minimum	0	0.0	0.0
Track Clear	0	0.0	0.0
Hold.		0.0	0.0

	Phase/Overlap	1	2	3	4	5	6	7	8	9	10	11	12/	A	B	C	D
Terminate Overlap
Track Clearance Phase
Hold Phases
Exit Phases
Exit Calls on Phase

Out of Flash Color for Exit Phases Green

Preemptor 2

Active	Det Lock.	Ped Dark
Priority Preemption.	Yel-Red To Grn.	Ped Active
Outputs Only During Hold	Flash All Outputs	Zero Ped Clr Time.
Terminate Overlap ASAP	Terminate Phases.	Ped Clr Thru Yel
Don't Override Flash	Duration Time.	0
Flash During Hold.	Delay Time	0
No CVM in Flash.	Inhibit Time	0
Fast Flash Grn on Hold Phase.	Min Ped Clear.	0
Enable Max Time.	Max Time	0
	Exit Max	0
	Min Hold Time.	0
	Hold Delay Time.	0

	Green	Yellow	Red
Minimum	0	0.0	0.0
Track Clear	0	0.0	0.0
Hold.		0.0	0.0

	Phase/Overlap	1	2	3	4	5	6	7	8	9	10	11	12/	A	B	C	D
Terminate Overlap
Track Clearance Phase
Hold Phases
Exit Phases
Exit Calls on Phase

Out of Flash Color for Exit Phases Green

Linked Preemptor 0

Preemptors

Preemptor 5

```

Active . . . . . X Det Lock. . . . . Ped Dark . . . . .
Priority Preemption. . . . . Yel-Red To Grn. . . . . Ped Active . . . . .
Outputs Only During Hold . . . . . Flash All Outputs . . . . . Zero Ped Clr Time. . . . .
Terminate Overlap ASAP . . . . . Terminate Phases. . . . . Ped Clr Thru Yel . . . . .
Don't Override Flash . . . . . Duration Time. . . . . 0
Flash During Hold. . . . . Delay Time . . . . . 0
No CVM in Flash. . . . . Inhibit Time . . . . . 0
Fast Flash Grn on Hold Phase. . . . . Min Ped Clear. . . . . 0
Enable Max Time. . . . . Max Time . . . . . 0
                               Exit Max . . . . . 0
                               Min Hold Time. . . . . 10
                               Hold Delay Time. . . . . 0

```

```

                               Green           Yellow           Red
Minimum . . . . . 0           0.0           0.0
Track Clear . . . . . 0           0.0           0.0
Hold. . . . .           0.0           0.0

```

```

Phase/Overlap 1 2 3 4 5 6 7 8 9 10 11 12/ A B C D
Terminate Overlap . . . . . . . . . . . . . . . . . . . . . . . . . . . .
Track Clearance Phase . . . . . . . . . . . . . . . . . . . . . . . . . . . .
Hold Phases . . . . . X . . . . . X . . . . . . . . . . . . . . . . . . . . . .
Exit Phases . . . . . . X . . . . . X . . . . . . . . . . . . . . . . . . . . . .
Exit Calls on Phase . . . . . . . . . . . . . . . . . . . . . . . . . . . .

```

```

Out of Flash Color for Exit Phases . . . . . Green
Linked Preemptor . . . . . 0

```

Preemptor 6

```

Active . . . . . X Det Lock. . . . . Ped Dark . . . . .
Priority Preemption. . . . . Yel-Red To Grn. . . . . Ped Active . . . . .
Outputs Only During Hold . . . . . Flash All Outputs . . . . . Zero Ped Clr Time. . . . .
Terminate Overlap ASAP . . . . . Terminate Phases. . . . . Ped Clr Thru Yel . . . . .
Don't Override Flash . . . . . Duration Time. . . . . 0
Flash During Hold. . . . . Delay Time . . . . . 0
No CVM in Flash. . . . . Inhibit Time . . . . . 0
Fast Flash Grn on Hold Phase. . . . . Min Ped Clear. . . . . 0
Enable Max Time. . . . . Max Time . . . . . 0
                               Exit Max . . . . . 0
                               Min Hold Time. . . . . 0
                               Hold Delay Time. . . . . 0

```

```

                               Green           Yellow           Red
Minimum . . . . . 0           0.0           0.0
Track Clear . . . . . 0           0.0           0.0
Hold. . . . .           0.0           0.0

```

```

Phase/Overlap 1 2 3 4 5 6 7 8 9 10 11 12/ A B C D
Terminate Overlap . . . . . . . . . . . . . . . . . . . . . . . . . . . .
Track Clearance Phase . . . . . . . . . . . . . . . . . . . . . . . . . . . .
Hold Phases . . . . . . . . . . . . . . . . X . . . . . . . . . . . . . . . . . . . . . .
Exit Phases . . . . . . . . . . . X . . . . . . . . . . . . . . . . . . . . . .
Exit Calls on Phase . . . . . . . . . . . . . . . . . . . . . . . . . . . .

```

```

Out of Flash Color for Exit Phases . . . . . Green
Linked Preemptor . . . . . 0

```

NIC/TOD Clock/Calendar

Manual NIC Program Step 0

Manual TOD Program Step 0

NIC Resync Time 0300

Sync Reference is Last Event

Week 1 Begins on 1st Sunday NO If NO, then week containing Jan. 1

Disable Daylight Savings Time NO

Daylight Savings

Begins Last Sunday in March NO If NO, then Second Sunday as per 2007 DST Law

TOD Weekly/Yearly

	Weekly Program Numbers										Program No.	
	1	2	3	4	5	6	7	8	9	10		
Sunday . . .	2	1	1	1	1	1	1	1	1	1	1	Program No.
Monday . . .	1	1	1	1	1	1	1	1	1	1	1	Program No.
Tuesday . . .	1	1	1	1	1	1	1	1	1	1	1	Program No.
Wednesday . .	1	1	1	1	1	1	1	1	1	1	1	Program No.
Thursday . . .	1	1	1	1	1	1	1	1	1	1	1	Program No.
Friday . . .	1	1	1	1	1	1	1	1	1	1	1	Program No.
Saturday . . .	2	1	1	1	1	1	1	1	1	1	1	Program No.

Prog	Week of Year																	
	1	2	3	4	5	6	7	8	9	10	11	12	13	14	15	16	17	18
Prog	1	1	1	1	1	1	1	1	1	1	1	1	1	1	1	1	1	1
Prog	19	20	21	22	23	24	25	26	27	28	29	30	31	32	33	34	35	36
Prog	37	38	39	40	41	42	43	44	45	46	47	48	49	50	51	52	53	

Holiday Programs

Holiday	Type	Month	Day of Week/ Day of Month	Week of Year/ Year	Program
1	Fixed	0	0	0	0
2	Fixed	0	0	0	0
3	Fixed	0	0	0	0
4	Fixed	0	0	0	0
5	Fixed	0	0	0	0
6	Fixed	0	0	0	0
7	Fixed	0	0	0	0
8	Fixed	0	0	0	0
9	Fixed	0	0	0	0
10	Fixed	0	0	0	0
11	Fixed	0	0	0	0
12	Fixed	0	0	0	0
13	Fixed	0	0	0	0
14	Fixed	0	0	0	0
15	Fixed	0	0	0	0
16	Fixed	0	0	0	0
17	Fixed	0	0	0	0
18	Fixed	0	0	0	0
19	Fixed	0	0	0	0
20	Fixed	0	0	0	0
21	Fixed	0	0	0	0
22	Fixed	0	0	0	0
23	Fixed	0	0	0	0
24	Fixed	0	0	0	0
25	Fixed	0	0	0	0
26	Fixed	0	0	0	0
27	Fixed	0	0	0	0
28	Fixed	0	0	0	0
29	Fixed	0	0	0	0
30	Fixed	0	0	0	0
31	Fixed	0	0	0	0
32	Fixed	0	0	0	0
33	Fixed	0	0	0	0
34	Fixed	0	0	0	0
35	Fixed	0	0	0	0
36	Fixed	0	0	0	0

NIC Program Steps

Step	Program	Step Begins	Pattern	Override
------	---------	-------------	---------	----------

TOD Program Steps

Step 1 Program 1 Step Begins 0600

Flash. Dimming Enable.
 Red Rest Alt Veh Extension
 Spare 5. Det Log Enable.
 Spare 3. Spare 4
 Type 0 Dly Enable. Spare 2
 Det Diag Plan. 0

	Phase Number											
	1	2	3	4	5	6	7	8	9	10	11	12
Max 2 Enable	X	.	.	.	X
Max 3 Enable
Veh Recall
Veh Max Recall
Ped Recall
Cond Service Inhibit.
Phase Omit
Special Function

	A	B	C	D	E	F
Alt Sequence

Step 2 Program 1 Step Begins 0930

Flash. Dimming Enable.
 Red Rest Alt Veh Extension
 Spare 5. Det Log Enable.
 Spare 3. Spare 4
 Type 0 Dly Enable. Spare 2
 Det Diag Plan. 0

	Phase Number											
	1	2	3	4	5	6	7	8	9	10	11	12
Max 2 Enable
Max 3 Enable
Veh Recall
Veh Max Recall
Ped Recall
Cond Service Inhibit.
Phase Omit
Special Function

	A	B	C	D	E	F
Alt Sequence

Configuration

	Controller Sequence Priority											
	1	2	3	4	5	6	7	8	9	10	11	12
Ring 1 Phases . .	1	2	3	4	9	10	0	0	0	0	0	0
Ring 2 Phases . .	5	6	7	8	11	12	0	0	0	0	0	0

	Phase											
	1	2	3	4	5	6	7	8	9	10	11	12
In Use.	X	.	X	.	X	.	X
Exclusive Ped
Direction												

	Overlap			
	A	B	C	D
Direction				

Load Switch Channel/Driver Group Assign (Info Only):

Load Switch Channel (MMU)	Driver Phase/Ovlap	Signal Group Ped
1	1	.
2	2	.
3	3	.
4	4	.
5	5	.
6	6	.
7	7	.
8	8	.
9	2	X
10	4	X
11	6	X
12	8	X
13	A	.
14	B	.
15	C	.
16	D	.

Configuration Continued

Event Enabling		Alarm Enabling	
Critical RFE'S (MMU/TF)	X	ALARM 1	X
Non-Critical RFE'S (DET/TEST)	X	ALARM 2	X
Detector Errors	X	ALARM 3	X
Coordination Errors	X	ALARM 4	X
MMU Flash Faults	X	ALARM 5	X
Local Flash Faults	X	ALARM 6	X
Preempt	X	ALARM 7	X
Power On/Off	X	ALARM 8	X
Low Battery	X	ALARM 9	X
		ALARM 10	X
		ALARM 11	X
		ALARM 12	X
		ALARM 13	X
		ALARM 14	X
		ALARM 15	X
		ALARM 16	X

Supervisor Access Code . . . ****
 Data Change Access Code . . . ****

MMU Compatibility Program (Info Only)

Channel	Is Allowed to Time With Channel														
	16	15	14	13	12	11	10	9	8	7	6	5	4	3	2
1
2
3
4
5
6
7
8
9
10
11
12
13
14
15

Version Info:		
Software Assy.	Part No.	Version
Boot	27831	2.83
Program	45561	6.8
Application		. 3
Help	27891	5.43
Configuration	27918	C000

Ped Carryover

Ped Start Phase	Carry Over Phase
-----------------	------------------

1	0
2	0
3	0
4	0
5	0
6	0
7	0
8	0
9	0
10	0
11	0
12	0

Overlap Data

Overlap A	Phase:	1	2	3	4	5	6	7	8	9	10	11	12
Standard.	
Protected	
Permitted	
Enable Lag.	
Enable Lead	
Spare	
Advance Green Timer					0.0								
				Green		Yellow		Red					
Lag/Lead Timers				0.0		0.0		0.0					

Overlap B	Phase:	1	2	3	4	5	6	7	8	9	10	11	12
Standard.	
Protected	
Permitted	
Enable Lag.	
Enable Lead	
Spare	
Advance Green Timer					0.0								
				Green		Yellow		Red					
Lag/Lead Timers				0.0		0.0		0.0					

Overlap C	Phase:	1	2	3	4	5	6	7	8	9	10	11	12
Standard.	
Protected	
Permitted	
Enable Lag.	
Enable Lead	
Spare	
Advance Green Timer					0.0								
				Green		Yellow		Red					
Lag/Lead Timers				0.0		0.0		0.0					

Overlap D	Phase:	1	2	3	4	5	6	7	8	9	10	11	12
Standard.	
Protected	
Permitted	
Enable Lag.	
Enable Lead	
Spare	
Advance Green Timer					0.0								
				Green		Yellow		Red					
Lag/Lead Timers				0.0		0.0		0.0					

Power Start, Remote Flash

	Phase															
	1	2	3	4	5	6	7	8	9	10	11	12				
Power Start.	X	.	.	.	X				
External Start	X	.	.	.	X				
Into Remote Flash.	X	.	.	.	X				
Exit Remote Flash.	X	.	.	.	X	Overlap			
Remote Flash Yellow.	A	B	C	D
Flash Together	X	.	X	.	X	.	X	.	X	.	X	.	X	.	X

Initialization Interval:

Power Start Yellow
 External Start. Yellow

Power Start All Red Time. 4
 Power Start Flash Time. 6

Remote Flash Options:

Out of Flash Yellow NO
 Out of Flash All Red. NO
 Minimum Recall. NO
 Alternate Flash NO
 Flash Thru Load Switches. NO
 Cycle Through Phases. NO

Option Data

	Phase											
	1	2	3	4	5	6	7	8	9	10	11	12
Guaranteed Passage
Call To NonActuated 1	X	.	.	.	X
Call To NonActuated 2	X	.	.	.	X
Dual Entry.	X	.	X	.	X	.	X
Conditional Service
Conditional Reservice
Actuated Rest in Walk
Flashing Walk

Enable Programmable Options

Dual Entry.	ON	Backup Protection Group 1	OFF
Conditional Service	OFF	Backup Protection Group 2	OFF
Ped Clearance Protection.	OFF	Backup Protection Group 3	OFF
Special Preempt Overlap Flash	OFF	Simultaneous Gap Group 1.	OFF
Cond Service Det Cross Switch	OFF	Simultaneous Gap Group 2.	OFF
Lock Detectors in Red Only.	OFF	Simultaneous Gap Group 3.	OFF

Five Section Left Turn Control

	Phases: 5-2	7-4	1-6	3-8	11-10	9-12
Left Turn Head.

Detector Type/Timers

Det.	Locking	Log	Timers		Don't Reset	Type
	Memory	Enable	Extend	Delay	Extend	
1	NO	NO	0.0	0	.	0 - Normal
2	NO	NO	0.0	0	.	0 - Normal
3	NO	NO	0.0	0	.	0 - Normal
4	NO	NO	0.0	0	.	0 - Normal
5	NO	NO	0.0	0	.	0 - Normal
6	NO	NO	0.0	0	.	0 - Normal
7	NO	NO	0.0	0	.	0 - Normal
8	NO	NO	0.0	0	.	0 - Normal
9	NO	NO	0.0	0	.	0 - Normal
10	NO	NO	0.0	0	.	0 - Normal
11	NO	NO	0.0	0	.	0 - Normal
12	NO	NO	0.0	0	.	0 - Normal
13	NO	NO	0.0	0	.	0 - Normal
14	NO	NO	0.0	0	.	0 - Normal
15	NO	NO	0.0	0	.	0 - Normal
16	NO	NO	0.0	0	.	0 - Normal
17	NO	NO	0.0	0	.	0 - Normal
18	NO	NO	0.0	0	.	0 - Normal
19	NO	NO	0.0	0	.	0 - Normal
20	NO	NO	0.0	0	.	0 - Normal
21	NO	NO	0.0	0	.	0 - Normal
22	NO	NO	0.0	0	.	0 - Normal
23	NO	NO	0.0	0	.	0 - Normal
24	NO	NO	0.0	0	.	0 - Normal
25	NO	NO	0.0	0	.	0 - Normal
26	NO	NO	0.0	0	.	0 - Normal
27	NO	NO	0.0	0	.	0 - Normal
28	NO	NO	0.0	0	.	0 - Normal
29	NO	NO	0.0	0	.	0 - Normal
30	NO	NO	0.0	0	.	0 - Normal
31	NO	NO	0.0	0	.	0 - Normal
32	NO	NO	0.0	0	.	0 - Normal

Detector Names

Det 1: Detector 1	Det 17: Detector 17
Det 2: Detector 2	Det 18: Detector 18
Det 3: Detector 3	Det 19: Detector 19
Det 4: Detector 4	Det 20: Detector 20
Det 5: Detector 5	Det 21: Detector 21
Det 6: Detector 6	Det 22: Detector 22
Det 7: Detector 7	Det 23: Detector 23
Det 8: Detector 8	Det 24: Detector 24
Det 9: Detector 9	Det 25: Detector 25
Det 10: Detector 10	Det 26: Detector 26
Det 11: Detector 11	Det 27: Detector 27
Det 12: Detector 12	Det 28: Detector 28
Det 13: Detector 13	Det 29: Detector 29
Det 14: Detector 14	Det 30: Detector 30
Det 15: Detector 15	Det 31: Detector 31
Det 16: Detector 16	Det 32: Detector 32

Detector Type/Timers

33	NO	NO	0.0	0	.	0 - Normal
34	NO	NO	0.0	0	.	0 - Normal
35	NO	NO	0.0	0	.	0 - Normal
36	NO	NO	0.0	0	.	0 - Normal
37	NO	NO	0.0	0	.	0 - Normal
38	NO	NO	0.0	0	.	0 - Normal
39	NO	NO	0.0	0	.	0 - Normal
40	NO	NO	0.0	0	.	0 - Normal
41	NO	NO	0.0	0	.	0 - Normal
42	NO	NO	0.0	0	.	0 - Normal
43	NO	NO	0.0	0	.	0 - Normal
44	NO	NO	0.0	0	.	0 - Normal
45	NO	NO	0.0	0	.	0 - Normal
46	NO	NO	0.0	0	.	0 - Normal
47	NO	NO	0.0	0	.	0 - Normal
48	NO	NO	0.0	0	.	0 - Normal
49	NO	NO	0.0	0	.	0 - Normal
50	NO	NO	0.0	0	.	0 - Normal
51	NO	NO	0.0	0	.	0 - Normal
52	NO	NO	0.0	0	.	0 - Normal
53	NO	NO	0.0	0	.	0 - Normal
54	NO	NO	0.0	0	.	0 - Normal
55	NO	NO	0.0	0	.	0 - Normal
56	NO	NO	0.0	0	.	0 - Normal
57	NO	NO	0.0	0	.	0 - Normal
58	NO	NO	0.0	0	.	0 - Normal
59	NO	NO	0.0	0	.	0 - Normal
60	NO	NO	0.0	0	.	0 - Normal
61	NO	NO	0.0	0	.	0 - Normal
62	NO	NO	0.0	0	.	0 - Normal
63	NO	NO	0.0	0	.	0 - Normal
64	NO	NO	0.0	0	.	0 - Normal

Detector Names

Det 33: Detector 33	Det 49: Detector 49
Det 34: Detector 34	Det 50: Detector 50
Det 35: Detector 35	Det 51: Detector 51
Det 36: Detector 36	Det 52: Detector 52
Det 37: Detector 37	Det 53: Detector 53
Det 38: Detector 38	Det 54: Detector 54
Det 39: Detector 39	Det 55: Detector 55
Det 40: Detector 40	Det 56: Detector 56
Det 41: Detector 41	Det 57: Detector 57
Det 42: Detector 42	Det 58: Detector 58
Det 43: Detector 43	Det 59: Detector 59
Det 44: Detector 44	Det 60: Detector 60
Det 45: Detector 45	Det 61: Detector 61
Det 46: Detector 46	Det 62: Detector 62
Det 47: Detector 47	Det 63: Detector 63
Det 48: Detector 48	Det 64: Detector 64

Ped/SD Local Assign,Log Interval

	Phase Ped Detector											
	1	2	3	4	5	6	7	8	9	10	11	12
Is Ped Detector No. . . .	1	2	3	4	5	6	7	8	9	10	11	12

	*Local System Detector No.															
	1	2	3	4	5	6	7	8	9	10	11	12	13	14	15	16
Is Local Detector No. . . .	0	0	0	0	0	0	0	0	0	0	0	0	0	0	0	0

Detector Log Interval . . . 0

*NOTE: System master designations cross referenced to local system detector numbers are:
 SDA1 = 1 & 9
 SDA2 = 2 & 10
 SDB1 = 3 & 11
 SDB2 = 4 & 12
 SDC1 = 5 & 13
 SDC2 = 6 & 14
 SDD1 = 7 & 15
 SDD2 = 8 & 16

Diagnostic Plans/Fail Action

		Detector															
Plan		1	2	3	4	5	6	7	8	9	10	11	12	13	14	15	16
1	Diagnostic	0	0	0	0	0	0	0	0	0	0	0	0	0	0	0	0
	Scaling	1	1	1	1	1	1	1	1	1	1	1	1	1	1	1	1
2	Diagnostic	0	0	0	0	0	0	0	0	0	0	0	0	0	0	0	0
	Scaling	1	1	1	1	1	1	1	1	1	1	1	1	1	1	1	1
3	Diagnostic	0	0	0	0	0	0	0	0	0	0	0	0	0	0	0	0
	Scaling	1	1	1	1	1	1	1	1	1	1	1	1	1	1	1	1
4	Diagnostic	0	0	0	0	0	0	0	0	0	0	0	0	0	0	0	0
	Scaling	1	1	1	1	1	1	1	1	1	1	1	1	1	1	1	1
5	Diagnostic	0	0	0	0	0	0	0	0	0	0	0	0	0	0	0	0
	Scaling	1	1	1	1	1	1	1	1	1	1	1	1	1	1	1	1
6	Diagnostic	0	0	0	0	0	0	0	0	0	0	0	0	0	0	0	0
	Scaling	1	1	1	1	1	1	1	1	1	1	1	1	1	1	1	1
7	Diagnostic	0	0	0	0	0	0	0	0	0	0	0	0	0	0	0	0
	Scaling	1	1	1	1	1	1	1	1	1	1	1	1	1	1	1	1
8	Diagnostic	0	0	0	0	0	0	0	0	0	0	0	0	0	0	0	0
	Scaling	1	1	1	1	1	1	1	1	1	1	1	1	1	1	1	1
	*Fail Action	0	0	0	0	0	0	0	0	0	0	0	0	0	0	0	0

		Detector															
Plan		17	18	19	20	21	22	23	24	25	26	27	28	29	30	31	32
1	Diagnostic	0	0	0	0	0	0	0	0	0	0	0	0	0	0	0	0
	Scaling	1	1	1	1	1	1	1	1	1	1	1	1	1	1	1	1
2	Diagnostic	0	0	0	0	0	0	0	0	0	0	0	0	0	0	0	0
	Scaling	1	1	1	1	1	1	1	1	1	1	1	1	1	1	1	1
3	Diagnostic	0	0	0	0	0	0	0	0	0	0	0	0	0	0	0	0
	Scaling	1	1	1	1	1	1	1	1	1	1	1	1	1	1	1	1
4	Diagnostic	0	0	0	0	0	0	0	0	0	0	0	0	0	0	0	0
	Scaling	1	1	1	1	1	1	1	1	1	1	1	1	1	1	1	1
5	Diagnostic	0	0	0	0	0	0	0	0	0	0	0	0	0	0	0	0
	Scaling	1	1	1	1	1	1	1	1	1	1	1	1	1	1	1	1
6	Diagnostic	0	0	0	0	0	0	0	0	0	0	0	0	0	0	0	0
	Scaling	1	1	1	1	1	1	1	1	1	1	1	1	1	1	1	1
7	Diagnostic	0	0	0	0	0	0	0	0	0	0	0	0	0	0	0	0
	Scaling	1	1	1	1	1	1	1	1	1	1	1	1	1	1	1	1
8	Diagnostic	0	0	0	0	0	0	0	0	0	0	0	0	0	0	0	0
	Scaling	1	1	1	1	1	1	1	1	1	1	1	1	1	1	1	1
	*Fail Action	0	0	0	0	0	0	0	0	0	0	0	0	0	0	0	0

*NOTE: 0 = No Action, 1 = Min Recall, 2 = Max Recall in Effect
 3 = Detector Fail Max Time from By-Phase Timing Data

Diagnostic Plans/Fail Action

Plan		Detector															
		33	34	35	36	37	38	39	40	41	42	43	44	45	46	47	48
1	Diagnostic	0	0	0	0	0	0	0	0	0	0	0	0	0	0	0	0
	Scaling	1	1	1	1	1	1	1	1	1	1	1	1	1	1	1	1
2	Diagnostic	0	0	0	0	0	0	0	0	0	0	0	0	0	0	0	0
	Scaling	1	1	1	1	1	1	1	1	1	1	1	1	1	1	1	1
3	Diagnostic	0	0	0	0	0	0	0	0	0	0	0	0	0	0	0	0
	Scaling	1	1	1	1	1	1	1	1	1	1	1	1	1	1	1	1
4	Diagnostic	0	0	0	0	0	0	0	0	0	0	0	0	0	0	0	0
	Scaling	1	1	1	1	1	1	1	1	1	1	1	1	1	1	1	1
5	Diagnostic	0	0	0	0	0	0	0	0	0	0	0	0	0	0	0	0
	Scaling	1	1	1	1	1	1	1	1	1	1	1	1	1	1	1	1
6	Diagnostic	0	0	0	0	0	0	0	0	0	0	0	0	0	0	0	0
	Scaling	1	1	1	1	1	1	1	1	1	1	1	1	1	1	1	1
7	Diagnostic	0	0	0	0	0	0	0	0	0	0	0	0	0	0	0	0
	Scaling	1	1	1	1	1	1	1	1	1	1	1	1	1	1	1	1
8	Diagnostic	0	0	0	0	0	0	0	0	0	0	0	0	0	0	0	0
	Scaling	1	1	1	1	1	1	1	1	1	1	1	1	1	1	1	1
	*Fail Action	0	0	0	0	0	0	0	0	0	0	0	0	0	0	0	0

Plan		Detector															
		49	50	51	52	53	54	55	56	57	58	59	60	61	62	63	64
1	Diagnostic	0	0	0	0	0	0	0	0	0	0	0	0	0	0	0	0
	Scaling	1	1	1	1	1	1	1	1	1	1	1	1	1	1	1	1
2	Diagnostic	0	0	0	0	0	0	0	0	0	0	0	0	0	0	0	0
	Scaling	1	1	1	1	1	1	1	1	1	1	1	1	1	1	1	1
3	Diagnostic	0	0	0	0	0	0	0	0	0	0	0	0	0	0	0	0
	Scaling	1	1	1	1	1	1	1	1	1	1	1	1	1	1	1	1
4	Diagnostic	0	0	0	0	0	0	0	0	0	0	0	0	0	0	0	0
	Scaling	1	1	1	1	1	1	1	1	1	1	1	1	1	1	1	1
5	Diagnostic	0	0	0	0	0	0	0	0	0	0	0	0	0	0	0	0
	Scaling	1	1	1	1	1	1	1	1	1	1	1	1	1	1	1	1
6	Diagnostic	0	0	0	0	0	0	0	0	0	0	0	0	0	0	0	0
	Scaling	1	1	1	1	1	1	1	1	1	1	1	1	1	1	1	1
7	Diagnostic	0	0	0	0	0	0	0	0	0	0	0	0	0	0	0	0
	Scaling	1	1	1	1	1	1	1	1	1	1	1	1	1	1	1	1
8	Diagnostic	0	0	0	0	0	0	0	0	0	0	0	0	0	0	0	0
	Scaling	1	1	1	1	1	1	1	1	1	1	1	1	1	1	1	1
	*Fail Action	0	0	0	0	0	0	0	0	0	0	0	0	0	0	0	0

*NOTE: 0 = No Action, 1 = Min Recall, 2 = Max Recall in Effect
 3 = Detector Fail Max Time from By-Phase Timing Data

Detector Diagnostic Intervals

Diagnostic Number	*No-Activity Diagnostic Interval	*Max Presence Diagnostic Interval	Erratic Counts
1	0	0	0
2	0	0	0
3	0	0	0
4	0	0	0
5	0	0	0
6	0	0	0
7	0	0	0
8	0	0	0
9	0	0	0
10	0	0	0
11	0	0	0
12	0	0	0
13	0	0	0
14	0	0	0
15	0	0	0
16	0	0	0
17	0	0	0
18	0	0	0
19	0	0	0
20	0	0	0
21	0	0	0
22	0	0	0
23	0	0	0
24	0	0	0
25	0	0	0
26	0	0	0
27	0	0	0
28	0	0	0
29	0	0	0
30	0	0	0
31	0	0	0
32	0	0	0

*NOTE: Scaling is specified in each detector diagnostic plan.

Speed Detectors

	Local Speed Detector							
One Detector Speed:	1	2	3	4	5	6	7	8
Local Detector Number.	0	0	0	0	0	0	0	0
Vehicle Length	0	0	0	0	0	0	0	0
Loop Length.	0	0	0	0	0	0	0	0
Two Detector Speed:								
Local Detector Number.	0	0	0	0	0	0	0	0
Speed Trap Length.	0	0	0	0	0	0	0	0

	Local Speed Detector							
One Detector Speed:	9	10	11	12	13	14	15	16
Local Detector Number.	0	0	0	0	0	0	0	0
Vehicle Length	0	0	0	0	0	0	0	0
Loop Length.	0	0	0	0	0	0	0	0
Two Detector Speed:								
Local Detector Number.	0	0	0	0	0	0	0	0
Speed Trap Length.	0	0	0	0	0	0	0	0

Units. Inches

NOTE: Speed Detector 1 = STA, Speed Detector 2 = STB

Coordinator Manual Command and Options

```

-----
Manual Enable . . . . . Pattern . . . . . 0

Split Units . . . . . Seconds          OffsetUnits . . . . . Seconds
Interconnect Format . STD              Interconnect Source . TLM
Transition. . . . . SMOOTH            Dwell Period. . . . . 0
Resync Count. . . . . 0

```

```

Actuated Coord Phase . . . X Actuated Walk Rest . . . .
Inhibit Max Timing . . . . X Max 2 Select . . . . .
Floating Force Off . . . . . Multisync. . . . .

```

			Phase											
Split Demand:	Call Time	Cyc Count	1	2	3	4	5	6	7	8	9	10	11	12
Demand 1 . .	0	0
Demand 2 . .	0	0

			Phase											
			1	2	3	4	5	6	7	8	9	10	11	12
Auto Permissive Min Green .			0	0	0	0	0	0	0	0	0	0	0	0
Free Alternate Sequence . .			A	B	C	D	E	F						

Coordination Patterns

Preemptors

Preemptor 1

Active	Det Lock.	Ped Dark
Priority Preemption.	Yel-Red To Grn.	Ped Active
Outputs Only During Hold	Flash All Outputs	Zero Ped Clr Time.
Terminate Overlap ASAP	Terminate Phases.	Ped Clr Thru Yel
Don't Override Flash	Duration Time.	0
Flash During Hold.	Delay Time	0
No CVM in Flash.	Inhibit Time	0
Fast Flash Grn on Hold Phase.	Min Ped Clear.	0
Enable Max Time.	Max Time	0
	Exit Max	0
	Min Hold Time.	0
	Hold Delay Time.	0

	Green	Yellow	Red
Minimum	0	0.0	0.0
Track Clear	0	0.0	0.0
Hold.		0.0	0.0

	Phase/Overlap	1	2	3	4	5	6	7	8	9	10	11	12/	A	B	C	D
Terminate Overlap
Track Clearance Phase
Hold Phases
Exit Phases
Exit Calls on Phase

Out of Flash Color for Exit Phases Green

Preemptor 2

Active	Det Lock.	Ped Dark
Priority Preemption.	Yel-Red To Grn.	Ped Active
Outputs Only During Hold	Flash All Outputs	Zero Ped Clr Time.
Terminate Overlap ASAP	Terminate Phases.	Ped Clr Thru Yel
Don't Override Flash	Duration Time.	0
Flash During Hold.	Delay Time	0
No CVM in Flash.	Inhibit Time	0
Fast Flash Grn on Hold Phase.	Min Ped Clear.	0
Enable Max Time.	Max Time	0
	Exit Max	0
	Min Hold Time.	0
	Hold Delay Time.	0

	Green	Yellow	Red
Minimum	0	0.0	0.0
Track Clear	0	0.0	0.0
Hold.		0.0	0.0

	Phase/Overlap	1	2	3	4	5	6	7	8	9	10	11	12/	A	B	C	D
Terminate Overlap
Track Clearance Phase
Hold Phases
Exit Phases
Exit Calls on Phase

Out of Flash Color for Exit Phases Green

Linked Preemptor 0

Preemptors

Preemptor 5

```

Active . . . . . X Det Lock. . . . . Ped Dark . . . . .
Priority Preemption. . . . . Yel-Red To Grn. . . . . Ped Active . . . . .
Outputs Only During Hold . . . . . Flash All Outputs . . . . . Zero Ped Clr Time. X
Terminate Overlap ASAP . . . . . Terminate Phases. . . . . Ped Clr Thru Yel . .
Don't Override Flash . . . . . Duration Time. . . . . 0
Flash During Hold. . . . . Delay Time . . . . . 0
No CVM in Flash. . . . . Inhibit Time . . . . . 0
Fast Flash Grn on Hold Phase. . . . . Min Ped Clear. . . . . 0
Enable Max Time. . . . . Max Time . . . . . 0
                               Exit Max . . . . . 0
                               Min Hold Time. . . . . 10
                               Hold Delay Time. . . . . 0

```

```

                               Green      Yellow      Red
Minimum . . . . .      0          0.0        0.0
Track Clear . . . . .      0          0.0        0.0
Hold. . . . .          0.0        0.0

```

```

Phase/Overlap 1 2 3 4 5 6 7 8 9 10 11 12/ A B C D
Terminate Overlap . . . . . . . . . . . . . . . . . . . . . . . . . . . .
Track Clearance Phase . . . . . . . . . . . . . . . . . . . . . . . . . .
Hold Phases . . . . . . . . . . . . . . . . . . . . . . . . . . . . . . X
Exit Phases . . . . . . . . . . . . . . . . . . . . . . . . . . . . . . .
Exit Calls on Phase . . . . . . . . . . . . . . . . . . . . . . . . . . . .

```

```

Out of Flash Color for Exit Phases . . . . . Green
Linked Preemptor . . . . . 0

```

Preemptor 6

```

Active . . . . . X Det Lock. . . . . Ped Dark . . . . .
Priority Preemption. . . . . Yel-Red To Grn. . . . . Ped Active . . . . .
Outputs Only During Hold . . . . . Flash All Outputs . . . . . Zero Ped Clr Time. .
Terminate Overlap ASAP . . . . . Terminate Phases. . . . . Ped Clr Thru Yel . .
Don't Override Flash . . . . . Duration Time. . . . . 0
Flash During Hold. . . . . Delay Time . . . . . 0
No CVM in Flash. . . . . Inhibit Time . . . . . 0
Fast Flash Grn on Hold Phase. . . . . Min Ped Clear. . . . . 0
Enable Max Time. . . . . Max Time . . . . . 0
                               Exit Max . . . . . 0
                               Min Hold Time. . . . . 10
                               Hold Delay Time. . . . . 0

```

```

                               Green      Yellow      Red
Minimum . . . . .      0          0.0        0.0
Track Clear . . . . .      0          0.0        0.0
Hold. . . . .          0.0        0.0

```

```

Phase/Overlap 1 2 3 4 5 6 7 8 9 10 11 12/ A B C D
Terminate Overlap . . . . . . . . . . . . . . . . . . . . . . . . . . . .
Track Clearance Phase . . . . . . . . . . . . . . . . . . . . . . . . . .
Hold Phases . . . . . . . . . . . . . . . . . . . . . . . . . . . . . . X
Exit Phases . . . . . . . . . . . . . . . . . . . . . . . . . . . . . . .
Exit Calls on Phase . . . . . . . . . . . . . . . . . . . . . . . . . . . .

```

```

Out of Flash Color for Exit Phases . . . . . Green
Linked Preemptor . . . . . 0

```

NIC/TOD Clock/Calendar

Manual NIC Program Step 0

Manual TOD Program Step 0

NIC Resync Time 0300

Sync Reference is Last Event

Week 1 Begins on 1st Sunday NO If NO, then week containing Jan. 1

Disable Daylight Savings Time NO

Daylight Savings

Begins Last Sunday in March NO If NO, then Second Sunday as per 2007 DST Law

TOD Weekly/Yearly

	Weekly Program Numbers										Program No.	
	1	2	3	4	5	6	7	8	9	10		
Sunday . . .	2	1	1	1	1	1	1	1	1	1	1	Program No.
Monday . . .	1	1	1	1	1	1	1	1	1	1	1	Program No.
Tuesday . . .	1	1	1	1	1	1	1	1	1	1	1	Program No.
Wednesday . .	1	1	1	1	1	1	1	1	1	1	1	Program No.
Thursday . . .	1	1	1	1	1	1	1	1	1	1	1	Program No.
Friday . . .	1	1	1	1	1	1	1	1	1	1	1	Program No.
Saturday . . .	2	1	1	1	1	1	1	1	1	1	1	Program No.

Prog	Week of Year																	
	1	2	3	4	5	6	7	8	9	10	11	12	13	14	15	16	17	18
Prog	1	1	1	1	1	1	1	1	1	1	1	1	1	1	1	1	1	1
Prog	19	20	21	22	23	24	25	26	27	28	29	30	31	32	33	34	35	36
Prog	37	38	39	40	41	42	43	44	45	46	47	48	49	50	51	52	53	

Holiday Programs

Holiday	Type	Month	Day of Week/ Day of Month	Week of Year/ Year	Program
1	Fixed	0	0	0	0
2	Fixed	0	0	0	0
3	Fixed	0	0	0	0
4	Fixed	0	0	0	0
5	Fixed	0	0	0	0
6	Fixed	0	0	0	0
7	Fixed	0	0	0	0
8	Fixed	0	0	0	0
9	Fixed	0	0	0	0
10	Fixed	0	0	0	0
11	Fixed	0	0	0	0
12	Fixed	0	0	0	0
13	Fixed	0	0	0	0
14	Fixed	0	0	0	0
15	Fixed	0	0	0	0
16	Fixed	0	0	0	0
17	Fixed	0	0	0	0
18	Fixed	0	0	0	0
19	Fixed	0	0	0	0
20	Fixed	0	0	0	0
21	Fixed	0	0	0	0
22	Fixed	0	0	0	0
23	Fixed	0	0	0	0
24	Fixed	0	0	0	0
25	Fixed	0	0	0	0
26	Fixed	0	0	0	0
27	Fixed	0	0	0	0
28	Fixed	0	0	0	0
29	Fixed	0	0	0	0
30	Fixed	0	0	0	0
31	Fixed	0	0	0	0
32	Fixed	0	0	0	0
33	Fixed	0	0	0	0
34	Fixed	0	0	0	0
35	Fixed	0	0	0	0
36	Fixed	0	0	0	0

NIC Program Steps

Step	Program	Step Begins	Pattern	Override
------	---------	-------------	---------	----------

TOD Program Steps
