



# HEXAGON TRANSPORTATION CONSULTANTS, INC.

## Memorandum

---

Date: May 11, 2021

To: Mr. Steven Chang, City of Hayward Public Works-Transportation

From: Brett Walinski, T.E.  
Eric Tse, P.E.

Subject: Traffic Operations Report for Mission Village Retail Development (City of Hayward Planning Application #202101267)

---

## Introduction

Hexagon Transportation Consultants, Inc. has completed this traffic operations analysis for the proposed coffee shop and retail development located at 29827 Mission Boulevard just south of Industrial Parkway in Hayward, California. The existing site is occupied by a vacant bowling alley and partially occupied shopping center which is currently closed.

A transportation impact study for a previously approved mixed-use project, which consisted of 72 townhomes, a 5,000 square-foot shopping center, and a 3,000 square-foot restaurant for the subject site was completed in 2016. Since that time, the project has been updated to convert the retail pad into a 2,500 square foot Starbucks coffee shop with a drive-through and a retail store of 3,700 square feet. The purpose of this study is to update the prior 2016 transportation analysis as a result of the proposed change in the retail pad only. The previously approved project was assumed to be part of the background conditions in this study.

Access to the retail pad would be provided primarily via one shared driveway on Industrial Parkway and another shared driveway on Mission Boulevard, but retail users could also use additional project driveways on Mission Boulevard and Industrial Parkway, which can be accessed through the adjacent, previously approved, residential development. The project location and study intersections are shown on Figure 1.

## Scope of Study

Senate Bill (SB) 743 has changed the primary metric for identifying transportation impacts under CEQA from vehicle level of service (LOS) to daily vehicle miles travelled (VMT). The City of Hayward's VMT analysis policy is described in the City Transportation Impact Analysis Guidelines dated December 2020. Because the project would have less than 50,000 square feet of retail space and its uses would be local-serving, the project's impacts on VMT are considered *less than significant* in accordance with the City VMT analysis guidelines and consistent with the Governor's Office of Planning and Research (OPR) *Technical Advisory* dated December 2018.

*"By adding retail opportunities into the urban fabric and thereby improving retail destination proximity, local-serving retail development tends to shorten trips and reduce VMT. Thus, lead agencies generally may presume such development creates a less-than-significant transportation impact."*

The transportation study also includes an analysis of the operations at the site driveways and at key intersections and roadways around the site. The traffic study includes an analysis of AM and PM peak hour traffic conditions at four signalized intersections. The study intersections are identified below.

Mission Village Retail Developments

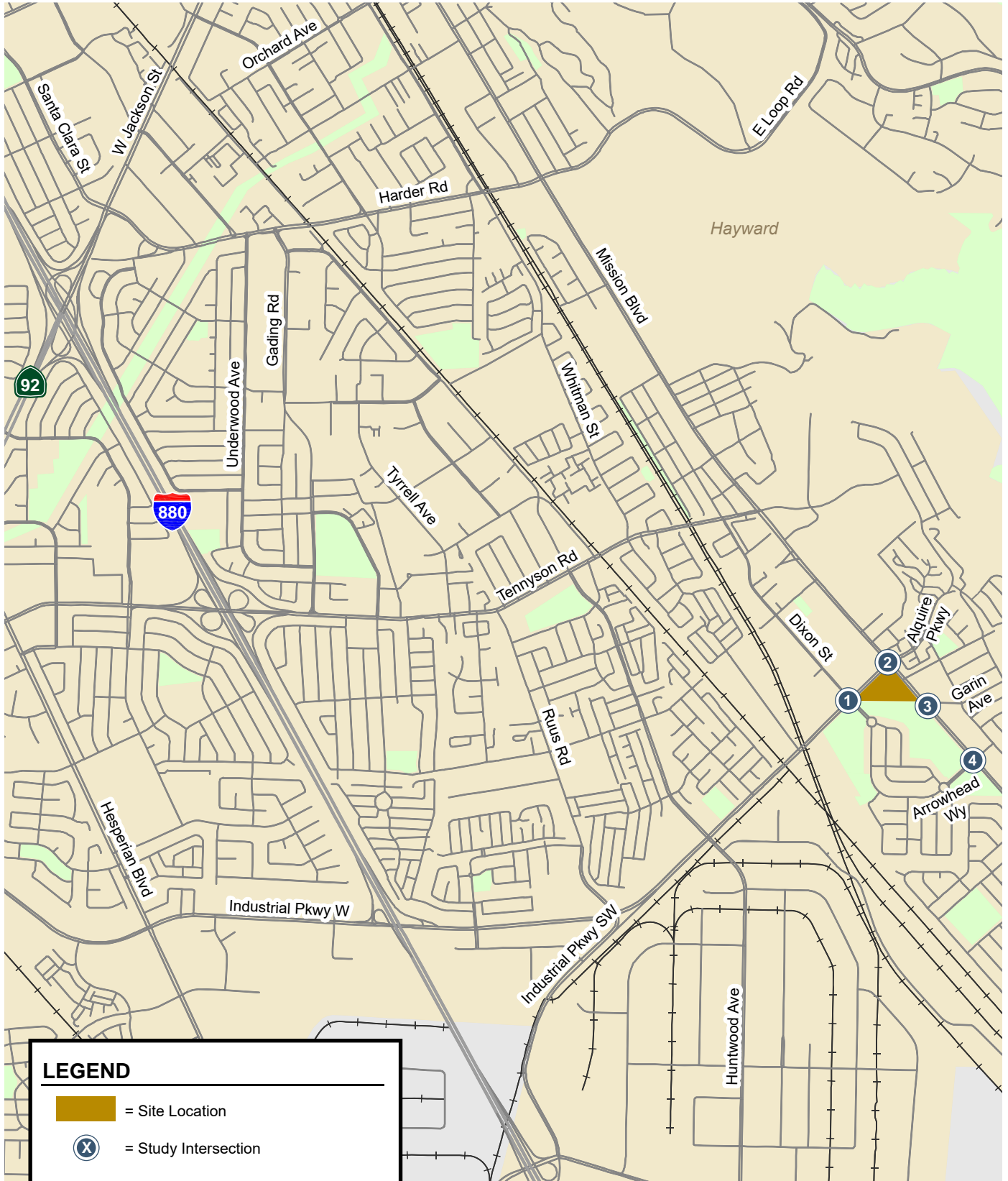

Figure 1  
Site Location

## Mission Village Retail Development

1. Dixon Street/Arrowhead Way and Industrial Parkway
2. Mission Boulevard and Industrial Parkway
3. Mission Boulevard and Garin Avenue
4. Mission Boulevard and Arrowhead Way

Traffic conditions at the study intersections were analyzed for the weekday AM and PM peak hours of traffic. The AM peak hour is typically between 7:00 and 9:00 AM and the PM peak hour is typically between 4:00 and 6:00 PM. It is during these periods that the most congested traffic conditions occur on an average day. The operations of the study intersections were evaluated for the following scenarios:

- Scenario 1:** *Existing Conditions.* Existing traffic volumes for the study intersections are based on traffic counts collected in November 2015 and adjusted to Year 2020 by an annual growth rate of one percent, which was estimated from the City of Hayward General Plan EIR.
- Scenario 2:** *Background Conditions.* Background traffic volumes represents existing traffic volumes plus trips generated by the approved development projects in the project vicinity. Traffic generated from the adjacent townhouse project and prior retail was added as an approved development.
- Scenario 3:** *Background plus Project Conditions.* Background plus project conditions were estimated by adding the traffic generated by the project to the background traffic volumes. Pass-by trips from the retail development were assigned to and from Mission Boulevard and Industrial Parkway to account for trips that already exist on the roadway network but would stop at the project site on route to another destination. Background plus project conditions were evaluated relative to background without project conditions.

The potential adverse effects related to the proposed development were evaluated following the standards and methodologies set forth by the City of Hayward. Intersection operations were evaluated using the Highway Capacity Manual (HCM) level of service methodology for signalized intersections during the peak hours. Vehicle queuing was evaluated for:

- Northbound left-turn from Mission Boulevard to Industrial Parkway
- Southbound U and left-turns from Mission Boulevard to Garin Avenue

The project's site access and circulation elements were also evaluated.

## Existing Transportation Setting

### Roadways

Regional and local access to the site is provided by Mission Boulevard (State Route 238), Industrial Parkway, Dixon Street, Arrowhead Way, and Garin Avenue. These roadways are described below.

**Mission Boulevard, State Route 238,** is a four- to six-lane, north-south, major arterial that extends from I-238 in Hayward to I-880 in south Fremont. The section of Mission Boulevard within the study area varies between four and six lanes wide and provides direct access to the site.

**Industrial Parkway** is a four-lane, east-west, major arterial that extends west from Mission Boulevard before it splits west of Huntwood Avenue, the northern branch becoming Industrial Parkway W, and the southern branch becoming Industrial Parkway SW.

**Dixon Street** is a two-lane, north-south, residential street that extends from Industrial Parkway to Tennyson Road where it becomes E 12<sup>th</sup> Street.

## Mission Village Retail Development

**Arrowhead Way** is a two-lane, winding, residential street that extends from Industrial Parkway, where it is a north-south street, to Mission Boulevard, where it is an east-west street.

**Garin Avenue** is a two-lane, east-west, residential street that extends from Mission Boulevard east toward the foothills, providing access to Garin Regional Park of the East Bay Regional Park District.

### Bicycle and Pedestrian Facilities

There are bicycle facilities in the vicinity of the site. There is an existing Class I bike path parallel to Mission Boulevard along the west side from Garin Avenue to Arrowhead Way and beyond to Fairview Street. There are existing Class II bike lanes on Dixon Street between Industrial Parkway to Tennyson Road and on Alquire Parkway east of Mission Boulevard. Garin Avenue is an existing Class III bicycle route east of Mission Boulevard. Mission Boulevard has existing Class IV separated bike lanes in both directions south of Industrial Parkway.

Existing pedestrian facilities in the project area consist of sidewalks and crosswalks found along all previously-described roadways in the study area near the site. All study intersections have pedestrian crosswalks and curb ramps. All signalized intersections have pedestrian-actuated pedestrian-crossing phases.

### Transit service

Existing transit service in the area includes Alameda-Contra Costa (AC) Transit bus lines 99 and 801. Line 99 connects the Bayfair BART station with the Fremont BART station via Mission Boulevard, with 20-minute headways between approximately 5:00 AM and 12:45 AM on weekdays. Line 99 also provides weekend service. Line 801 provides all-night service between downtown Oakland and the Fremont BART station via Mission Boulevard every hour between approximately 11:00 PM and 5:00 AM on weekdays. Line 801 also provides weekend service. Both lines have stops on Mission Boulevard at Industrial Parkway. The South Hayward BART station is located two-thirds of a mile north of the site just off of Dixon Street. The nearest bus stops for Lines 99 and 801 are located at the southwest and northeast corners of the Mission Boulevard/Industrial Parkway intersection within walking distance to the project site.

### Existing Intersection Geometry and Traffic Volumes

The existing intersection lane configurations are shown on Figure 2. Existing traffic volumes were obtained from peak-hour counts conducted in 2015, and due to Covid 19 shelter-in-place orders, were adjusted to Year 2020 using a one-percent growth factor. This growth factor was derived from City of Hayward General Plan forecasts. Existing traffic volumes are shown on Figure 3. The count data are included in Appendix A.

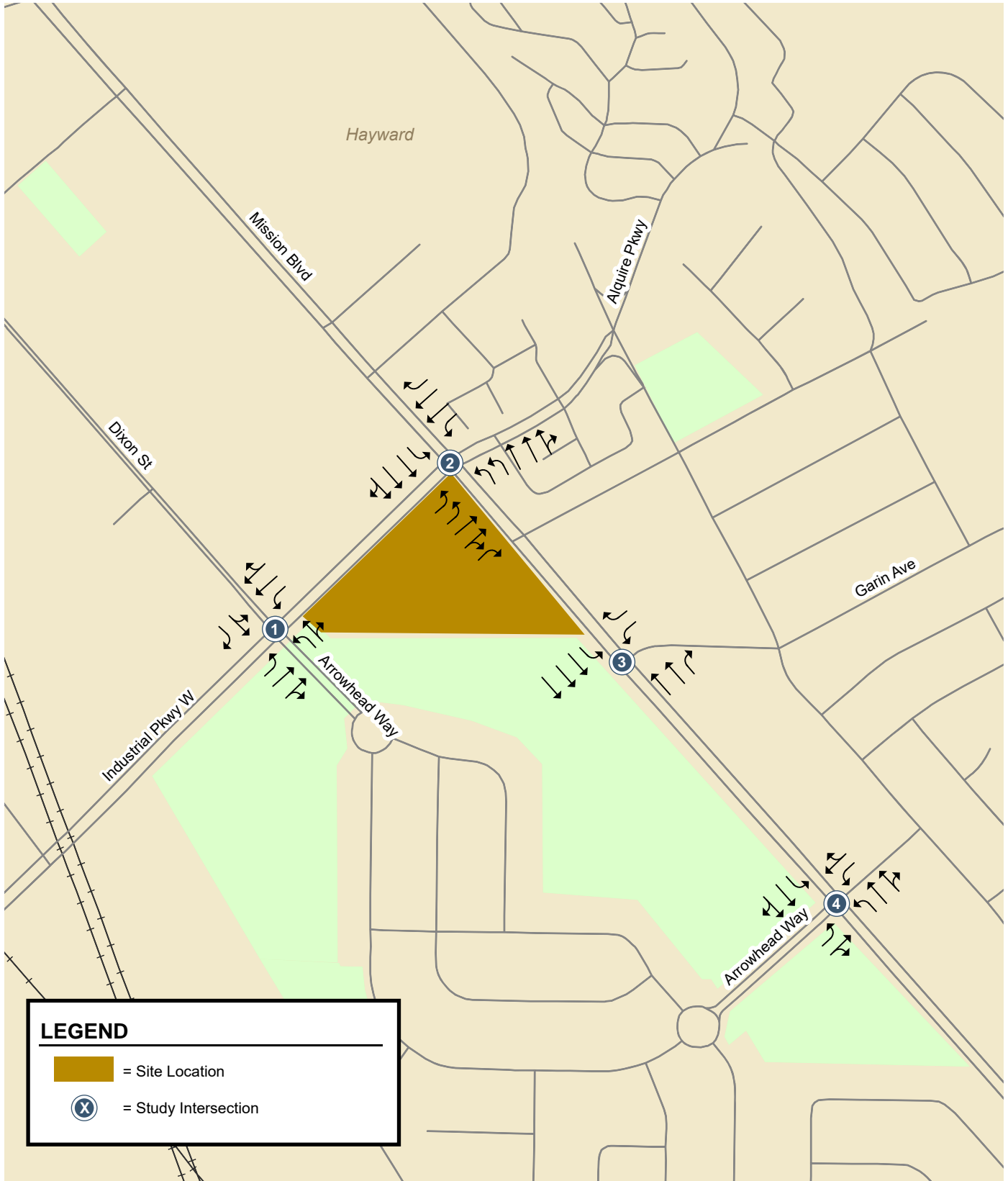
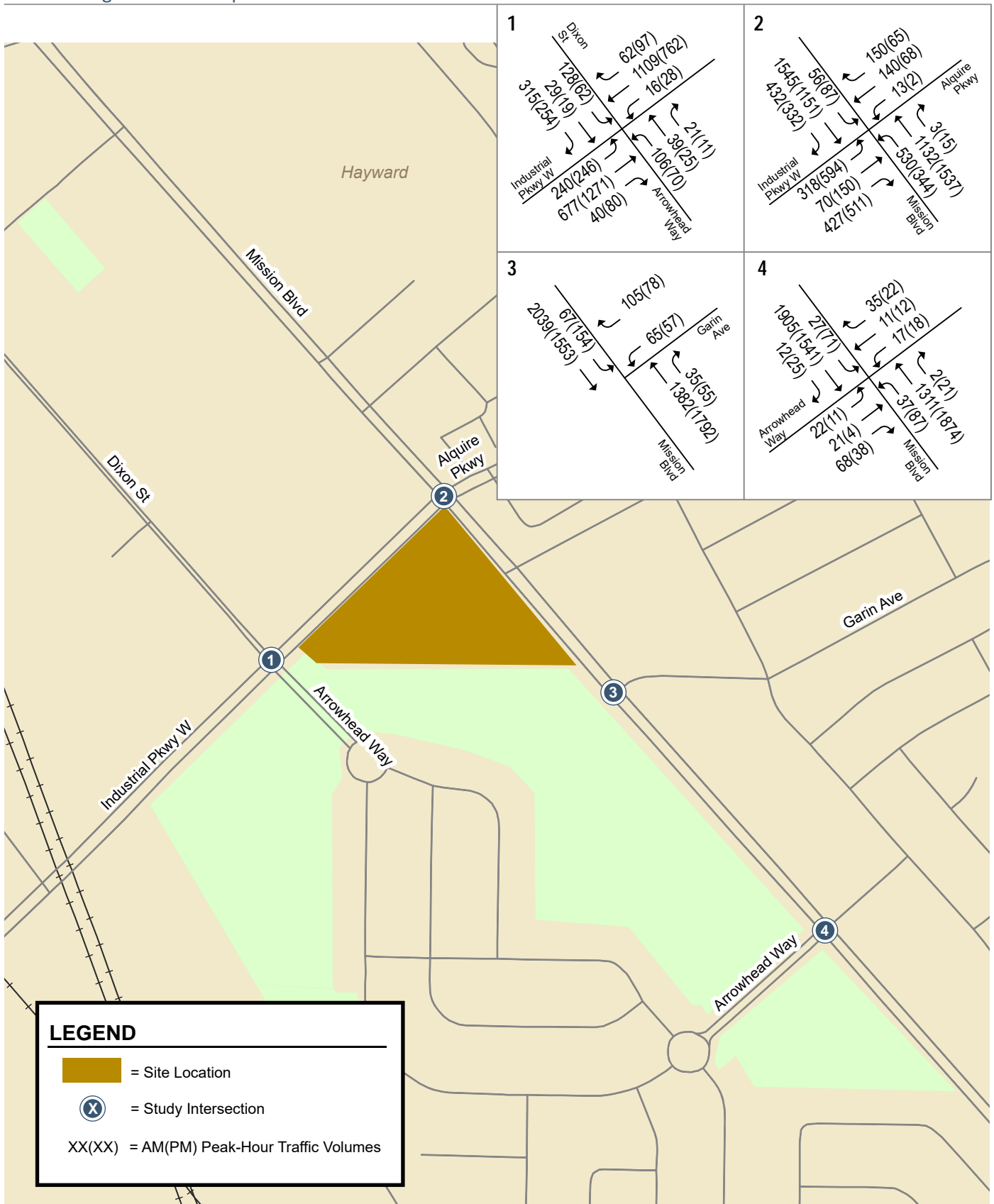

Figure 2  
Existing Lane Configurations



Mission Village Retail Developments



**Figure 3**  
Existing Traffic Volumes

## Mission Village Retail Development

**Existing Intersection Analysis**

Traffic operations at the study intersections were evaluated using Synchro software to determine level of service for the AM and PM peak hours. The results show that all of the study intersections currently operate at acceptable level of service (LOS) D or better during the AM and PM peak hours. The results of the intersection level of service analysis under existing conditions are summarized in Table 1. The levels of service calculation sheets are included in the Appendix.

**Table 1**  
**Existing Intersection Levels of Service**

Study No.	Intersection Name	Peak Hour	Avg. Delay	V/C	LOS
1	Dixon St & Industrial Pkwy	AM	24.0	0.81	C
		PM	16.4	0.74	B
2	Mission Blvd & Industrial Pkwy	AM	41.3	0.87	D
		PM	34.7	0.77	C
3	Mission Blvd & Garin Ave	AM	7.3	0.63	A
		PM	16.0	0.85	B
4	Mission Blvd & Arrowhead Way	AM	10.7	0.76	B
		PM	12.0	0.79	B

Signalized intersection level of service is based on the *Highway Capacity Manual (HCM)* methodology, using average control delay for the entire intersection.

**Project Traffic Estimates**

Through empirical research, data have been collected that correlate to common land uses their propensity for producing traffic. Thus, for the most common land uses there are standard trip generation rates that can be applied to help predict the future traffic increases that would result from a new development. The magnitude of traffic added to the roadway system by a particular development is estimated by multiplying the applicable trip generation rates to the size of the development. The standard trip generation rates are published in the Institute of Transportation Engineers (ITE) manual entitled *Trip Generation*, 10th Edition.

It is anticipated that both the Starbucks coffee shop and retail component of the project would generate pass-by trips. Pass-by trips are trips that would already be on the adjacent roadways (and are therefore already counted in the existing traffic), but would turn into the site while passing by. Justification for applying the pass-by trip reduction is founded on the observation that such traffic is not actually generated by the proposed development but is already part of the ambient traffic levels. An internal capture reduction of 20 percent was applied to the AM and PM peak hour trip generation to account for trips made internally between the project and the adjacent residential uses. A pass-by trip reduction of 42 percent was applied to the AM and PM peak hour trip generation for Starbucks, consistent with industry-standard methodologies and historical trip characteristics for similar projects along Mission Boulevard provided by City staff. Pass-by trips were assumed to originate on Mission Boulevard and Industrial Parkway and were assigned at the intersections of Mission Boulevard/Industrial Parkway and Mission Boulevard/Garin Avenue.

The project also receives trip credits for the previously approved retail and restaurant development<sup>1</sup> at the project site. The net trip generation estimates are shown in Table 2.

<sup>1</sup> Refer to Traffic Operations Report for 29827 Mission Boulevard Mixed-Use Development by Hexagon dated January 12, 2016

Mission Village Retail Development

**Table 2  
Project Trip Generation Estimates**

Land Use	Size	Daily Rate <sup>1</sup>	Daily Trips	AM Peak Hour			PM Peak Hour				
				Rate	Trips	In	Out	Rate	Trips	In	Out
<b>Proposed Use</b>											
Coffee Shop <sup>1</sup>	2,500 sf	820.38	2,051	88.99	222	113	109	43.38	108	54	54
Retail <sup>2</sup>	3,700 sf	37.75	140	0.94	3	2	1	3.81	14	7	7
	Internal Capture <sup>4</sup>	20%	(97)		(8)	(1)	(7)		(9)	(6)	(3)
	Pass by	42%	(879)		(91)	(48)	(43)		(47)	(23)	(24)
	<b>Primary Project Trips</b>		<u>1,214</u>		<u>126</u>	<u>66</u>	<u>60</u>		<u>66</u>	<u>32</u>	<u>34</u>
<b>Previously Approved Use</b>											
Retail <sup>2</sup>	5,000 sf	37.75	(189)	0.94	(5)	(3)	(2)	3.81	(19)	(9)	(10)
Quality Restaurant <sup>3</sup>	3,000 sf	83.84	(252)	0.73	(2)	(2)	0	7.80	(23)	(15)	(8)
	<b>Net Project Trips</b>		<u>774</u>		<u>119</u>	<u>61</u>	<u>58</u>		<u>24</u>	<u>8</u>	<u>16</u>
<sup>1</sup> Rates based on ITE <i>Trip Generation, 10th Edition</i> : average rates for Coffee/Donut Shop with Drive-Through (ITE 937). <sup>2</sup> Rates based on ITE <i>Trip Generation, 10th Edition</i> : average rates for Shopping Center (ITE 820). <sup>3</sup> Rates based on ITE <i>Trip Generation, 10th Edition</i> : average rates for Quality Restaurant (ITE 931). <sup>4</sup> Internal Capture of 20% was applied to the residential component, which is the smaller trip generator of the retail and townhouse components.											

The trip distribution pattern for the proposed project was estimated based on existing travel patterns, the locations of complementary land uses, and the traffic operations study for the previously approved retail. The new peak-hour trips generated by the proposed project (the project trips) were added to the roadway network in accordance with the project trip generation and distribution described above. The project trip distribution and net project trip assignment are shown on Figure 4.



Mission Village Retail Developments

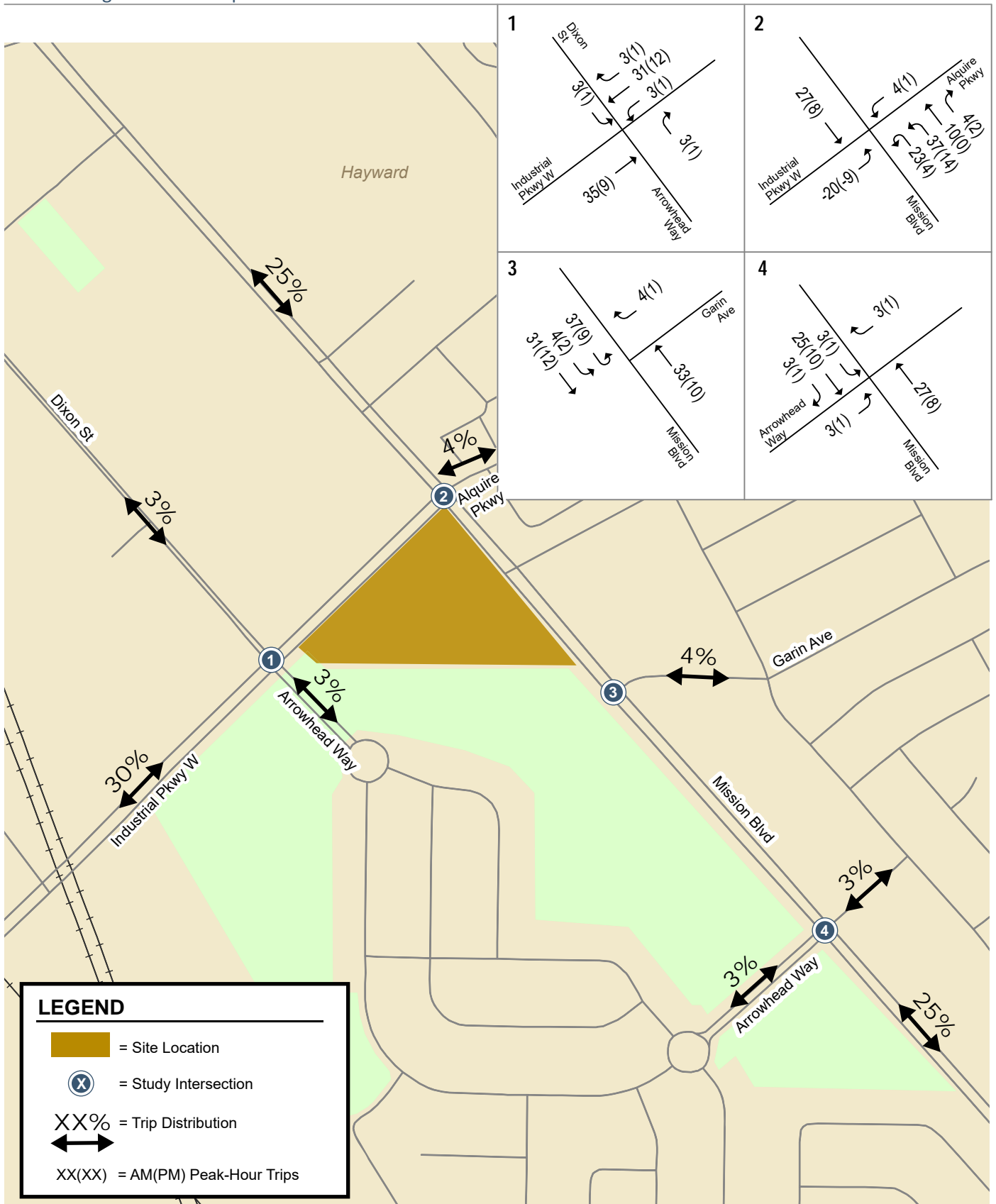

**Figure 4**  
Project Trip Distribution and Net Project Trip Assignment

## Intersection Level of Service Analysis

Traffic operations at the study intersections were evaluated using Synchro software to determine level of service for the AM and PM peak hours under existing, background, and background with proposed project. The Synchro calculation sheets are included in the attached appendix.

Background traffic volumes were estimated by adding traffic generated from the previously approved townhome and retail project to existing traffic. Figure 5 shows the background traffic volumes.

Project trips were added to the background traffic volumes to determine the background with project traffic volumes. Figure 6 shows the background plus project traffic volumes. Background plus project conditions were evaluated relative to background no project conditions. The results show that all of the study intersections would continue to operate at an acceptable LOS D or better during the AM and PM peak hours. The level of service results are summarized in Table 3.

Existing with project conditions are not included in the analysis because the retail development would not be implemented without the previously approved townhouse component, and the background with project conditions covers the overall proposed project, which includes both its retail and residential components.

**Table 3**  
**Background Plus Project Intersection Levels of Service Summary**

Study No.	Intersection Name	Peak Hour	Existing			Background			Background Plus Project		
			Avg. Delay	V/C	LOS	Avg. Delay	V/C	LOS	Avg. Delay	V/C	LOS
1	Dixon St & Industrial Pkwy	AM	24.0	0.81	C	24.5	0.82	C	26.2	0.84	C
		PM	16.4	0.74	B	16.8	0.75	B	17.0	0.75	B
2	Mission Blvd & Industrial Pkwy	AM	41.3	0.87	D	43.6	0.89	D	45.8	0.91	D
		PM	34.7	0.77	C	35.3	0.79	D	35.6	0.79	D
3	Mission Blvd & Garin Ave	AM	7.3	0.63	A	7.3	0.63	A	9.9	0.67	A
		PM	16.0	0.85	B	16.1	0.85	B	17.9	0.86	B
4	Mission Blvd & Arrowhead Way	AM	10.7	0.76	B	10.7	0.76	B	11.6	0.77	B
		PM	12.0	0.79	B	12.0	0.79	B	12.2	0.79	B

Signalized intersection level of service is based on the *Highway Capacity Manual (HCM)* methodology, using average control delay for the entire intersection.

Mission Village Retail Developments

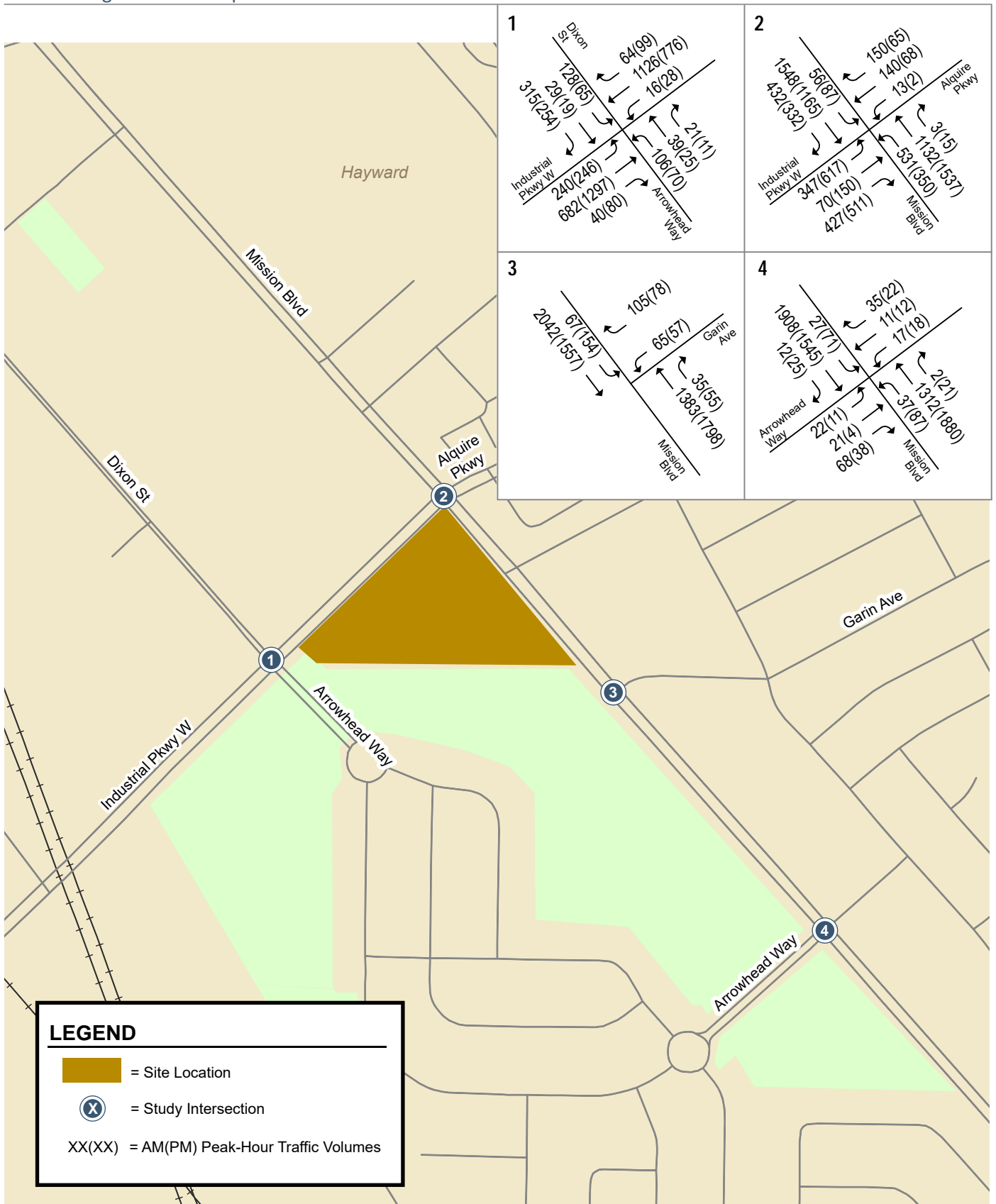

**Figure 5**  
**Background Traffic Volumes**

Mission Village Retail Developments

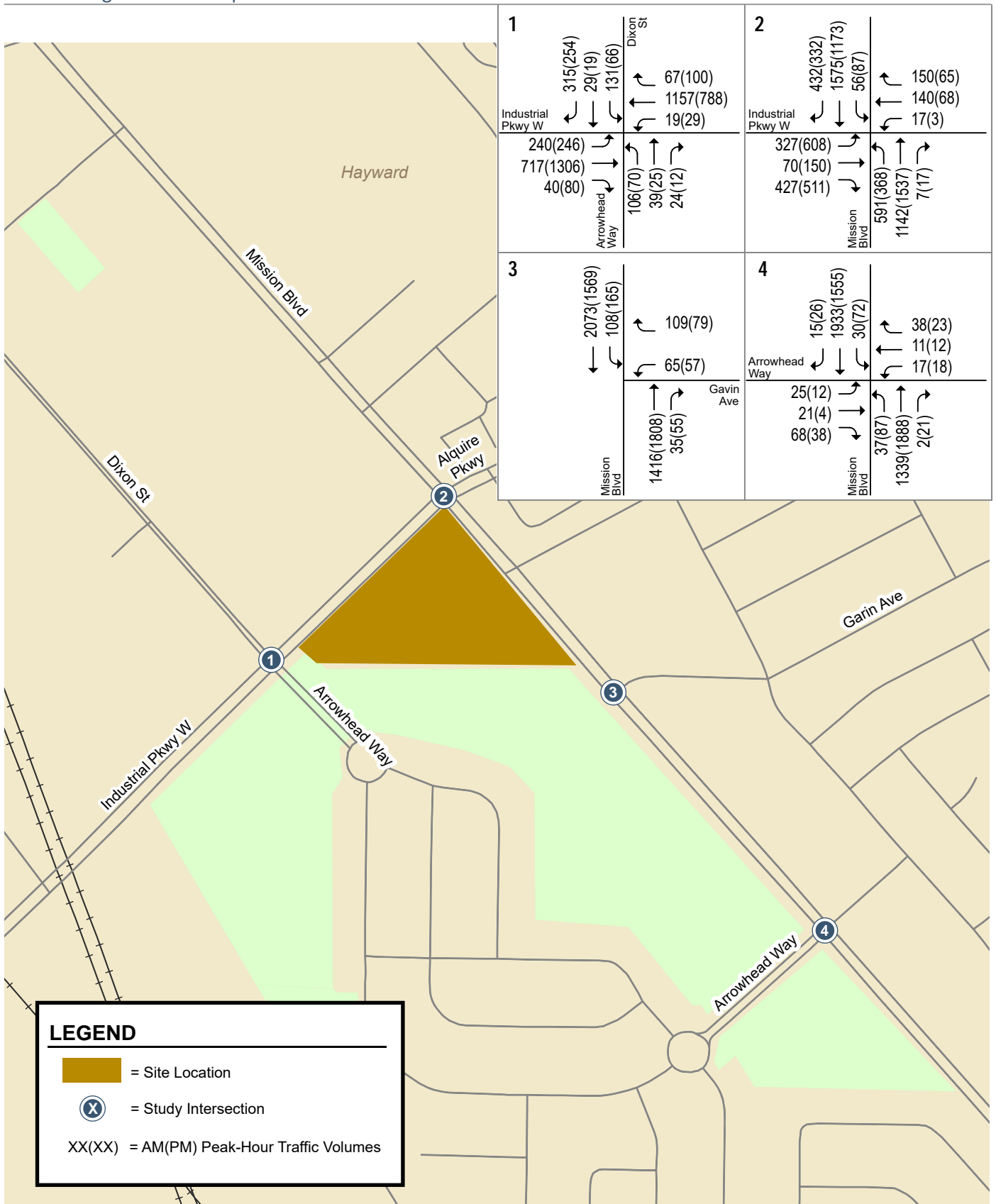

**Figure 6**  
Background Plus Project Traffic Volumes

## Vehicle Queuing Analysis

A vehicle queuing analysis was conducted for the left and U-turn movements where the project would add traffic at the intersections of Mission Boulevard/Industrial Parkway and Mission Boulevard/Garin Avenue. Vehicle queues were estimated using a Poisson probability distribution. The basis of the analysis is as follows: (1) the Poisson probability distribution is used to estimate the 95<sup>th</sup> percentile maximum number of queued vehicles per signal cycle for a particular movement; (2) the estimated maximum number of vehicles in the queue is translated into a queue length, assuming 25 feet per vehicle; and (3) the estimated maximum queue length is compared to the existing or planned available storage capacity for the movement. This analysis thus provides a basis for estimating future storage requirements at intersections. The vehicle queuing estimates and a tabulated summary of the findings for the study intersections are provided in Table 4. The analysis indicates that, with the addition of project traffic, the 95<sup>th</sup> percentile vehicle queues could be accommodated by the existing storage provided at all study locations during the AM and PM peak hours.

**Table 4  
Vehicle Queuing Analysis Summary**

	Mission Blvd. and Industrial Pkwy NB Left Turn	Mission Blvd. and Garin Ave SB Left Turn
<b>Measurement</b>		
<b><u>Background (AM)</u></b>		
Cycle/Delay <sup>1</sup> (sec)	130	90
Volume (vph)	531	67
Avg. Queue (veh)	19.2	1.7
Avg. Queue (ft.) <sup>2</sup>	479	42
95th % . Queue (veh)	27	4
95th % . Queue (ft.) <sup>2</sup>	675	100
Storage	850	200
Adequate (Y/N)	Y	Y
<b><u>Background (PM)</u></b>		
Cycle/Delay <sup>1</sup> (sec)	130	90
Volume (vph)	350	154
Avg. Queue (veh)	12.6	3.9
Avg. Queue (ft.) <sup>2</sup>	316	96
95th % . Queue (veh)	19	7
95th % . Queue (ft.) <sup>2</sup>	475	175
Storage	850	200
Adequate (Y/N)	Y	Y
<b><u>Background + Project (AM)</u></b>		
Cycle/Delay <sup>1</sup> (sec)	130	90
Volume (vph)	591	108
Avg. Queue (veh)	21.3	2.7
Avg. Queue (ft.) <sup>2</sup>	534	68
95th % . Queue (veh)	29	6
95th % . Queue (ft.) <sup>2</sup>	725	150
Storage	850	200
Adequate (Y/N)	Y	Y
<b><u>Background + Project (PM)</u></b>		
Cycle/Delay <sup>1</sup> (sec)	130	90
Volume (vph)	368	165
Avg. Queue (veh)	13.3	4.1
Avg. Queue (ft.) <sup>2</sup>	332	103
95th % . Queue (veh)	20	8
95th % . Queue (ft.) <sup>2</sup>	500	200
Storage	850	200
Adequate (Y/N)	Y	Y
<sup>1</sup> Vehicle queue calculations based on signal cycle length for signalized intersections		
<sup>2</sup> Assumes 25 feet per vehicle queued		

## Site Access, On-Site Circulation

This section describes the site access and on-site circulation for the proposed changes to the retail portion of the project. This review is based on the project site plan provided by the applicant (See Figure 7).

### *Site Access and Project Driveways*

Primary access to the retail portion of project site would be provided via (1) Industrial Parkway at Driveway A and (2) Mission Boulevard at Driveway B. Both site driveways would also allow access to/from the adjacent townhome development. Project traffic would also have access to/from other driveways, which are not gated, on Industrial Parkway and Mission Boulevard, that would serve the adjacent planned townhomes (see Figure 8). Traffic operations at the primary retail driveways were evaluated using Synchro traffic analysis software based on the project trip assignment at the driveways, using queuing and delay. The project trip assignment at the primary retail driveways is shown on Figure 7.

Driveway A is the site driveway on Industrial Parkway located at approximately 150 feet west of the intersection at Mission Boulevard and Industrial Parkway. It would be an inbound right-in only driveway within the taper of the intersection's eastbound right-turn pocket. This driveway is aligned with a north-south one-way internal drive aisle. There is angled parking on the west side of the drive aisle for the coffee shop and retail store. The angled parking would begin approximately 40 feet from the face of curb on Industrial Parkway. The drive through exit of the coffee shop is connected to this north-south drive aisle. Driveway A is projected to accommodate 43 AM and 20 PM inbound-only peak hour trips. Because this is a right-in only access driveway with no exiting traffic, delay and queuing at the driveway would be minimal. The sight distance at this driveway was also observed in the field and determined to be adequate.

Driveway B is the site driveway on Mission Boulevard located at approximately 170 feet southeast of Industrial Parkway. The driveway will serve inbound and outbound right-turn vehicles from and to Mission Boulevard. There is a median island opposite the driveway that prevents left turns into or out of the driveway. The driveway length is approximately 135 feet to the point where it intersects with an east/west aisle. There is perpendicular parking on both sides of the street for the retail uses. The perpendicular parking would begin approximately 25 feet from the face of curb on Industrial Parkway. Driveway B is projected to accommodate 174 AM peak hour trips (71 inbound/103 outbound) and 93 PM peak hour trips (35 inbound/58 outbound). These include trips generated from the previously approved adjacent townhouse development. Based on the LOS and queuing calculations, the outbound movements from the project driveway would operate at LOS B with a 95<sup>th</sup> percentile queue of 25 feet during both AM and PM peak hours. The sight distance at this driveway was also observed in the field and determined to be adequate.

The driveway has a short clear throat (approximately one vehicle's length), beyond which queued vehicles would block the adjacent drive through and parking stalls. Vehicle queues at this driveway could occasionally exceed one vehicle. However, delays would be relatively brief during the AM and PM peak hours. The on-site queues would generally not interfere with traffic operations at the intersection of Mission Boulevard and Industrial Parkway.



Mission Village Retail Developments

**LEGEND**

 = Speed Hump Recommended

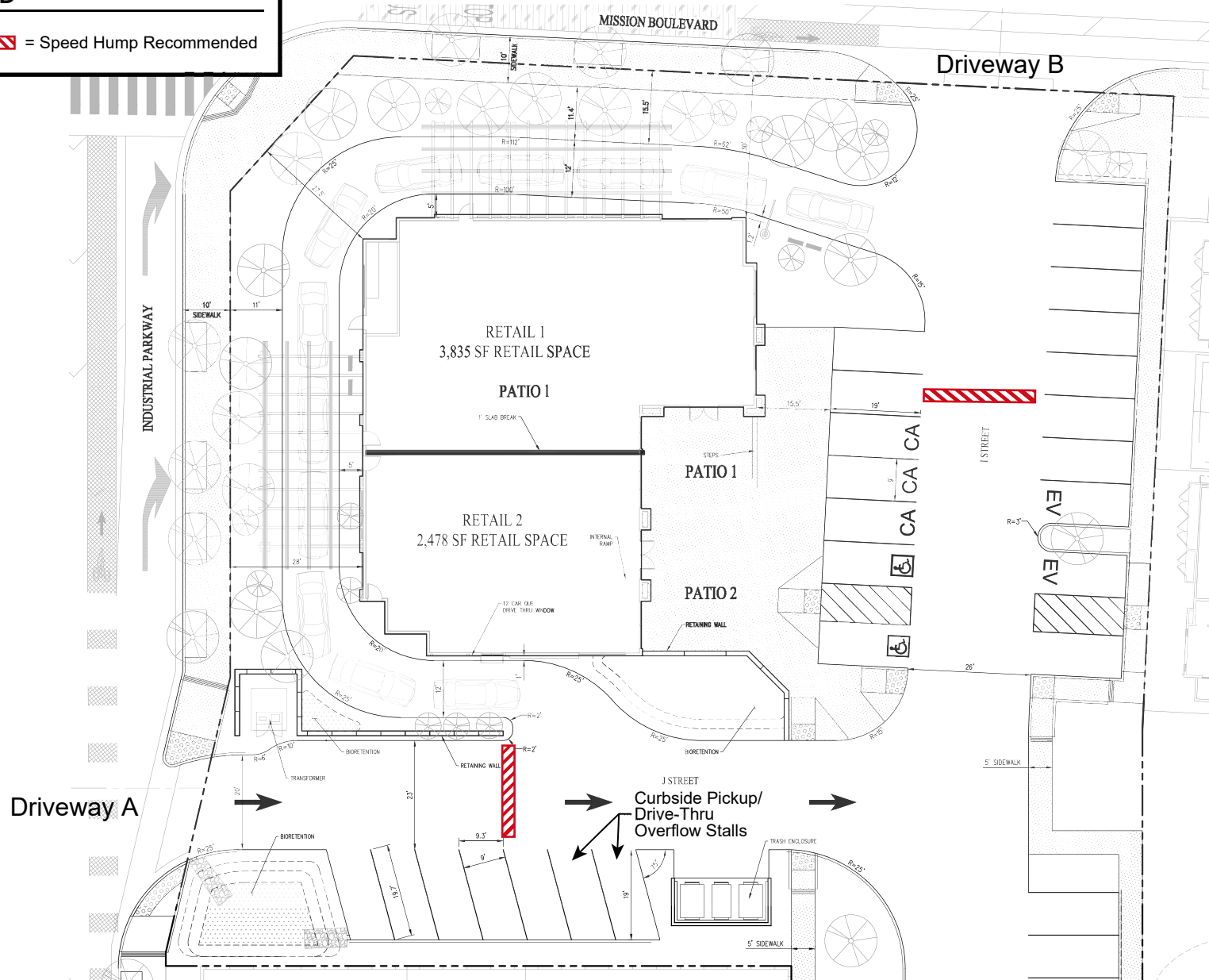

Figure 7  
Project Site Plan

Mission Village Retail Developments

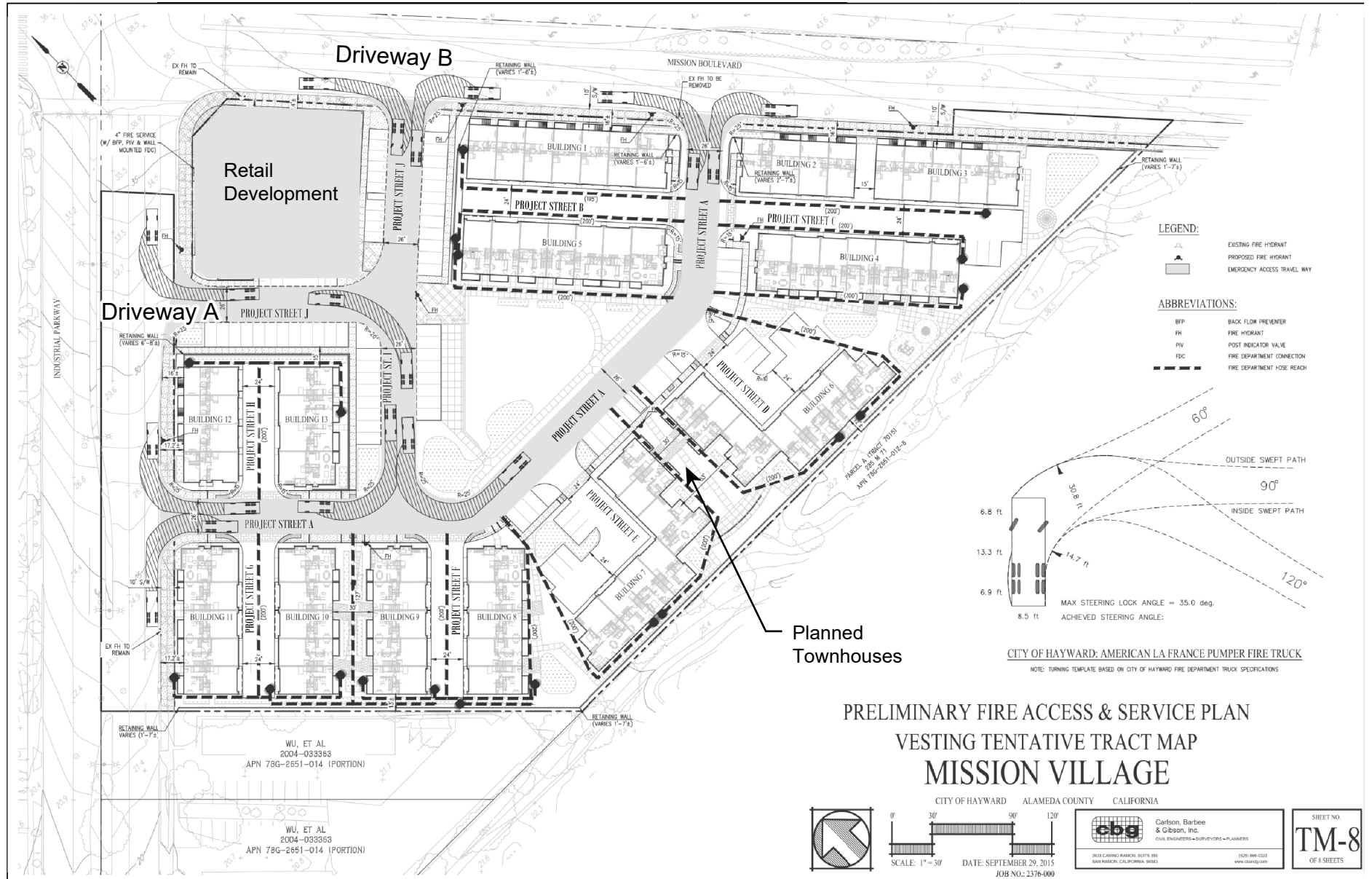

Figure 8  
 Project Site Plan (Overall)

## Site Circulation

The onsite circulation was reviewed in accordance with generally accepted traffic engineering standards. Onsite, angled parking would be provided to the north-south one-way aisle connected to Driveway A and perpendicular parking would be provided to the east-west drive aisle leading to Driveway B. One-way pavement arrows are shown in the north-south one-way drive aisle, indicating the direction of inbound traffic coming from Driveway A.

**Recommendation 1:** To further enhance safety, it is recommended that “Do Not Enter” signs be installed at the southern end of the north-south one-way drive aisle facing traffic the east-west drive aisle in order to deter vehicles from entering the wrong way. In addition, the curb return radius at the northeast corner of the junction should be reduced to make it difficult for vehicles traveling west on the east-west aisle to turn right into on-coming traffic, while still allowing delivery and garbage trucks to turn left from the one-way drive aisle.

The site plan does not include designated loading areas for truck access for the site. Trucks would most likely load and unload in one of the drive aisles in front of the retail building, which would block access to parking stalls and restrict drive aisle operation to one-way. While this is generally undesirable, deliveries and garbage collection occur relatively infrequently, and most often during off peak hours. Due to the location of garbage bins being adjacent to the north-south one-way entry drive aisle, garbage trucks must enter from Driveway A on Industrial Parkway and exit from Driveway B to Mission Boulevard. An analysis using truck turning templates was conducted to determine the adequacy of on-site circulation for the truck category SU 30. Based on the analysis, the parking lot design would be sufficiently wide to serve these types of trucks.

The site plan shows a pedestrian pathway to the project building from Mission Boulevard. Pedestrian access to Industrial Parkway would occur through the adjacent townhomes to the west due to the location of the proposed drive through.

The locations of the two project site driveways and layout of the internal drive aisles would provide continuous connectivity both within the project retail site and with the adjacent townhouse development for vehicular and pedestrian traffic. The access and onsite circulation would also adequately accommodate emergency vehicles.

City parking code specifies a long-term bike parking requirement of 1 space for every 10 parking spaces provided (minimum requirement is 2 spaces) and a short-term bike parking requirement of 20% of required vehicle parking spaces (minimum requirement is 4 spaces). The current site plan does not show provisions for short term or long-term bike parking.

**Recommendation 2:** It is recommended that the project provide two long term and five short term bicycle parking storage onsite consistent with City code requirements.

## Drive-Through Analysis

A queuing analysis was conducted to determine the appropriate storage requirements of the onsite drive-through window. Hexagon conducted queuing observations in February 2016 for a Starbucks drive-through located on Bernal Avenue in Pleasanton, California. The Bernal Avenue location was selected because it has a similar drive through layout as the proposed project site. It is also located in a suburban setting adjacent to a primary arterial. Observations were conducted during peak morning periods from 7:00 AM to 10:00 AM on two typical weekdays and two typical Saturdays. The queues were recorded every minute and measured from the pick-up window back. The results of the surveys were as follows:

Wednesday 2/10: 95<sup>th</sup> Percentile queue = 11 vehicles  
 Tuesday 2/16: 95<sup>th</sup> Percentile queue = 10 vehicles  
 Saturday 2/13: 95<sup>th</sup> Percentile queue = 9 vehicles  
 Saturday 2/6: 95<sup>th</sup> Percentile queue = 12 vehicles

For this analysis, the 95<sup>th</sup> percentile queue is defined as the queue that would be exceeded 5 percent of the time. Based on the surveys, the maximum 95<sup>th</sup> percentile vehicle queue length observed from the pick-up window was 12 vehicles.

## Mission Village Retail Development

The site plan for the proposed Starbucks coffee shop shows that the current design will incorporate one drive-through lane with a total storage of 12 vehicles. Beyond this, vehicles could queue approximately 20 feet onsite (or approximately one additional vehicle) before reaching Mission Boulevard. Two parking stalls across from the drive-through exit would be designated for drive-through overflow/curb side pickup only.

Given the results of the queuing surveys, typical vehicle queues would be mostly contained on the project site. However, there may be short periods where drive through traffic could spill back onto Mission Boulevard. If this were to occur, the vehicles would most likely queue within the existing bicycle lane adjacent to the curb on southbound Mission Boulevard.

In order to minimize the potential for queuing overflow onto the public street network, the project will provide onsite video monitoring and designate staff to direct traffic during busy periods, as needed. If an order were taking too long for a vehicle at the pickup window, and staff sees on the monitoring cameras that the queue length is extending out of the designated drive-through lane, staff could send the vehicle at the window to one of the aforementioned overflow/curb side parking stalls to keep the queue moving forward, and then, bring the order out to the waiting vehicle when ready.

### Neighborhood Cut-Through Traffic

During the AM and PM peak hours, there is high demand for the eastbound Industrial Parkway to southbound Mission Boulevard right turn movement, which sometimes causes right turning traffic at the intersection to experience longer than normal delays. It is anticipated that some of those right turning trips may attempt to use the project driveways to by-pass the congestion at the intersection. Cut-through traffic could potentially block project site parking aisles and driveways, causing site access and internal circulation issues.

**Recommendation 3:** Potential cut-through traffic at the project site should be monitored after project occupancy. If necessary, traffic calming measures such as speed bumps should be considered to discourage cut-through traffic at the project site.

The locations of the speed bumps, as shown in Figure 7, were strategically chosen so that vehicles would slow down before conflict points, such as merges and crosswalks. The speed hump on the east-west aisle coming from Driveway A is located before the drive-through exit in order to slow traffic before the merge. The one on the north-south aisle is located midway between the wheelchair ramps at Driveway B and those near the handicap parking, so that traffic would slow before approaching the ramps.

Since Driveway B is restricted to right-in/right-out movements, traffic exiting from the driveway wishing to turn left onto northbound Mission Boulevard or heading to Industrial Parkway would have to make a U-turn at the Mission Boulevard/Garin Avenue intersection and proceed towards the Industrial Parkway/Mission Boulevard intersection. Similarly, inbound traffic from northbound Mission Boulevard would have to drive past Driveway B (due to the median on Mission Boulevard) and make a U-turn at the Mission Boulevard/Industrial Parkway intersection before turning right onto Driveway B. Alternatively, project traffic destined for or originated from northbound Mission Boulevard could use Carin Avenue and then transverse through neighborhood streets such as Vanderbilt Street and Alquire Parkway to return to northbound Boulevard. Because this cut-through route is circuitous with multiple stop signs, and U-turns are permissible at Garvin Avenue and Industrial Parkway on Mission Boulevard, it is anticipated that only a very small percentage of project traffic would use neighborhood streets during the AM and PM peak hours.

### Impacts to Transit, Bikes, and Pedestrians

Overall, it is anticipated that the volume of pedestrian and bike trips generated by the project would not exceed the carrying capacity of the existing sidewalks, crosswalks, and bike facilities on streets surrounding the site. Alameda County Congestion Management Program (CMP) Transportation Impact Analysis Technical Guidelines state that a project would create an impact on pedestrian and bike circulation if: (1) its vehicle trips would present a barrier to bikes/pedestrians safely crossing roadways, or (2) it would reduce or sever existing or planned bike/pedestrian circulation in the area. Based on these criteria, the proposed project would not create an adverse impact to bike/pedestrian circulation in the area.



## Mission Village Retail Development

According to the U.S. Census, bus trips comprise approximately 2 percent of the total commute mode share in the City of Hayward. For the proposed project, this would equate to four or five new bus riders during peak hours. The volume of bus trips generated by the project would not exceed the carrying capacity of the existing transit serving the site. Therefore, no improvements to existing bus service frequencies would be necessary in conjunction with the proposed project. However, there is an existing bus stop along the project frontage on Mission Boulevard approximately 100 feet south of Industrial Parkway. The stop currently does not include shelters or benches. To improve bus service at the site, the project could consider upgrades to the existing transit stop.

According to the Alameda County Congestion Management Program (CMP) Transportation Impact Analysis Technical Guidelines, a project would create an impact on transit service if: (1) it would cause vehicular congestion that would significantly degrade transit operations, (2) it would cause a ridership increase that would exceed existing transit capacity, or (3) it would conflict with existing transit service plans or preclude future transit service to the project area. Based on these criteria, the proposed project would not cause a significant impact to transit operations in the study area.

## Conclusions

The impacts of the proposed project were evaluated in accordance with the procedures and guidelines specified by the City of Hayward. The analysis resulted in the following key findings:

- A VMT review was conducted to assess the potential impacts caused by the proposed project. Because the project is considered to be local-serving retail, it is anticipated that the project's VMT impact would be *less than significant*.
- Under existing, background, and background plus project, all of the study intersections would operate at an acceptable LOS during the AM and PM peak hours per City LOS standards.

The analysis also produced the following recommendations:

- "Do Not Enter" signs should be installed at the southern end of the north-south one-way drive aisle facing traffic the east-west drive aisle in order to deter vehicles from entering the wrong way. In addition, the curb return radius at the northeast corner of the junction should be reduced to make it difficult for vehicles traveling west on the east-west aisle to turn right into on-coming traffic, while still allowing delivery and garbage trucks to turn left from the one-way drive aisle.
- The project should provide two long term and five short term bicycle parking storage onsite consistent with City code requirements.
- Potential cut-through traffic at the project site should be monitored after project occupancy. If necessary, traffic calming measures such as speed bumps should be considered to discourage cut-through traffic at the project site.

In order to minimize the potential for queuing overflow onto the public street network, the project will provide onsite video monitoring and designate staff to direct traffic during busy periods, as needed. If an order were taking too long for a vehicle at the pickup window, and staff sees on the monitoring cameras that the queue length is extending out of the designated drive-through lane, staff could send the vehicle at the window to overflow/curb side parking stalls to keep the queue moving forward, and then, bring the order out to the waiting vehicle when ready.

# **Appendix A Traffic Counts**

---





(303) 216-2439  
www.alltrafficdata.net

Location: 1 MISSION BLVD & INDUSTRIAL PKWY AM

Date and Start Time: Tuesday, November 17, 2015

Peak Hour: 07:15 AM - 08:15 AM

Peak 15-Minutes: 07:30 AM - 07:45 AM

**Peak Hour - All Vehicles**

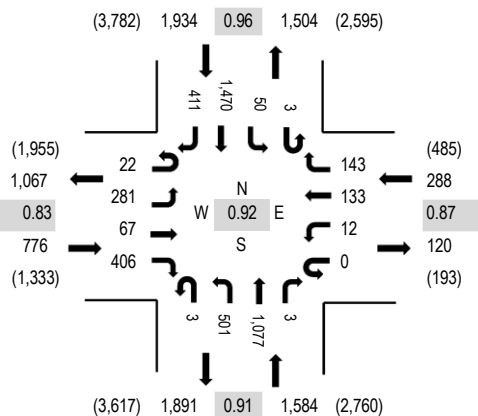

**Peak Hour - Pedestrians/Bicycles in Crosswalk**

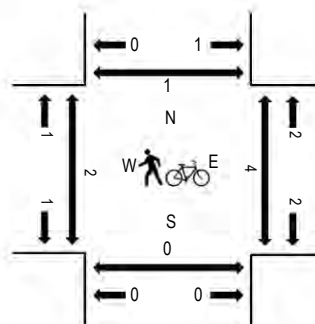

Note: Total study counts contained in parentheses.

**Traffic Counts**

Interval Start Time	INDUSTRIAL PKWY Eastbound				INDUSTRIAL PKWY Westbound				MISSION BLVD Northbound				MISSION BLVD Southbound				Total	Rolling Hour	Pedestrian Crossings			
	U-Turn	Left	Thru	Right	U-Turn	Left	Thru	Right	U-Turn	Left	Thru	Right	U-Turn	Left	Thru	Right			West	East	South	North
7:00:00 AM	2	47	8	72	0	7	36	26	3	93	196	1	0	7	432	93	1,023	4,488	2	0	0	0
7:15:00 AM	7	50	4	101	0	4	22	26	0	118	224	1	0	8	374	96	1,035	4,582	0	1	0	0
7:30:00 AM	8	103	18	96	0	4	36	41	1	120	315	1	3	9	370	121	1,246	4,575	0	2	0	0
7:45:00 AM	4	84	23	122	0	0	35	48	2	124	275	1	0	20	351	95	1,184	4,221	1	1	0	0
8:00:00 AM	3	44	22	87	0	4	40	28	0	139	263	0	0	13	375	99	1,117	3,872	1	0	0	1
8:15:00 AM	3	47	9	98	0	4	26	22	0	91	235	1	2	11	376	103	1,028		0	0	0	0
8:30:00 AM	3	45	8	86	0	3	25	16	1	93	175	0	0	12	307	118	892		0	0	0	0
8:45:00 AM	4	56	3	66	0	4	17	11	0	74	212	1	1	12	267	107	835		0	0	0	0

**Peak Rolling Hour Flow Rates**

Vehicle Type	Eastbound				Westbound				Northbound				Southbound				Total
	U-Turn	Left	Thru	Right	U-Turn	Left	Thru	Right	U-Turn	Left	Thru	Right	U-Turn	Left	Thru	Right	
Articulated Trucks	0	0	0	4	0	0	0	0	0	6	4	0	0	0	1	4	19
Lights	22	264	67	384	0	12	129	142	3	482	1,045	3	3	46	1,446	401	4,449
Mediums	0	17	0	18	0	0	4	1	0	13	28	0	0	4	23	6	114
<b>Total</b>	<b>22</b>	<b>281</b>	<b>67</b>	<b>406</b>	<b>0</b>	<b>12</b>	<b>133</b>	<b>143</b>	<b>3</b>	<b>501</b>	<b>1,077</b>	<b>3</b>	<b>3</b>	<b>50</b>	<b>1,470</b>	<b>411</b>	<b>4,582</b>



(303) 216-2439  
www.alltrafficdata.net

Location: 2 MISSION BLVD & GARIN AVE AM  
Date and Start Time: Tuesday, November 17, 2015  
Peak Hour: 07:00 AM - 08:00 AM  
Peak 15-Minutes: 07:30 AM - 07:45 AM

**Peak Hour - All Vehicles**

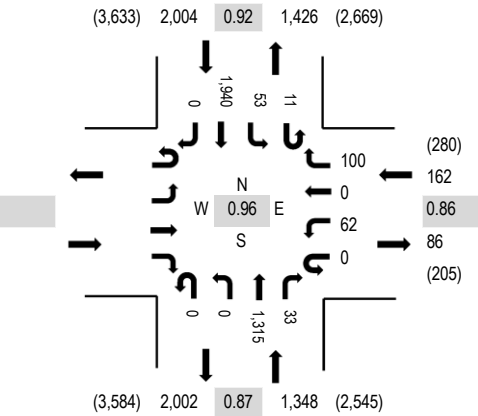

**Peak Hour - Pedestrians/Bicycles in Crosswalk**

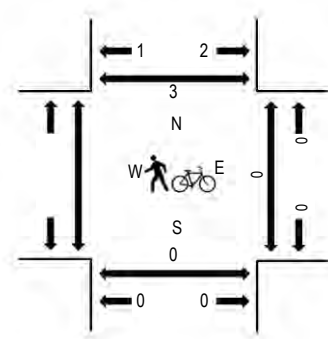

Note: Total study counts contained in parentheses.

**Traffic Counts**

Interval Start Time	GARIN AVE				MISSION BLVD				MISSION BLVD				Total	Rolling Hour	Pedestrian Crossings						
	Eastbound		Westbound		Northbound		Southbound		Northbound		Southbound				West	East	South	North			
	U-Turn	Left	Thru	Right	U-Turn	Left	Thru	Right	U-Turn	Left	Thru	Right									
7:00:00 AM					0	19	0	20	0	0	279	9	5	8	532	0	872	3,514	0	0	0
7:15:00 AM					0	16	0	23	0	0	316	10	2	14	480	0	861	3,496	0	0	1
7:30:00 AM					0	11	0	26	0	0	380	8	0	17	469	0	911	3,439	0	0	1
7:45:00 AM					0	16	0	31	0	0	340	6	4	14	459	0	870	3,167	0	0	0
8:00:00 AM					0	12	0	31	0	0	345	17	2	23	424	0	854	2,944	0	0	0
8:15:00 AM					0	13	0	9	0	0	312	5	1	29	435	0	804		0	0	2
8:30:00 AM					0	4	0	15	0	0	243	12	7	12	346	0	639		1	0	2
8:45:00 AM					0	13	0	21	0	0	255	8	2	13	335	0	647		0	0	2

**Peak Rolling Hour Flow Rates**

Vehicle Type	Eastbound				Westbound				Northbound				Southbound				Total
	U-Turn	Left	Thru	Right	U-Turn	Left	Thru	Right	U-Turn	Left	Thru	Right	U-Turn	Left	Thru	Right	
Articulated Trucks					0	0	0	0	0	0	6	0	0	0	4	0	10
Lights					0	62	0	99	0	0	1,273	32	11	53	1,891	0	3,421
Mediums					0	0	0	1	0	0	36	1	0	0	45	0	83
Total					0	62	0	100	0	0	1,315	33	11	53	1,940	0	3,514



(303) 216-2439  
www.alltrafficdata.net

Location: 3 MISSION BLVD & ARROWHEAD WAY AM

Date and Start Time: Tuesday, November 17, 2015

Peak Hour: 07:30 AM - 08:30 AM

Peak 15-Minutes: 08:00 AM - 08:15 AM

**Peak Hour - All Vehicles**

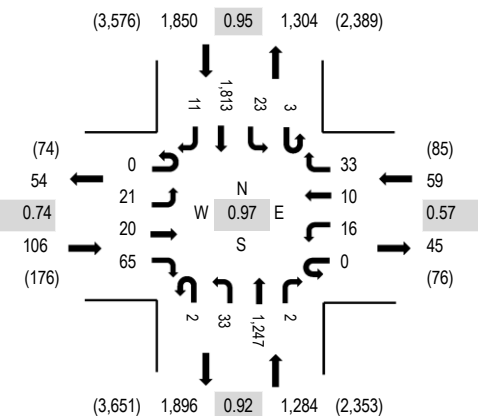

**Peak Hour - Pedestrians/Bicycles in Crosswalk**

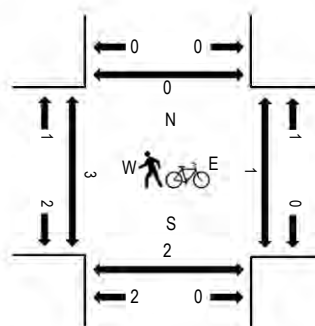

Note: Total study counts contained in parentheses.

**Traffic Counts**

Interval Start Time	ARROWHEAD WAY Eastbound				ARROWHEAD WAY Westbound				MISSION BLVD Northbound				MISSION BLVD Southbound				Total	Rolling Hour	Pedestrian Crossings			
	U-Turn	Left	Thru	Right	U-Turn	Left	Thru	Right	U-Turn	Left	Thru	Right	U-Turn	Left	Thru	Right			West	East	South	North
7:00:00 AM	0	7	0	10	0	3	0	6	0	3	263	1	0	4	545	2	844	3,230	1	0	0	0
7:15:00 AM	0	3	1	12	0	7	0	2	0	4	270	0	0	3	440	0	742	3,239	1	0	1	0
7:30:00 AM	0	6	1	10	0	1	0	3	1	5	313	1	0	4	479	3	827	3,299	0	1	0	0
7:45:00 AM	0	5	4	27	0	4	2	9	0	5	288	0	1	11	460	1	817	3,113	1	0	0	0
8:00:00 AM	0	8	13	15	0	4	6	16	0	11	337	1	1	7	430	4	853	2,960	2	0	2	0
8:15:00 AM	0	2	2	13	0	7	2	5	1	12	309	0	1	1	444	3	802		0	0	0	0
8:30:00 AM	0	6	0	12	0	1	0	2	0	4	265	4	0	6	339	2	641		2	1	1	0
8:45:00 AM	0	7	0	12	0	1	1	3	0	2	248	5	3	7	373	2	664		4	1	1	0

**Peak Rolling Hour Flow Rates**

Vehicle Type	Eastbound				Westbound				Northbound				Southbound				Total
	U-Turn	Left	Thru	Right	U-Turn	Left	Thru	Right	U-Turn	Left	Thru	Right	U-Turn	Left	Thru	Right	
Articulated Trucks	0	0	0	0	0	0	0	0	0	0	10	0	0	0	5	0	15
Lights	0	21	20	63	0	16	10	32	2	33	1,202	2	3	22	1,771	10	3,207
Mediums	0	0	0	2	0	0	0	1	0	0	35	0	0	1	37	1	77
<b>Total</b>	0	21	20	65	0	16	10	33	2	33	1,247	2	3	23	1,813	11	3,299



(303) 216-2439  
www.alltrafficdata.net

Location: 4 ARROWHEAD WAY & INDUSTRIAL PKWY AM

Date and Start Time: Tuesday, November 17, 2015

Peak Hour: 07:15 AM - 08:15 AM

Peak 15-Minutes: 07:30 AM - 07:45 AM

**Peak Hour - All Vehicles**

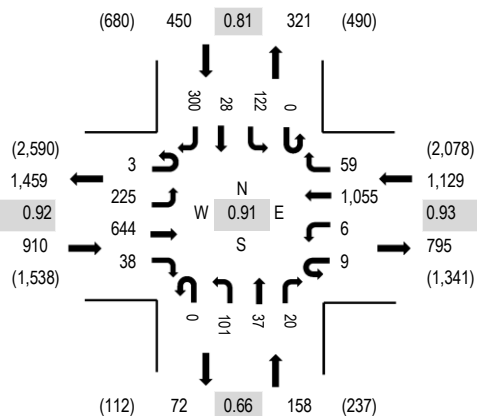

**Peak Hour - Pedestrians/Bicycles in Crosswalk**

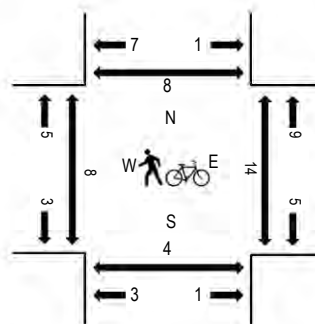

Note: Total study counts contained in parentheses.

**Traffic Counts**

Interval Start Time	INDUSTRIAL PKWY Eastbound				INDUSTRIAL PKWY Westbound				ARROWHEAD WAY Northbound				DIXON ST Southbound				Total	Rolling Hour	Pedestrian Crossings			
	U-Turn	Left	Thru	Right	U-Turn	Left	Thru	Right	U-Turn	Left	Thru	Right	U-Turn	Left	Thru	Right			West	East	South	North
7:00:00 AM	1	43	105	0	1	0	243	3	0	26	4	3	0	22	1	55	507	2,521	2	8	4	3
7:15:00 AM	0	46	150	9	1	1	243	8	0	14	9	3	0	28	3	68	583	2,647	3	6	2	1
7:30:00 AM	0	59	182	4	2	1	292	10	0	41	13	6	0	36	5	74	725	2,581	2	3	1	1
7:45:00 AM	2	68	166	12	2	2	260	18	0	24	9	4	0	36	8	95	706	2,296	1	3	1	3
8:00:00 AM	1	52	146	13	4	2	260	23	0	22	6	7	0	22	12	63	633	2,012	1	2	0	3
8:15:00 AM	1	45	139	12	1	1	227	13	0	12	1	1	0	17	4	43	517		4	2	0	0
8:30:00 AM	1	27	108	5	3	2	227	6	0	10	2	6	0	8	2	33	440		1	0	0	1
8:45:00 AM	0	15	120	6	1	2	209	10	0	11	0	3	0	8	5	32	422		1	1	4	0

**Peak Rolling Hour Flow Rates**

Vehicle Type	Eastbound				Westbound				Northbound				Southbound				Total
	U-Turn	Left	Thru	Right	U-Turn	Left	Thru	Right	U-Turn	Left	Thru	Right	U-Turn	Left	Thru	Right	
Articulated Trucks	0	0	0	0	0	0	10	0	0	0	0	0	0	0	0	1	11
Lights	3	223	614	36	9	6	1,022	57	0	99	35	20	0	119	26	296	2,565
Mediums	0	2	30	2	0	0	23	2	0	2	2	0	0	3	2	3	71
Total	3	225	644	38	9	6	1,055	59	0	101	37	20	0	122	28	300	2,647



(303) 216-2439  
www.alltrafficdata.net

Location: 1 MISSION BLVD & INDUSTRIAL PKWY PM

Date and Start Time: Tuesday, November 17, 2015

Peak Hour: 04:45 PM - 05:45 PM

Peak 15-Minutes: 04:45 PM - 05:00 PM

**Peak Hour - All Vehicles**

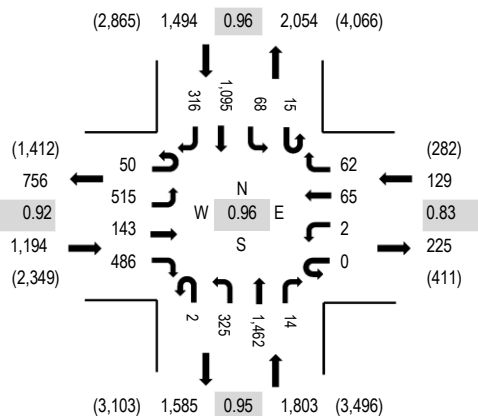

**Peak Hour - Pedestrians/Bicycles in Crosswalk**

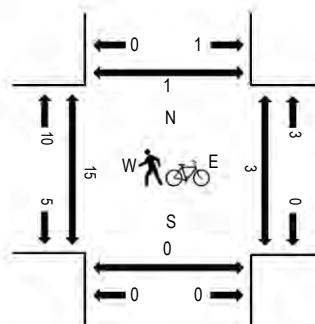

Note: Total study counts contained in parentheses.

**Traffic Counts**

Interval Start Time	INDUSTRIAL PKWY Eastbound				INDUSTRIAL PKWY Westbound				MISSION BLVD Northbound				MISSION BLVD Southbound				Total	Rolling Hour	Pedestrian Crossings			
	U-Turn	Left	Thru	Right	U-Turn	Left	Thru	Right	U-Turn	Left	Thru	Right	U-Turn	Left	Thru	Right			West	East	South	North
4:00:00 PM	1	160	24	115	0	2	19	15	0	87	363	4	1	12	243	67	1,113	4,477	1	2	0	0
4:15:00 PM	9	125	18	118	0	2	12	23	1	79	342	4	5	21	278	61	1,098	4,482	1	0	1	0
4:30:00 PM	7	140	35	133	0	2	14	22	1	88	310	4	4	11	238	57	1,066	4,556	1	1	0	0
4:45:00 PM	16	138	38	134	0	1	12	12	1	99	371	4	4	13	265	92	1,200	4,620	2	0	0	0
5:00:00 PM	14	118	25	133	0	0	15	15	0	66	343	1	5	15	300	68	1,118	4,515	3	0	0	0
5:15:00 PM	10	139	47	95	0	0	20	19	0	83	379	3	5	22	267	83	1,172		2	3	0	1
5:30:00 PM	10	120	33	124	0	1	18	16	1	77	369	6	1	18	263	73	1,130		3	0	0	0
5:45:00 PM	20	113	36	101	0	0	19	23	1	48	360	1	6	16	283	68	1,095		1	0	0	0

**Peak Rolling Hour Flow Rates**

Vehicle Type	Eastbound				Westbound				Northbound				Southbound				Total
	U-Turn	Left	Thru	Right	U-Turn	Left	Thru	Right	U-Turn	Left	Thru	Right	U-Turn	Left	Thru	Right	
Articulated Trucks	0	1	0	2	0	0	0	0	0	2	1	0	0	0	0	3	9
Lights	50	512	142	477	0	2	64	62	2	316	1,446	13	15	68	1,078	300	4,547
Mediums	0	2	1	7	0	0	1	0	0	7	15	1	0	0	17	13	64
<b>Total</b>	<b>50</b>	<b>515</b>	<b>143</b>	<b>486</b>	<b>0</b>	<b>2</b>	<b>65</b>	<b>62</b>	<b>2</b>	<b>325</b>	<b>1,462</b>	<b>14</b>	<b>15</b>	<b>68</b>	<b>1,095</b>	<b>316</b>	<b>4,620</b>



(303) 216-2439  
www.alltrafficdata.net

Location: 2 MISSION BLVD & GARIN AVE PM  
Date and Start Time: Tuesday, November 17, 2015  
Peak Hour: 05:00 PM - 06:00 PM  
Peak 15-Minutes: 05:15 PM - 05:30 PM

**Peak Hour - All Vehicles**

(3,119) 1,625 0.97 1,799 (3,489)

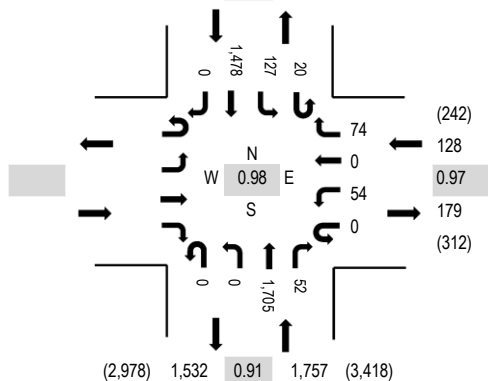

**Peak Hour - Pedestrians/Bicycles in Crosswalk**

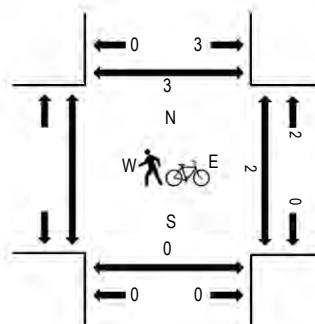

Note: Total study counts contained in parentheses.

**Traffic Counts**

Interval Start Time	GARIN AVE				MISSION BLVD				MISSION BLVD				Total	Rolling Hour	Pedestrian Crossings						
	Eastbound		Westbound		Northbound		Southbound		U-Turn	Left	Thru	Right			West	East	South	North			
4:00:00 PM					0	7	0	18	0	0	422	11	1	17	339	0	815	3,269	1	0	0
4:15:00 PM					0	10	0	18	0	0	374	14	2	13	366	0	797	3,302	2	0	1
4:30:00 PM					0	11	0	18	1	0	381	17	4	23	338	0	793	3,402	1	0	0
4:45:00 PM					0	10	0	22	0	0	428	13	2	25	364	0	864	3,490	0	0	0
5:00:00 PM					0	12	0	20	0	0	389	9	5	19	394	0	848	3,510	0	0	2
5:15:00 PM					0	8	0	22	0	0	473	11	6	25	352	0	897		0	0	1
5:30:00 PM					0	17	0	16	0	0	415	14	6	41	372	0	881		0	0	0
5:45:00 PM					0	17	0	16	0	0	428	18	3	42	360	0	884		2	0	0

**Peak Rolling Hour Flow Rates**

Vehicle Type	Eastbound				Westbound				Northbound				Southbound				Total
	U-Turn	Left	Thru	Right	U-Turn	Left	Thru	Right	U-Turn	Left	Thru	Right	U-Turn	Left	Thru	Right	
Articulated Trucks					0	0	0	0	0	0	5	0	0	0	3	0	8
Lights					0	53	0	72	0	0	1,680	52	20	125	1,455	0	3,457
Mediums					0	1	0	2	0	0	20	0	0	2	20	0	45
Total					0	54	0	74	0	0	1,705	52	20	127	1,478	0	3,510





(303) 216-2439  
www.alltrafficdata.net

Location: 3 MISSION BLVD & ARROWHEAD WAY PM

Date and Start Time: Tuesday, November 17, 2015

Peak Hour: 05:00 PM - 06:00 PM

Peak 15-Minutes: 05:45 PM - 06:00 PM

**Peak Hour - All Vehicles**

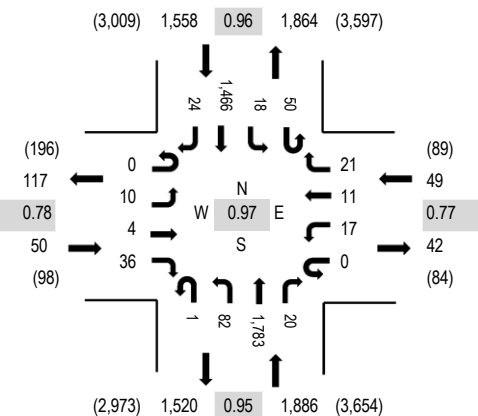

**Peak Hour - Pedestrians/Bicycles in Crosswalk**

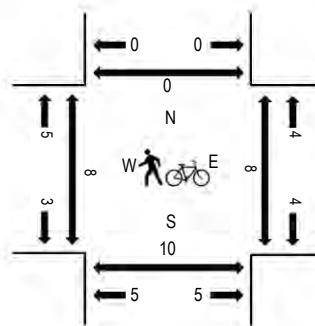

Note: Total study counts contained in parentheses.

**Traffic Counts**

Interval Start Time	ARROWHEAD WAY Eastbound				ARROWHEAD WAY Westbound				MISSION BLVD Northbound				MISSION BLVD Southbound				Total	Rolling Hour	Pedestrian Crossings			
	U-Turn	Left	Thru	Right	U-Turn	Left	Thru	Right	U-Turn	Left	Thru	Right	U-Turn	Left	Thru	Right			West	East	South	North
4:00:00 PM	0	0	1	10	0	4	2	4	0	16	454	6	7	5	328	4	841	3,307	1	1	1	0
4:15:00 PM	0	4	0	5	0	6	0	1	0	9	377	9	4	5	352	2	774	3,354	1	0	0	0
4:30:00 PM	0	1	2	14	0	4	2	6	0	22	416	2	5	5	338	2	819	3,477	0	1	1	0
4:45:00 PM	0	2	1	8	0	1	2	8	0	13	441	3	3	3	383	5	873	3,502	4	1	1	0
5:00:00 PM	0	1	0	9	0	5	3	5	0	21	430	9	6	2	391	6	888	3,543	2	1	1	0
5:15:00 PM	0	6	4	6	0	3	3	7	0	20	463	5	15	1	359	5	897		0	1	3	0
5:30:00 PM	0	2	0	6	0	1	3	3	1	14	425	1	8	5	365	10	844		0	5	3	0
5:45:00 PM	0	1	0	15	0	8	2	6	0	27	465	5	21	10	351	3	914		0	1	0	0

**Peak Rolling Hour Flow Rates**

Vehicle Type	Eastbound				Westbound				Northbound				Southbound				Total
	U-Turn	Left	Thru	Right	U-Turn	Left	Thru	Right	U-Turn	Left	Thru	Right	U-Turn	Left	Thru	Right	
Articulated Trucks	0	0	0	0	0	0	0	0	0	0	7	0	0	0	2	0	9
Lights	0	10	4	36	0	17	11	21	1	81	1,753	20	49	17	1,439	24	3,483
Mediums	0	0	0	0	0	0	0	0	0	1	23	0	1	1	25	0	51
Total	0	10	4	36	0	17	11	21	1	82	1,783	20	50	18	1,466	24	3,543



(303) 216-2439  
www.alltrafficdata.net

Location: 4 ARROWHEAD WAY & INDUSTRIAL PKWY PM

Date and Start Time: Tuesday, November 17, 2015

Peak Hour: 04:45 PM - 05:45 PM

Peak 15-Minutes: 05:30 PM - 05:45 PM

**Peak Hour - All Vehicles**

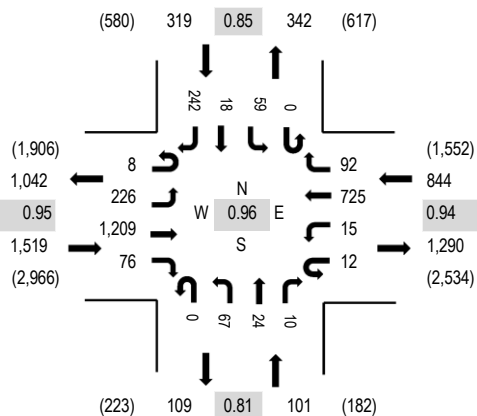

**Peak Hour - Pedestrians/Bicycles in Crosswalk**

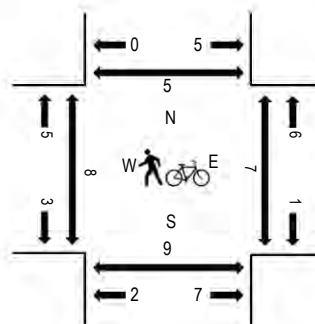

Note: Total study counts contained in parentheses.

**Traffic Counts**

Interval Start Time	INDUSTRIAL PKWY Eastbound				INDUSTRIAL PKWY Westbound				ARROWHEAD WAY Northbound				DIXON ST Southbound				Total	Rolling Hour	Pedestrian Crossings			
	U-Turn	Left	Thru	Right	U-Turn	Left	Thru	Right	U-Turn	Left	Thru	Right	U-Turn	Left	Thru	Right			West	East	South	North
4:00:00 PM	4	44	318	24	3	3	152	20	0	14	2	2	1	9	6	33	635	2,521	1	3	2	0
4:15:00 PM	3	39	251	17	5	2	128	17	0	8	3	2	0	11	2	43	531	2,573	1	3	1	1
4:30:00 PM	1	48	314	23	3	3	156	26	0	23	1	1	0	17	3	47	666	2,725	0	0	0	1
4:45:00 PM	3	65	315	15	3	5	174	25	0	10	5	2	0	16	3	48	689	2,783	0	3	1	0
5:00:00 PM	4	58	290	24	3	2	164	23	0	24	7	0	0	18	8	62	687	2,759	0	1	1	0
5:15:00 PM	1	51	302	12	3	6	184	28	0	16	5	5	0	8	6	56	683		6	2	6	1
5:30:00 PM	0	52	302	25	3	2	203	16	0	17	7	3	0	17	1	76	724		0	0	0	4
5:45:00 PM	0	48	289	24	2	5	161	22	0	18	4	3	0	14	2	73	665		1	2	1	2

**Peak Rolling Hour Flow Rates**

Vehicle Type	Eastbound				Westbound				Northbound				Southbound				Total
	U-Turn	Left	Thru	Right	U-Turn	Left	Thru	Right	U-Turn	Left	Thru	Right	U-Turn	Left	Thru	Right	
Articulated Trucks	1	0	5	0	0	0	0	0	0	0	0	0	0	0	0	0	6
Lights	7	225	1,194	76	12	14	700	91	0	67	24	10	0	58	18	241	2,737
Mediums	0	1	10	0	0	1	25	1	0	0	0	0	0	1	0	1	40
Total	8	226	1,209	76	12	15	725	92	0	67	24	10	0	59	18	242	2,783





















# **Appendix B**

## **Level of Service Calculations**



Existing AM Peak Hour  
1: Arrowhead Way/Dixon St & Industrial Pkwy































01/21/2021

												
Movement	EBL	EBT	EBR	WBL	WBT	WBR	NBL	NBT	NBR	SBL	SBT	SBR
Lane Configurations												
Traffic Volume (vph)	240	677	40	16	1109	62	106	39	21	128	29	315
Future Volume (vph)	240	677	40	16	1109	62	106	39	21	128	29	315
Ideal Flow (vphpl)	1900	1900	1900	1900	1900	1900	1900	1900	1900	1900	1900	1900
Total Lost time (s)	4.0	5.0		4.0	5.0		5.0	5.0			5.0	5.0
Lane Util. Factor	1.00	0.95		1.00	0.95		1.00	1.00			1.00	1.00
Frbp, ped/bikes	1.00	1.00		1.00	1.00		1.00	0.99			1.00	0.98
Flpb, ped/bikes	1.00	1.00		1.00	1.00		1.00	1.00			0.99	1.00
Frt	1.00	0.99		1.00	0.99		1.00	0.95			1.00	0.85
Flt Protected	0.95	1.00		0.95	1.00		0.95	1.00			0.96	1.00
Satd. Flow (prot)	1770	3505		1766	3505		1762	1750			1777	1555
Flt Permitted	0.95	1.00		0.95	1.00		0.63	1.00			0.72	1.00
Satd. Flow (perm)	1770	3505		1766	3505		1177	1750			1335	1555
Peak-hour factor, PHF	0.92	0.92	0.92	0.92	0.92	0.92	0.92	0.92	0.92	0.92	0.92	0.92
Adj. Flow (vph)	261	736	43	17	1205	67	115	42	23	139	32	342
RTOR Reduction (vph)	0	4	0	0	5	0	0	18	0	0	0	180
Lane Group Flow (vph)	261	775	0	17	1267	0	115	47	0	0	171	162
Confl. Peds. (#/hr)	8		4	4		8	8		14	14		8
Turn Type	Prot	NA		Prot	NA		Perm	NA		Perm	NA	Perm
Protected Phases	7	4		3	8			2			6	
Permitted Phases							2			6		6
Actuated Green, G (s)	10.1	35.7		0.9	26.5		13.9	13.9			13.9	13.9
Effective Green, g (s)	10.1	35.7		0.9	26.5		13.9	13.9			13.9	13.9
Actuated g/C Ratio	0.16	0.55		0.01	0.41		0.22	0.22			0.22	0.22
Clearance Time (s)	4.0	5.0		4.0	5.0		5.0	5.0			5.0	5.0
Vehicle Extension (s)	3.0	3.0		3.0	3.0		3.0	3.0			3.0	3.0
Lane Grp Cap (vph)	277	1939		24	1440		253	377			287	335
v/s Ratio Prot	c0.15	0.22		0.01	c0.36			0.03				
v/s Ratio Perm							0.10				c0.13	0.10
v/c Ratio	0.94	0.40		0.71	0.88		0.45	0.12			0.60	0.48
Uniform Delay, d1	26.9	8.3		31.7	17.5		22.0	20.4			22.8	22.2
Progression Factor	1.00	1.00		1.00	1.00		1.00	1.00			1.00	1.00
Incremental Delay, d2	38.6	0.1		65.6	6.6		1.3	0.1			3.3	1.1
Delay (s)	65.5	8.4		97.3	24.1		23.3	20.5			26.1	23.3
Level of Service	E	A		F	C		C	C			C	C
Approach Delay (s)		22.7			25.1			22.3			24.2	
Approach LOS		C			C			C			C	
<b>Intersection Summary</b>												
HCM 2000 Control Delay			24.0			HCM 2000 Level of Service					C	
HCM 2000 Volume to Capacity ratio			0.81									
Actuated Cycle Length (s)			64.5			Sum of lost time (s)			14.0			
Intersection Capacity Utilization			78.1%			ICU Level of Service					D	
Analysis Period (min)			15									
c	Critical Lane Group											

## Existing AM Peak Hour

## 2: Mission Blvd &amp; Industrial Pkwy/Alquire Pkwy

01/21/2021

													
Movement	EBL	EBT	EBR	WBL	WBT	WBR	NBL	NBT	NBR	SBL	SBT	SBR	
Lane Configurations	 	 			 		 	  			  		
Traffic Volume (vph)	318	70	427	13	140	150	530	1132	3	56	1545	432	
Future Volume (vph)	318	70	427	13	140	150	530	1132	3	56	1545	432	
Ideal Flow (vphpl)	1900	1900	1900	1900	1900	1900	1900	1900	1900	1900	1900	1900	
Total Lost time (s)	4.0	4.0	4.0	4.0	4.0	4.0	4.0	4.0		4.0	4.0		
Lane Util. Factor	0.97	0.91	0.91	1.00	0.95	1.00	0.97	0.91		1.00	0.91		
Frpb, ped/bikes	1.00	1.00	1.00	1.00	1.00	0.99	1.00	1.00		1.00	1.00		
Flpb, ped/bikes	1.00	1.00	1.00	1.00	1.00	1.00	1.00	1.00		1.00	1.00		
Frt	1.00	0.89	0.85	1.00	1.00	0.85	1.00	1.00		1.00	0.97		
Flt Protected	0.95	1.00	1.00	0.95	1.00	1.00	0.95	1.00		0.95	1.00		
Satd. Flow (prot)	3433	3007	1441	1770	3539	1563	3433	5083		1770	4904		
Flt Permitted	0.95	1.00	1.00	0.95	1.00	1.00	0.95	1.00		0.95	1.00		
Satd. Flow (perm)	3433	3007	1441	1770	3539	1563	3433	5083		1770	4904		
Peak-hour factor, PHF	0.92	0.92	0.92	0.92	0.92	0.92	0.92	0.92	0.92	0.92	0.92	0.92	
Adj. Flow (vph)	346	76	464	14	152	163	576	1230	3	61	1679	470	
RTOR Reduction (vph)	0	181	181	0	0	141	0	0	0	0	34	0	
Lane Group Flow (vph)	346	127	51	14	152	22	576	1233	0	61	2115	0	
Confl. Peds. (#/hr)	1					1	2		4	4		2	
Turn Type	Prot	NA	Perm	Prot	NA	Perm	Prot	NA		Prot	NA		
Protected Phases	7	4		3	8		5	2		1	6		
Permitted Phases			4			8							
Actuated Green, G (s)	11.0	23.3	23.3	0.8	13.1	13.1	18.0	60.0		6.9	48.9		
Effective Green, g (s)	11.0	23.3	23.3	0.8	13.1	13.1	18.0	60.0		6.9	48.9		
Actuated g/C Ratio	0.10	0.22	0.22	0.01	0.12	0.12	0.17	0.56		0.06	0.46		
Clearance Time (s)	4.0	4.0	4.0	4.0	4.0	4.0	4.0	4.0		4.0	4.0		
Vehicle Extension (s)	3.0	3.0	3.0	3.0	3.0	3.0	3.0	3.0		3.0	3.0		
Lane Grp Cap (vph)	352	654	313	13	433	191	577	2850		114	2241		
v/s Ratio Prot	c0.10	0.04		0.01	c0.04		c0.17	0.24		0.03	c0.43		
v/s Ratio Perm			0.04			0.01							
v/c Ratio	0.98	0.19	0.16	1.08	0.35	0.11	1.00	0.43		0.54	0.94		
Uniform Delay, d1	47.9	34.2	33.9	53.1	43.1	41.8	44.5	13.6		48.5	27.7		
Progression Factor	1.00	1.00	1.00	1.00	1.00	1.00	1.00	1.00		1.00	1.00		
Incremental Delay, d2	43.1	0.1	0.2	276.9	0.5	0.3	36.7	0.5		4.8	9.8		
Delay (s)	91.0	34.3	34.2	330.0	43.5	42.0	81.2	14.1		53.3	37.5		
Level of Service	F	C	C	F	D	D	F	B		D	D		
Approach Delay (s)		56.4			55.0			35.5			37.9		
Approach LOS		E			D			D			D		
<b>Intersection Summary</b>													
HCM 2000 Control Delay			41.3									HCM 2000 Level of Service	D
HCM 2000 Volume to Capacity ratio			0.87										
Actuated Cycle Length (s)			107.0									Sum of lost time (s)	16.0
Intersection Capacity Utilization			81.8%									ICU Level of Service	D
Analysis Period (min)			15										
Description: 29827 Mission Blvd													
c Critical Lane Group													

Existing AM Peak Hour  
3: Mission Blvd & Garin Ave

01/21/2021

























Movement	WBL	WBR	NBT	NBR	SBL	SBT
Lane Configurations						
Traffic Volume (vph)	65	105	1382	35	67	2039
Future Volume (vph)	65	105	1382	35	67	2039
Ideal Flow (vphpl)	1900	1900	1900	1900	1900	1900
Total Lost time (s)	4.0	4.0	4.0	4.0	4.0	4.0
Lane Util. Factor	1.00	1.00	0.95	1.00	1.00	0.91
Frpb, ped/bikes	1.00	0.99	1.00	1.00	1.00	1.00
Flpb, ped/bikes	1.00	1.00	1.00	1.00	1.00	1.00
Frt	1.00	0.85	1.00	0.85	1.00	1.00
Flt Protected	0.95	1.00	1.00	1.00	0.95	1.00
Satd. Flow (prot)	1770	1562	3539	1583	1770	5085
Flt Permitted	0.95	1.00	1.00	1.00	0.95	1.00
Satd. Flow (perm)	1770	1562	3539	1583	1770	5085
Peak-hour factor, PHF	0.92	0.92	0.92	0.92	0.92	0.92
Adj. Flow (vph)	71	114	1502	38	73	2216
RTOR Reduction (vph)	0	99	0	8	0	0
Lane Group Flow (vph)	71	15	1502	30	73	2216
Confl. Peds. (#/hr)		3				
Turn Type	Prot	Perm	NA	Perm	Prot	NA
Protected Phases	8		2		1	6
Permitted Phases		8		2		
Actuated Green, G (s)	6.8	6.8	40.9	40.9	4.0	48.9
Effective Green, g (s)	6.8	6.8	40.9	40.9	4.0	48.9
Actuated g/C Ratio	0.11	0.11	0.64	0.64	0.06	0.77
Clearance Time (s)	4.0	4.0	4.0	4.0	4.0	4.0
Vehicle Extension (s)	3.0	3.0	3.0	3.0	3.0	3.0
Lane Grp Cap (vph)	188	166	2272	1016	111	3903
v/s Ratio Prot	c0.04		c0.42		0.04	c0.44
v/s Ratio Perm		0.01		0.02		
v/c Ratio	0.38	0.09	0.66	0.03	0.66	0.57
Uniform Delay, d1	26.5	25.7	7.1	4.2	29.2	3.0
Progression Factor	1.00	1.00	1.00	1.00	1.00	1.00
Incremental Delay, d2	1.3	0.2	1.5	0.1	13.2	0.6
Delay (s)	27.8	25.9	8.6	4.2	42.4	3.7
Level of Service	C	C	A	A	D	A
Approach Delay (s)	26.6		8.5			4.9
Approach LOS	C		A			A

Intersection Summary			
HCM 2000 Control Delay	7.3	HCM 2000 Level of Service	A
HCM 2000 Volume to Capacity ratio	0.63		
Actuated Cycle Length (s)	63.7	Sum of lost time (s)	12.0
Intersection Capacity Utilization	58.0%	ICU Level of Service	B
Analysis Period (min)	15		
c Critical Lane Group			























Existing AM Peak Hour  
4: Mission Blvd & Arrowhead Way

01/21/2021

													
Movement	EBL	EBT	EBR	WBL	WBT	WBR	NBL	NBT	NBR	SBL	SBT	SBR	
Lane Configurations													
Traffic Volume (vph)	22	21	68	17	11	35	37	1311	2	27	1905	12	
Future Volume (vph)	22	21	68	17	11	35	37	1311	2	27	1905	12	
Ideal Flow (vphpl)	1900	1900	1900	1900	1900	1900	1900	1900	1900	1900	1900	1900	
Total Lost time (s)	4.0	4.0		4.0	4.0		4.0	4.0		4.0	4.0		
Lane Util. Factor	1.00	1.00		1.00	1.00		1.00	0.95		1.00	0.95		
Frbp, ped/bikes	1.00	0.99		1.00	1.00		1.00	1.00		1.00	1.00		
Flpb, ped/bikes	1.00	1.00		1.00	1.00		1.00	1.00		1.00	1.00		
Frt	1.00	0.89		1.00	0.89		1.00	1.00		1.00	1.00		
Flt Protected	0.95	1.00		0.95	1.00		0.95	1.00		0.95	1.00		
Satd. Flow (prot)	1770	1633		1767	1650		1770	3538		1770	3535		
Flt Permitted	0.72	1.00		0.69	1.00		0.95	1.00		0.95	1.00		
Satd. Flow (perm)	1349	1633		1292	1650		1770	3538		1770	3535		
Peak-hour factor, PHF	0.92	0.92	0.92	0.92	0.92	0.92	0.92	0.92	0.92	0.92	0.92	0.92	
Adj. Flow (vph)	24	23	74	18	12	38	40	1425	2	29	2071	13	
RTOR Reduction (vph)	0	68	0	0	35	0	0	0	0	0	0	0	
Lane Group Flow (vph)	24	29	0	18	15	0	40	1427	0	29	2084	0	
Confl. Peds. (#/hr)			2	2			3		1	1		3	
Turn Type	Perm	NA		Perm	NA		Prot	NA		Prot	NA		
Protected Phases		4			8		5	2		1	6		
Permitted Phases	4			8									
Actuated Green, G (s)	5.9	5.9		5.9	5.9		2.4	50.6		1.6	49.8		
Effective Green, g (s)	5.9	5.9		5.9	5.9		2.4	50.6		1.6	49.8		
Actuated g/C Ratio	0.08	0.08		0.08	0.08		0.03	0.72		0.02	0.71		
Clearance Time (s)	4.0	4.0		4.0	4.0		4.0	4.0		4.0	4.0		
Vehicle Extension (s)	3.0	3.0		3.0	3.0		3.0	3.0		3.0	3.0		
Lane Grp Cap (vph)	113	137		108	138		60	2553		40	2511		
v/s Ratio Prot		c0.02			0.01		c0.02	0.40		0.02	c0.59		
v/s Ratio Perm	0.02			0.01									
v/c Ratio	0.21	0.21		0.17	0.11		0.67	0.56		0.72	0.83		
Uniform Delay, d1	29.9	29.9		29.8	29.7		33.5	4.5		34.0	7.2		
Progression Factor	1.00	1.00		1.00	1.00		1.00	1.00		1.00	1.00		
Incremental Delay, d2	0.9	0.8		0.7	0.4		24.5	0.9		48.4	3.3		
Delay (s)	30.9	30.7		30.5	30.0		58.0	5.4		82.5	10.5		
Level of Service	C	C		C	C		E	A		F	B		
Approach Delay (s)		30.7			30.2			6.9			11.5		
Approach LOS		C			C			A			B		
<b>Intersection Summary</b>													
HCM 2000 Control Delay			10.7										B
HCM 2000 Volume to Capacity ratio			0.76										
Actuated Cycle Length (s)			70.1								12.0		
Intersection Capacity Utilization			68.7%										C
Analysis Period (min)			15										
c Critical Lane Group													

Existing PM Peak Hour  
1: Arrowhead Way/Dixon St & Industrial Pkwy































01/21/2021

													
Movement	EBL	EBT	EBR	WBL	WBT	WBR	NBL	NBT	NBR	SBL	SBT	SBR	
Lane Configurations													
Traffic Volume (vph)	246	1271	80	28	762	97	70	25	11	62	19	254	
Future Volume (vph)	246	1271	80	28	762	97	70	25	11	62	19	254	
Ideal Flow (vphpl)	1900	1900	1900	1900	1900	1900	1900	1900	1900	1900	1900	1900	
Total Lost time (s)	4.0	5.0		4.0	5.0		5.0	5.0			5.0	5.0	
Lane Util. Factor	1.00	0.95		1.00	0.95		1.00	1.00			1.00	1.00	
Frbp, ped/bikes	1.00	1.00		1.00	1.00		1.00	0.99			1.00	0.98	
Flpb, ped/bikes	1.00	1.00		1.00	1.00		1.00	1.00			1.00	1.00	
Frt	1.00	0.99		1.00	0.98		1.00	0.95			1.00	0.85	
Flt Protected	0.95	1.00		0.95	1.00		0.95	1.00			0.96	1.00	
Satd. Flow (prot)	1770	3501		1770	3469		1762	1768			1789	1557	
Flt Permitted	0.95	1.00		0.95	1.00		0.70	1.00			0.75	1.00	
Satd. Flow (perm)	1770	3501		1770	3469		1298	1768			1396	1557	
Peak-hour factor, PHF	0.92	0.92	0.92	0.92	0.92	0.92	0.92	0.92	0.92	0.92	0.92	0.92	
Adj. Flow (vph)	267	1382	87	30	828	105	76	27	12	67	21	276	
RTOR Reduction (vph)	0	4	0	0	11	0	0	10	0	0	0	206	
Lane Group Flow (vph)	267	1465	0	30	922	0	76	29	0	0	88	70	
Confl. Peds. (#/hr)	5		9	9		5	8		7	7		8	
Turn Type	Prot	NA		Prot	NA		Perm	NA		Perm	NA	Perm	
Protected Phases	7	4		3	8			2			6		
Permitted Phases							2			6		6	
Actuated Green, G (s)	10.1	31.1		1.8	22.8		9.3	9.3			9.3	9.3	
Effective Green, g (s)	10.1	31.1		1.8	22.8		9.3	9.3			9.3	9.3	
Actuated g/C Ratio	0.18	0.55		0.03	0.41		0.17	0.17			0.17	0.17	
Clearance Time (s)	4.0	5.0		4.0	5.0		5.0	5.0			5.0	5.0	
Vehicle Extension (s)	3.0	3.0		3.0	3.0		3.0	3.0			3.0	3.0	
Lane Grp Cap (vph)	318	1937		56	1407		214	292			231	257	
v/s Ratio Prot	c0.15	c0.42		0.02	0.27			0.02					
v/s Ratio Perm							0.06				c0.06	0.04	
v/c Ratio	0.84	0.76		0.54	0.66		0.36	0.10			0.38	0.27	
Uniform Delay, d1	22.3	9.6		26.8	13.5		20.8	19.9			20.9	20.5	
Progression Factor	1.00	1.00		1.00	1.00		1.00	1.00			1.00	1.00	
Incremental Delay, d2	17.4	1.7		9.5	1.1		1.0	0.1			1.1	0.6	
Delay (s)	39.7	11.4		36.3	14.6		21.8	20.0			21.9	21.1	
Level of Service	D	B		D	B		C	C			C	C	
Approach Delay (s)		15.7			15.3			21.2			21.3		
Approach LOS		B			B			C			C		
<b>Intersection Summary</b>													
HCM 2000 Control Delay			16.4									HCM 2000 Level of Service	B
HCM 2000 Volume to Capacity ratio			0.74										
Actuated Cycle Length (s)			56.2									Sum of lost time (s)	14.0
Intersection Capacity Utilization			67.3%									ICU Level of Service	C
Analysis Period (min)			15										
c Critical Lane Group													

## Existing PM Peak Hour

## 2: Mission Blvd &amp; Industrial Pkwy/Alquire Pkwy

01/21/2021

													
Movement	EBL	EBT	EBR	WBL	WBT	WBR	NBL	NBT	NBR	SBL	SBT	SBR	
Lane Configurations	 	 			 		 	  			  		
Traffic Volume (vph)	594	150	511	2	68	65	344	1537	15	87	1151	332	
Future Volume (vph)	594	150	511	2	68	65	344	1537	15	87	1151	332	
Ideal Flow (vphpl)	1900	1900	1900	1900	1900	1900	1900	1900	1900	1900	1900	1900	
Total Lost time (s)	4.0	4.0	4.0	4.0	4.0	4.0	4.0	4.0		4.0	4.0		
Lane Util. Factor	0.97	0.91	0.91	1.00	0.95	1.00	0.97	0.91		1.00	0.91		
Frbp, ped/bikes	1.00	1.00	1.00	1.00	1.00	0.99	1.00	1.00		1.00	0.99		
Flpb, ped/bikes	1.00	1.00	1.00	1.00	1.00	1.00	1.00	1.00		1.00	1.00		
Frt	1.00	0.91	0.85	1.00	1.00	0.85	1.00	1.00		1.00	0.97		
Flt Protected	0.95	1.00	1.00	0.95	1.00	1.00	0.95	1.00		0.95	1.00		
Satd. Flow (prot)	3433	3070	1441	1770	3539	1563	3433	5077		1770	4887		
Flt Permitted	0.95	1.00	1.00	0.95	1.00	1.00	0.95	1.00		0.95	1.00		
Satd. Flow (perm)	3433	3070	1441	1770	3539	1563	3433	5077		1770	4887		
Peak-hour factor, PHF	0.92	0.92	0.92	0.92	0.92	0.92	0.92	0.92	0.92	0.92	0.92	0.92	
Adj. Flow (vph)	646	163	555	2	74	71	374	1671	16	95	1251	361	
RTOR Reduction (vph)	0	187	186	0	0	64	0	1	0	0	36	0	
Lane Group Flow (vph)	646	254	91	2	74	7	374	1686	0	95	1576	0	
Confl. Peds. (#/hr)	1						1	15		3	3	15	
Turn Type	Prot	NA	Perm	Prot	NA	Perm	Prot	NA		Prot	NA		
Protected Phases	7	4		3	8		5	2		1	6		
Permitted Phases			4			8							
Actuated Green, G (s)	24.0	33.9	33.9	0.8	10.7	10.7	14.0	44.2		8.8	39.0		
Effective Green, g (s)	24.0	33.9	33.9	0.8	10.7	10.7	14.0	44.2		8.8	39.0		
Actuated g/C Ratio	0.23	0.33	0.33	0.01	0.10	0.10	0.14	0.43		0.08	0.38		
Clearance Time (s)	4.0	4.0	4.0	4.0	4.0	4.0	4.0	4.0		4.0	4.0		
Vehicle Extension (s)	3.0	3.0	3.0	3.0	3.0	3.0	3.0	3.0		3.0	3.0		
Lane Grp Cap (vph)	794	1003	471	13	365	161	463	2163		150	1837		
v/s Ratio Prot	c0.19	c0.08		0.00	0.02		c0.11	0.33		0.05	c0.32		
v/s Ratio Perm			0.06			0.00							
v/c Ratio	0.81	0.25	0.19	0.15	0.20	0.05	0.81	0.78		0.63	0.86		
Uniform Delay, d1	37.7	25.6	25.1	51.1	42.6	41.9	43.5	25.6		45.9	29.8		
Progression Factor	1.00	1.00	1.00	1.00	1.00	1.00	1.00	1.00		1.00	1.00		
Incremental Delay, d2	6.4	0.1	0.2	5.5	0.3	0.1	10.0	2.9		8.4	5.5		
Delay (s)	44.1	25.7	25.3	56.6	42.9	42.0	53.5	28.4		54.3	35.3		
Level of Service	D	C	C	E	D	D	D	C		D	D		
Approach Delay (s)		34.4			42.6			33.0			36.3		
Approach LOS		C			D			C			D		
<b>Intersection Summary</b>													
HCM 2000 Control Delay			34.7									HCM 2000 Level of Service	C
HCM 2000 Volume to Capacity ratio			0.77										
Actuated Cycle Length (s)			103.7									Sum of lost time (s)	16.0
Intersection Capacity Utilization			73.4%									ICU Level of Service	D
Analysis Period (min)			15										
c Critical Lane Group													

Existing PM Peak Hour  
3: Mission Blvd & Garin Ave

01/21/2021

























Movement	WBL	WBR	NBT	NBR	SBL	SBT
Lane Configurations						
Traffic Volume (vph)	57	78	1792	55	154	1553
Future Volume (vph)	57	78	1792	55	154	1553
Ideal Flow (vphpl)	1900	1900	1900	1900	1900	1900
Total Lost time (s)	4.0	4.0	4.0	4.0	4.0	4.0
Lane Util. Factor	1.00	1.00	0.95	1.00	1.00	0.91
Frpb, ped/bikes	1.00	0.99	1.00	1.00	1.00	1.00
Flpb, ped/bikes	1.00	1.00	1.00	1.00	1.00	1.00
Frt	1.00	0.85	1.00	0.85	1.00	1.00
Flt Protected	0.95	1.00	1.00	1.00	0.95	1.00
Satd. Flow (prot)	1770	1562	3539	1583	1770	5085
Flt Permitted	0.95	1.00	1.00	1.00	0.95	1.00
Satd. Flow (perm)	1770	1562	3539	1583	1770	5085
Peak-hour factor, PHF	0.92	0.92	0.92	0.92	0.92	0.92
Adj. Flow (vph)	62	85	1948	60	167	1688
RTOR Reduction (vph)	0	76	0	10	0	0
Lane Group Flow (vph)	62	9	1948	50	167	1688
Confl. Peds. (#/hr)		3			2	
Turn Type	Prot	Perm	NA	Perm	Prot	NA
Protected Phases	8		2		1	6
Permitted Phases		8		2		
Actuated Green, G (s)	6.2	6.2	37.4	37.4	5.0	46.4
Effective Green, g (s)	6.2	6.2	37.4	37.4	5.0	46.4
Actuated g/C Ratio	0.10	0.10	0.62	0.62	0.08	0.77
Clearance Time (s)	4.0	4.0	4.0	4.0	4.0	4.0
Vehicle Extension (s)	3.0	3.0	3.0	3.0	3.0	3.0
Lane Grp Cap (vph)	181	159	2184	976	146	3893
v/s Ratio Prot	c0.04		c0.55		c0.09	0.33
v/s Ratio Perm		0.01		0.03		
v/c Ratio	0.34	0.05	0.89	0.05	1.14	0.43
Uniform Delay, d1	25.3	24.6	9.9	4.6	27.8	2.5
Progression Factor	1.00	1.00	1.00	1.00	1.00	1.00
Incremental Delay, d2	1.1	0.1	6.1	0.1	118.3	0.4
Delay (s)	26.4	24.7	15.9	4.7	146.1	2.8
Level of Service	C	C	B	A	F	A
Approach Delay (s)	25.4		15.6			15.7
Approach LOS	C		B			B

Intersection Summary			
HCM 2000 Control Delay	16.0	HCM 2000 Level of Service	B
HCM 2000 Volume to Capacity ratio	0.85		
Actuated Cycle Length (s)	60.6	Sum of lost time (s)	12.0
Intersection Capacity Utilization	73.9%	ICU Level of Service	D
Analysis Period (min)	15		
c Critical Lane Group			

Existing PM Peak Hour  
4: Mission Blvd & Arrowhead Way





















01/21/2021

												
Movement	EBL	EBT	EBR	WBL	WBT	WBR	NBL	NBT	NBR	SBL	SBT	SBR
Lane Configurations								 			 	
Traffic Volume (vph)	11	4	38	18	12	22	87	1874	21	71	1541	25
Future Volume (vph)	11	4	38	18	12	22	87	1874	21	71	1541	25
Ideal Flow (vphpl)	1900	1900	1900	1900	1900	1900	1900	1900	1900	1900	1900	1900
Total Lost time (s)	4.0	4.0		4.0	4.0		4.0	4.0		4.0	4.0	
Lane Util. Factor	1.00	1.00		1.00	1.00		1.00	0.95		1.00	0.95	
Frbp, ped/bikes	1.00	0.98		1.00	1.00		1.00	1.00		1.00	1.00	
Flpb, ped/bikes	1.00	1.00		0.99	1.00		1.00	1.00		1.00	1.00	
Frt	1.00	0.86		1.00	0.90		1.00	1.00		1.00	1.00	
Flt Protected	0.95	1.00		0.95	1.00		0.95	1.00		0.95	1.00	
Satd. Flow (prot)	1770	1581		1758	1682		1770	3532		1770	3529	
Flt Permitted	0.93	1.00		0.93	1.00		0.95	1.00		0.95	1.00	
Satd. Flow (perm)	1733	1581		1722	1682		1770	3532		1770	3529	
Peak-hour factor, PHF	0.92	0.92	0.92	0.92	0.92	0.92	0.92	0.92	0.92	0.92	0.92	0.92
Adj. Flow (vph)	12	4	41	20	13	24	95	2037	23	77	1675	27
RTOR Reduction (vph)	0	38	0	0	22	0	0	1	0	0	1	0
Lane Group Flow (vph)	12	7	0	20	15	0	95	2059	0	77	1701	0
Confl. Peds. (#/hr)			10	10			8		8	8		8
Turn Type	Perm	NA		Perm	NA		Prot	NA		Prot	NA	
Protected Phases		4			8		5	2		1	6	
Permitted Phases	4			8								
Actuated Green, G (s)	4.3	4.3		4.3	4.3		5.0	47.9		4.0	46.9	
Effective Green, g (s)	4.3	4.3		4.3	4.3		5.0	47.9		4.0	46.9	
Actuated g/C Ratio	0.06	0.06		0.06	0.06		0.07	0.70		0.06	0.69	
Clearance Time (s)	4.0	4.0		4.0	4.0		4.0	4.0		4.0	4.0	
Vehicle Extension (s)	3.0	3.0		3.0	3.0		3.0	3.0		3.0	3.0	
Lane Grp Cap (vph)	109	99		108	106		129	2480		103	2426	
v/s Ratio Prot		0.00			0.01		c0.05	c0.58		0.04	0.48	
v/s Ratio Perm	0.01			c0.01								
v/c Ratio	0.11	0.07		0.19	0.14		0.74	0.83		0.75	0.70	
Uniform Delay, d1	30.1	30.1		30.3	30.2		31.0	7.2		31.6	6.4	
Progression Factor	1.00	1.00		1.00	1.00		1.00	1.00		1.00	1.00	
Incremental Delay, d2	0.4	0.3		0.8	0.6		19.5	3.4		25.2	1.7	
Delay (s)	30.6	30.3		31.1	30.8		50.4	10.7		56.8	8.1	
Level of Service	C	C		C	C		D	B		E	A	
Approach Delay (s)		30.4			30.9			12.4			10.3	
Approach LOS		C			C			B			B	
<b>Intersection Summary</b>												
HCM 2000 Control Delay			12.0				HCM 2000 Level of Service				B	
HCM 2000 Volume to Capacity ratio			0.79									
Actuated Cycle Length (s)			68.2				Sum of lost time (s)			12.0		
Intersection Capacity Utilization			78.7%				ICU Level of Service			D		
Analysis Period (min)			15									
c Critical Lane Group												

# Background AM Peak Hour

## 1: Arrowhead Way/Dixon St & Industrial Pkwy























01/21/2021

												
Movement	EBL	EBT	EBR	WBL	WBT	WBR	NBL	NBT	NBR	SBL	SBT	SBR
Lane Configurations												
Traffic Volume (vph)	240	682	40	16	1126	64	106	39	21	128	29	315
Future Volume (vph)	240	682	40	16	1126	64	106	39	21	128	29	315
Ideal Flow (vphpl)	1900	1900	1900	1900	1900	1900	1900	1900	1900	1900	1900	1900
Total Lost time (s)	4.0	5.0		4.0	5.0		5.0	5.0			5.0	5.0
Lane Util. Factor	1.00	0.95		1.00	0.95		1.00	1.00			1.00	1.00
Frbp, ped/bikes	1.00	1.00		1.00	1.00		1.00	0.99			1.00	0.98
Flpb, ped/bikes	1.00	1.00		1.00	1.00		1.00	1.00			0.99	1.00
Frt	1.00	0.99		1.00	0.99		1.00	0.95			1.00	0.85
Flt Protected	0.95	1.00		0.95	1.00		0.95	1.00			0.96	1.00
Satd. Flow (prot)	1770	3505		1766	3504		1762	1750			1777	1555
Flt Permitted	0.95	1.00		0.95	1.00		0.63	1.00			0.72	1.00
Satd. Flow (perm)	1770	3505		1766	3504		1177	1750			1335	1555
Peak-hour factor, PHF	0.92	0.92	0.92	0.92	0.92	0.92	0.92	0.92	0.92	0.92	0.92	0.92
Adj. Flow (vph)	261	741	43	17	1224	70	115	42	23	139	32	342
RTOR Reduction (vph)	0	4	0	0	5	0	0	18	0	0	0	180
Lane Group Flow (vph)	261	780	0	17	1289	0	115	47	0	0	171	162
Confl. Peds. (#/hr)	8		4	4		8	8		14	14		8
Turn Type	Prot	NA		Prot	NA		Perm	NA		Perm	NA	Perm
Protected Phases	7	4		3	8			2			6	
Permitted Phases							2			6		6
Actuated Green, G (s)	10.1	35.7		0.9	26.5		13.9	13.9			13.9	13.9
Effective Green, g (s)	10.1	35.7		0.9	26.5		13.9	13.9			13.9	13.9
Actuated g/C Ratio	0.16	0.55		0.01	0.41		0.22	0.22			0.22	0.22
Clearance Time (s)	4.0	5.0		4.0	5.0		5.0	5.0			5.0	5.0
Vehicle Extension (s)	3.0	3.0		3.0	3.0		3.0	3.0			3.0	3.0
Lane Grp Cap (vph)	277	1939		24	1439		253	377			287	335
v/s Ratio Prot	c0.15	0.22		0.01	c0.37			0.03				
v/s Ratio Perm							0.10				c0.13	0.10
v/c Ratio	0.94	0.40		0.71	0.90		0.45	0.12			0.60	0.48
Uniform Delay, d1	26.9	8.3		31.7	17.7		22.0	20.4			22.8	22.2
Progression Factor	1.00	1.00		1.00	1.00		1.00	1.00			1.00	1.00
Incremental Delay, d2	38.6	0.1		65.6	7.6		1.3	0.1			3.3	1.1
Delay (s)	65.5	8.4		97.3	25.3		23.3	20.5			26.1	23.3
Level of Service	E	A		F	C		C	C			C	C
Approach Delay (s)		22.7			26.3			22.3			24.2	
Approach LOS		C			C			C			C	
<b>Intersection Summary</b>												
HCM 2000 Control Delay			24.5			HCM 2000 Level of Service					C	
HCM 2000 Volume to Capacity ratio			0.82									
Actuated Cycle Length (s)			64.5			Sum of lost time (s)			14.0			
Intersection Capacity Utilization			78.6%			ICU Level of Service					D	
Analysis Period (min)			15									
c Critical Lane Group												

## Background AM Peak Hour

### 2: Mission Blvd & Industrial Pkwy/Alquire Pkwy

01/21/2021

												
Movement	EBL	EBT	EBR	WBL	WBT	WBR	NBL	NBT	NBR	SBL	SBT	SBR
Lane Configurations												
Traffic Volume (vph)	347	70	427	13	140	150	531	1132	3	56	1548	432
Future Volume (vph)	347	70	427	13	140	150	531	1132	3	56	1548	432
Ideal Flow (vphpl)	1900	1900	1900	1900	1900	1900	1900	1900	1900	1900	1900	1900
Total Lost time (s)	4.0	4.0	4.0	4.0	4.0	4.0	4.0	4.0		4.0	4.0	
Lane Util. Factor	0.97	0.91	0.91	1.00	0.95	1.00	0.97	0.91		1.00	0.91	
Frbp, ped/bikes	1.00	1.00	1.00	1.00	1.00	0.99	1.00	1.00		1.00	1.00	
Flpb, ped/bikes	1.00	1.00	1.00	1.00	1.00	1.00	1.00	1.00		1.00	1.00	
Frt	1.00	0.89	0.85	1.00	1.00	0.85	1.00	1.00		1.00	0.97	
Flt Protected	0.95	1.00	1.00	0.95	1.00	1.00	0.95	1.00		0.95	1.00	
Satd. Flow (prot)	3433	3007	1441	1770	3539	1563	3433	5083		1770	4904	
Flt Permitted	0.95	1.00	1.00	0.95	1.00	1.00	0.95	1.00		0.95	1.00	
Satd. Flow (perm)	3433	3007	1441	1770	3539	1563	3433	5083		1770	4904	
Peak-hour factor, PHF	0.92	0.92	0.92	0.92	0.92	0.92	0.92	0.92	0.92	0.92	0.92	0.92
Adj. Flow (vph)	377	76	464	14	152	163	577	1230	3	61	1683	470
RTOR Reduction (vph)	0	181	181	0	0	141	0	0	0	0	33	0
Lane Group Flow (vph)	377	127	51	14	152	22	577	1233	0	61	2120	0
Confl. Peds. (#/hr)	1					1	2		4	4		2
Turn Type	Prot	NA	Perm	Prot	NA	Perm	Prot	NA		Prot	NA	
Protected Phases	7	4		3	8		5	2		1	6	
Permitted Phases			4			8						
Actuated Green, G (s)	11.0	23.3	23.3	0.8	13.1	13.1	18.0	60.0		6.9	48.9	
Effective Green, g (s)	11.0	23.3	23.3	0.8	13.1	13.1	18.0	60.0		6.9	48.9	
Actuated g/C Ratio	0.10	0.22	0.22	0.01	0.12	0.12	0.17	0.56		0.06	0.46	
Clearance Time (s)	4.0	4.0	4.0	4.0	4.0	4.0	4.0	4.0		4.0	4.0	
Vehicle Extension (s)	3.0	3.0	3.0	3.0	3.0	3.0	3.0	3.0		3.0	3.0	
Lane Grp Cap (vph)	352	654	313	13	433	191	577	2850		114	2241	
v/s Ratio Prot	c0.11	0.04		0.01	c0.04		c0.17	0.24		0.03	c0.43	
v/s Ratio Perm			0.04			0.01						
v/c Ratio	1.07	0.19	0.16	1.08	0.35	0.11	1.00	0.43		0.54	0.95	
Uniform Delay, d1	48.0	34.2	33.9	53.1	43.1	41.8	44.5	13.6		48.5	27.8	
Progression Factor	1.00	1.00	1.00	1.00	1.00	1.00	1.00	1.00		1.00	1.00	
Incremental Delay, d2	68.1	0.1	0.2	276.9	0.5	0.3	37.5	0.5		4.8	10.0	
Delay (s)	116.1	34.3	34.2	330.0	43.5	42.0	82.0	14.1		53.3	37.8	
Level of Service	F	C	C	F	D	D	F	B		D	D	
Approach Delay (s)		67.9			55.0			35.7			38.2	
Approach LOS		E			D			D			D	
<b>Intersection Summary</b>												
HCM 2000 Control Delay			43.6		HCM 2000 Level of Service						D	
HCM 2000 Volume to Capacity ratio			0.89									
Actuated Cycle Length (s)			107.0		Sum of lost time (s)						16.0	
Intersection Capacity Utilization			89.0%		ICU Level of Service						E	
Analysis Period (min)			15									
Description: 29827 Mission Blvd												
c Critical Lane Group												



Background AM Peak Hour  
3: Mission Blvd & Garin Ave

01/21/2021

























Movement	WBL	WBR	NBT	NBR	SBL	SBT
Lane Configurations						
Traffic Volume (vph)	65	105	1383	35	67	2042
Future Volume (vph)	65	105	1383	35	67	2042
Ideal Flow (vphpl)	1900	1900	1900	1900	1900	1900
Total Lost time (s)	4.0	4.0	4.0	4.0	4.0	4.0
Lane Util. Factor	1.00	1.00	0.95	1.00	1.00	0.91
Frpb, ped/bikes	1.00	0.99	1.00	1.00	1.00	1.00
Flpb, ped/bikes	1.00	1.00	1.00	1.00	1.00	1.00
Frt	1.00	0.85	1.00	0.85	1.00	1.00
Flt Protected	0.95	1.00	1.00	1.00	0.95	1.00
Satd. Flow (prot)	1770	1562	3539	1583	1770	5085
Flt Permitted	0.95	1.00	1.00	1.00	0.95	1.00
Satd. Flow (perm)	1770	1562	3539	1583	1770	5085
Peak-hour factor, PHF	0.92	0.92	0.92	0.92	0.92	0.92
Adj. Flow (vph)	71	114	1503	38	73	2220
RTOR Reduction (vph)	0	99	0	8	0	0
Lane Group Flow (vph)	71	15	1503	30	73	2220
Confl. Peds. (#/hr)		3				
Turn Type	Prot	Perm	NA	Perm	Prot	NA
Protected Phases	8		2		1	6
Permitted Phases		8		2		
Actuated Green, G (s)	6.8	6.8	40.9	40.9	4.0	48.9
Effective Green, g (s)	6.8	6.8	40.9	40.9	4.0	48.9
Actuated g/C Ratio	0.11	0.11	0.64	0.64	0.06	0.77
Clearance Time (s)	4.0	4.0	4.0	4.0	4.0	4.0
Vehicle Extension (s)	3.0	3.0	3.0	3.0	3.0	3.0
Lane Grp Cap (vph)	188	166	2272	1016	111	3903
v/s Ratio Prot	c0.04		c0.42		0.04	c0.44
v/s Ratio Perm		0.01		0.02		
v/c Ratio	0.38	0.09	0.66	0.03	0.66	0.57
Uniform Delay, d1	26.5	25.7	7.1	4.2	29.2	3.1
Progression Factor	1.00	1.00	1.00	1.00	1.00	1.00
Incremental Delay, d2	1.3	0.2	1.5	0.1	13.2	0.6
Delay (s)	27.8	25.9	8.6	4.2	42.4	3.7
Level of Service	C	C	A	A	D	A
Approach Delay (s)	26.6		8.5			4.9
Approach LOS	C		A			A

Intersection Summary			
HCM 2000 Control Delay	7.3	HCM 2000 Level of Service	A
HCM 2000 Volume to Capacity ratio	0.63		
Actuated Cycle Length (s)	63.7	Sum of lost time (s)	12.0
Intersection Capacity Utilization	58.1%	ICU Level of Service	B
Analysis Period (min)	15		
c Critical Lane Group			

## Background AM Peak Hour





















### 4: Mission Blvd & Arrowhead Way

01/21/2021

													
Movement	EBL	EBT	EBR	WBL	WBT	WBR	NBL	NBT	NBR	SBL	SBT	SBR	
Lane Configurations													
Traffic Volume (vph)	22	21	68	17	11	35	37	1312	2	27	1908	12	
Future Volume (vph)	22	21	68	17	11	35	37	1312	2	27	1908	12	
Ideal Flow (vphpl)	1900	1900	1900	1900	1900	1900	1900	1900	1900	1900	1900	1900	
Total Lost time (s)	4.0	4.0		4.0	4.0		4.0	4.0		4.0	4.0		
Lane Util. Factor	1.00	1.00		1.00	1.00		1.00	0.95		1.00	0.95		
Frbp, ped/bikes	1.00	0.99		1.00	1.00		1.00	1.00		1.00	1.00		
Flpb, ped/bikes	1.00	1.00		1.00	1.00		1.00	1.00		1.00	1.00		
Frt	1.00	0.89		1.00	0.89		1.00	1.00		1.00	1.00		
Flt Protected	0.95	1.00		0.95	1.00		0.95	1.00		0.95	1.00		
Satd. Flow (prot)	1770	1633		1767	1650		1770	3538		1770	3535		
Flt Permitted	0.72	1.00		0.69	1.00		0.95	1.00		0.95	1.00		
Satd. Flow (perm)	1349	1633		1292	1650		1770	3538		1770	3535		
Peak-hour factor, PHF	0.92	0.92	0.92	0.92	0.92	0.92	0.92	0.92	0.92	0.92	0.92	0.92	
Adj. Flow (vph)	24	23	74	18	12	38	40	1426	2	29	2074	13	
RTOR Reduction (vph)	0	68	0	0	35	0	0	0	0	0	0	0	
Lane Group Flow (vph)	24	29	0	18	15	0	40	1428	0	29	2087	0	
Confl. Peds. (#/hr)			2	2			3		1	1		3	
Turn Type	Perm	NA		Perm	NA		Prot	NA		Prot	NA		
Protected Phases		4			8		5	2		1		6	
Permitted Phases	4			8									
Actuated Green, G (s)	5.9	5.9		5.9	5.9		2.4	50.6		1.6	49.8		
Effective Green, g (s)	5.9	5.9		5.9	5.9		2.4	50.6		1.6	49.8		
Actuated g/C Ratio	0.08	0.08		0.08	0.08		0.03	0.72		0.02	0.71		
Clearance Time (s)	4.0	4.0		4.0	4.0		4.0	4.0		4.0	4.0		
Vehicle Extension (s)	3.0	3.0		3.0	3.0		3.0	3.0		3.0	3.0		
Lane Grp Cap (vph)	113	137		108	138		60	2553		40	2511		
v/s Ratio Prot		c0.02			0.01		c0.02	0.40		0.02	c0.59		
v/s Ratio Perm	0.02			0.01									
v/c Ratio	0.21	0.21		0.17	0.11		0.67	0.56		0.72	0.83		
Uniform Delay, d1	29.9	29.9		29.8	29.7		33.5	4.5		34.0	7.2		
Progression Factor	1.00	1.00		1.00	1.00		1.00	1.00		1.00	1.00		
Incremental Delay, d2	0.9	0.8		0.7	0.4		24.5	0.9		48.4	3.4		
Delay (s)	30.9	30.7		30.5	30.0		58.0	5.4		82.5	10.6		
Level of Service	C	C		C	C		E	A		F	B		
Approach Delay (s)		30.7			30.2			6.9			11.5		
Approach LOS		C			C			A			B		
<b>Intersection Summary</b>													
HCM 2000 Control Delay			10.7				HCM 2000 Level of Service				B		
HCM 2000 Volume to Capacity ratio			0.76										
Actuated Cycle Length (s)			70.1				Sum of lost time (s)			12.0			
Intersection Capacity Utilization			68.8%				ICU Level of Service			C			
Analysis Period (min)			15										
c	Critical Lane Group												

























Background PM Peak Hour  
1: Arrowhead Way/Dixon St & Industrial Pkwy

01/21/2021

												
Movement	EBL	EBT	EBR	WBL	WBT	WBR	NBL	NBT	NBR	SBL	SBT	SBR
Lane Configurations												
Traffic Volume (vph)	246	1297	80	28	776	99	70	25	11	65	19	254
Future Volume (vph)	246	1297	80	28	776	99	70	25	11	65	19	254
Ideal Flow (vphpl)	1900	1900	1900	1900	1900	1900	1900	1900	1900	1900	1900	1900
Total Lost time (s)	4.0	5.0		4.0	5.0		5.0	5.0			5.0	5.0
Lane Util. Factor	1.00	0.95		1.00	0.95		1.00	1.00			1.00	1.00
Frbp, ped/bikes	1.00	1.00		1.00	1.00		1.00	0.99			1.00	0.98
Flpb, ped/bikes	1.00	1.00		1.00	1.00		1.00	1.00			1.00	1.00
Frt	1.00	0.99		1.00	0.98		1.00	0.95			1.00	0.85
Flt Protected	0.95	1.00		0.95	1.00		0.95	1.00			0.96	1.00
Satd. Flow (prot)	1770	3501		1770	3468		1762	1768			1788	1556
Flt Permitted	0.95	1.00		0.95	1.00		0.70	1.00			0.75	1.00
Satd. Flow (perm)	1770	3501		1770	3468		1293	1768			1391	1556
Peak-hour factor, PHF	0.92	0.92	0.92	0.92	0.92	0.92	0.92	0.92	0.92	0.92	0.92	0.92
Adj. Flow (vph)	267	1410	87	30	843	108	76	27	12	71	21	276
RTOR Reduction (vph)	0	4	0	0	11	0	0	10	0	0	0	205
Lane Group Flow (vph)	267	1493	0	30	940	0	76	29	0	0	92	71
Confl. Peds. (#/hr)	5		9	9		5	8		7	7		8
Turn Type	Prot	NA		Prot	NA		Perm	NA		Perm	NA	Perm
Protected Phases	7	4		3	8			2			6	
Permitted Phases							2			6		6
Actuated Green, G (s)	10.1	31.6		1.8	23.3		9.5	9.5			9.5	9.5
Effective Green, g (s)	10.1	31.6		1.8	23.3		9.5	9.5			9.5	9.5
Actuated g/C Ratio	0.18	0.56		0.03	0.41		0.17	0.17			0.17	0.17
Clearance Time (s)	4.0	5.0		4.0	5.0		5.0	5.0			5.0	5.0
Vehicle Extension (s)	3.0	3.0		3.0	3.0		3.0	3.0			3.0	3.0
Lane Grp Cap (vph)	314	1944		55	1420		215	295			232	259
v/s Ratio Prot	c0.15	c0.43		0.02	0.27			0.02				
v/s Ratio Perm							0.06				c0.07	0.05
v/c Ratio	0.85	0.77		0.55	0.66		0.35	0.10			0.40	0.27
Uniform Delay, d1	22.7	9.8		27.1	13.6		21.0	20.1			21.1	20.7
Progression Factor	1.00	1.00		1.00	1.00		1.00	1.00			1.00	1.00
Incremental Delay, d2	19.2	1.9		10.6	1.2		1.0	0.1			1.1	0.6
Delay (s)	41.9	11.7		37.8	14.8		22.0	20.2			22.3	21.3
Level of Service	D	B		D	B		C	C			C	C
Approach Delay (s)		16.3			15.5			21.4			21.5	
Approach LOS		B			B			C			C	
<b>Intersection Summary</b>												
HCM 2000 Control Delay			16.8									B
HCM 2000 Volume to Capacity ratio			0.75									
Actuated Cycle Length (s)			56.9						14.0			
Intersection Capacity Utilization			68.2%									C
Analysis Period (min)			15									
c Critical Lane Group												

















## Background PM Peak Hour 2: Mission Blvd & Industrial Pkwy/Alquire Pkwy

01/21/2021

													
Movement	EBL	EBT	EBR	WBL	WBT	WBR	NBL	NBT	NBR	SBL	SBT	SBR	
Lane Configurations													
Traffic Volume (vph)	617	150	511	2	68	65	350	1537	15	87	1165	332	
Future Volume (vph)	617	150	511	2	68	65	350	1537	15	87	1165	332	
Ideal Flow (vphpl)	1900	1900	1900	1900	1900	1900	1900	1900	1900	1900	1900	1900	
Total Lost time (s)	4.0	4.0	4.0	4.0	4.0	4.0	4.0	4.0		4.0	4.0		
Lane Util. Factor	0.97	0.91	0.91	1.00	0.95	1.00	0.97	0.91		1.00	0.91		
Frbp, ped/bikes	1.00	1.00	1.00	1.00	1.00	0.99	1.00	1.00		1.00	0.99		
Flpb, ped/bikes	1.00	1.00	1.00	1.00	1.00	1.00	1.00	1.00		1.00	1.00		
Frt	1.00	0.91	0.85	1.00	1.00	0.85	1.00	1.00		1.00	0.97		
Flt Protected	0.95	1.00	1.00	0.95	1.00	1.00	0.95	1.00		0.95	1.00		
Satd. Flow (prot)	3433	3070	1441	1770	3539	1563	3433	5077		1770	4889		
Flt Permitted	0.95	1.00	1.00	0.95	1.00	1.00	0.95	1.00		0.95	1.00		
Satd. Flow (perm)	3433	3070	1441	1770	3539	1563	3433	5077		1770	4889		
Peak-hour factor, PHF	0.92	0.92	0.92	0.92	0.92	0.92	0.92	0.92	0.92	0.92	0.92	0.92	
Adj. Flow (vph)	671	163	555	2	74	71	380	1671	16	95	1266	361	
RTOR Reduction (vph)	0	187	186	0	0	64	0	1	0	0	35	0	
Lane Group Flow (vph)	671	254	91	2	74	7	380	1686	0	95	1592	0	
Confl. Peds. (#/hr)	1						1	15		3	3	15	
Turn Type	Prot	NA	Perm	Prot	NA	Perm	Prot	NA		Prot	NA		
Protected Phases	7	4		3	8		5	2		1	6		
Permitted Phases			4			8							
Actuated Green, G (s)	24.0	33.9	33.9	0.8	10.7	10.7	14.0	44.2		8.8	39.0		
Effective Green, g (s)	24.0	33.9	33.9	0.8	10.7	10.7	14.0	44.2		8.8	39.0		
Actuated g/C Ratio	0.23	0.33	0.33	0.01	0.10	0.10	0.14	0.43		0.08	0.38		
Clearance Time (s)	4.0	4.0	4.0	4.0	4.0	4.0	4.0	4.0		4.0	4.0		
Vehicle Extension (s)	3.0	3.0	3.0	3.0	3.0	3.0	3.0	3.0		3.0	3.0		
Lane Grp Cap (vph)	794	1003	471	13	365	161	463	2163		150	1838		
v/s Ratio Prot	c0.20	c0.08		0.00	0.02		c0.11	0.33		0.05	c0.33		
v/s Ratio Perm			0.06			0.00							
v/c Ratio	0.85	0.25	0.19	0.15	0.20	0.05	0.82	0.78		0.63	0.87		
Uniform Delay, d1	38.1	25.6	25.1	51.1	42.6	41.9	43.6	25.6		45.9	29.9		
Progression Factor	1.00	1.00	1.00	1.00	1.00	1.00	1.00	1.00		1.00	1.00		
Incremental Delay, d2	8.2	0.1	0.2	5.5	0.3	0.1	11.1	2.9		8.4	5.8		
Delay (s)	46.3	25.7	25.3	56.6	42.9	42.0	54.8	28.4		54.3	35.7		
Level of Service	D	C	C	E	D	D	D	C		D	D		
Approach Delay (s)		35.6			42.6			33.3			36.7		
Approach LOS		D			D			C			D		
<b>Intersection Summary</b>													
HCM 2000 Control Delay			35.3									HCM 2000 Level of Service	D
HCM 2000 Volume to Capacity ratio			0.79										
Actuated Cycle Length (s)			103.7									Sum of lost time (s)	16.0
Intersection Capacity Utilization			74.5%									ICU Level of Service	D
Analysis Period (min)			15										
c Critical Lane Group													

### Background PM Peak Hour 3: Mission Blvd & Garin Ave

01/21/2021

						
Movement	WBL	WBR	NBT	NBR	SBL	SBT
Lane Configurations			 			   
Traffic Volume (vph)	57	78	1798	55	154	1557
Future Volume (vph)	57	78	1798	55	154	1557
Ideal Flow (vphpl)	1900	1900	1900	1900	1900	1900
Total Lost time (s)	4.0	4.0	4.0	4.0	4.0	4.0
Lane Util. Factor	1.00	1.00	0.95	1.00	1.00	0.91
Frpb, ped/bikes	1.00	0.99	1.00	1.00	1.00	1.00
Flpb, ped/bikes	1.00	1.00	1.00	1.00	1.00	1.00
Frt	1.00	0.85	1.00	0.85	1.00	1.00
Flt Protected	0.95	1.00	1.00	1.00	0.95	1.00
Satd. Flow (prot)	1770	1562	3539	1583	1770	5085
Flt Permitted	0.95	1.00	1.00	1.00	0.95	1.00
Satd. Flow (perm)	1770	1562	3539	1583	1770	5085
Peak-hour factor, PHF	0.92	0.92	0.92	0.92	0.92	0.92
Adj. Flow (vph)	62	85	1954	60	167	1692
RTOR Reduction (vph)	0	76	0	10	0	0
Lane Group Flow (vph)	62	9	1954	50	167	1692
Confl. Peds. (#/hr)		3			2	
Turn Type	Prot	Perm	NA	Perm	Prot	NA
Protected Phases	8		2		1	6
Permitted Phases		8		2		
Actuated Green, G (s)	6.2	6.2	37.4	37.4	5.0	46.4
Effective Green, g (s)	6.2	6.2	37.4	37.4	5.0	46.4
Actuated g/C Ratio	0.10	0.10	0.62	0.62	0.08	0.77
Clearance Time (s)	4.0	4.0	4.0	4.0	4.0	4.0
Vehicle Extension (s)	3.0	3.0	3.0	3.0	3.0	3.0
Lane Grp Cap (vph)	181	159	2184	976	146	3893
v/s Ratio Prot	c0.04		c0.55		c0.09	0.33
v/s Ratio Perm		0.01		0.03		
v/c Ratio	0.34	0.05	0.89	0.05	1.14	0.43
Uniform Delay, d1	25.3	24.6	9.9	4.6	27.8	2.5
Progression Factor	1.00	1.00	1.00	1.00	1.00	1.00
Incremental Delay, d2	1.1	0.1	6.2	0.1	118.3	0.4
Delay (s)	26.4	24.7	16.1	4.7	146.1	2.8
Level of Service	C	C	B	A	F	A
Approach Delay (s)	25.4		15.8			15.7
Approach LOS	C		B			B
<b>Intersection Summary</b>						
HCM 2000 Control Delay			16.1		HCM 2000 Level of Service	B
HCM 2000 Volume to Capacity ratio			0.85			
Actuated Cycle Length (s)			60.6		Sum of lost time (s)	12.0
Intersection Capacity Utilization			74.1%		ICU Level of Service	D
Analysis Period (min)			15			
c Critical Lane Group						

## Background PM Peak Hour

### 4: Mission Blvd & Arrowhead Way

01/21/2021























Movement	EBL	EBT	EBR	WBL	WBT	WBR	NBL	NBT	NBR	SBL	SBT	SBR
Lane Configurations												
Traffic Volume (vph)	11	4	38	18	12	22	87	1880	21	71	1545	25
Future Volume (vph)	11	4	38	18	12	22	87	1880	21	71	1545	25
Ideal Flow (vphpl)	1900	1900	1900	1900	1900	1900	1900	1900	1900	1900	1900	1900
Total Lost time (s)	4.0	4.0		4.0	4.0		4.0	4.0		4.0	4.0	
Lane Util. Factor	1.00	1.00		1.00	1.00		1.00	0.95		1.00	0.95	
Frbp, ped/bikes	1.00	0.98		1.00	1.00		1.00	1.00		1.00	1.00	
Flpb, ped/bikes	1.00	1.00		0.99	1.00		1.00	1.00		1.00	1.00	
Frt	1.00	0.86		1.00	0.90		1.00	1.00		1.00	1.00	
Flt Protected	0.95	1.00		0.95	1.00		0.95	1.00		0.95	1.00	
Satd. Flow (prot)	1770	1581		1758	1682		1770	3532		1770	3529	
Flt Permitted	0.93	1.00		0.93	1.00		0.95	1.00		0.95	1.00	
Satd. Flow (perm)	1733	1581		1722	1682		1770	3532		1770	3529	
Peak-hour factor, PHF	0.92	0.92	0.92	0.92	0.92	0.92	0.92	0.92	0.92	0.92	0.92	0.92
Adj. Flow (vph)	12	4	41	20	13	24	95	2043	23	77	1679	27
RTOR Reduction (vph)	0	38	0	0	22	0	0	1	0	0	1	0
Lane Group Flow (vph)	12	7	0	20	15	0	95	2065	0	77	1705	0
Confl. Peds. (#/hr)			10	10			8		8	8		8
Turn Type	Perm	NA		Perm	NA		Prot	NA		Prot	NA	
Protected Phases		4			8		5	2		1	6	
Permitted Phases	4			8								
Actuated Green, G (s)	4.3	4.3		4.3	4.3		5.0	47.9		4.0	46.9	
Effective Green, g (s)	4.3	4.3		4.3	4.3		5.0	47.9		4.0	46.9	
Actuated g/C Ratio	0.06	0.06		0.06	0.06		0.07	0.70		0.06	0.69	
Clearance Time (s)	4.0	4.0		4.0	4.0		4.0	4.0		4.0	4.0	
Vehicle Extension (s)	3.0	3.0		3.0	3.0		3.0	3.0		3.0	3.0	
Lane Grp Cap (vph)	109	99		108	106		129	2480		103	2426	
v/s Ratio Prot		0.00			0.01		c0.05	c0.58		0.04	0.48	
v/s Ratio Perm	0.01			c0.01								
v/c Ratio	0.11	0.07		0.19	0.14		0.74	0.83		0.75	0.70	
Uniform Delay, d1	30.1	30.1		30.3	30.2		31.0	7.3		31.6	6.4	
Progression Factor	1.00	1.00		1.00	1.00		1.00	1.00		1.00	1.00	
Incremental Delay, d2	0.4	0.3		0.8	0.6		19.5	3.5		25.2	1.7	
Delay (s)	30.6	30.3		31.1	30.8		50.4	10.7		56.8	8.2	
Level of Service	C	C		C	C		D	B		E	A	
Approach Delay (s)		30.4			30.9			12.5			10.3	
Approach LOS		C			C			B			B	

#### Intersection Summary

HCM 2000 Control Delay	12.0	HCM 2000 Level of Service	B
HCM 2000 Volume to Capacity ratio	0.79		
Actuated Cycle Length (s)	68.2	Sum of lost time (s)	12.0
Intersection Capacity Utilization	78.9%	ICU Level of Service	D
Analysis Period (min)	15		
c Critical Lane Group			

Background + Project AM Peak Hour  
1: Arrowhead Way/Dixon St & Industrial Pkwy

01/21/2021

												
Movement	EBL	EBT	EBR	WBL	WBT	WBR	NBL	NBT	NBR	SBL	SBT	SBR
Lane Configurations												
Traffic Volume (vph)	240	717	40	19	1157	67	106	39	24	131	29	315
Future Volume (vph)	240	717	40	19	1157	67	106	39	24	131	29	315
Ideal Flow (vphpl)	1900	1900	1900	1900	1900	1900	1900	1900	1900	1900	1900	1900
Total Lost time (s)	4.0	5.0		4.0	5.0		5.0	5.0			5.0	5.0
Lane Util. Factor	1.00	0.95		1.00	0.95		1.00	1.00			1.00	1.00
Frbp, ped/bikes	1.00	1.00		1.00	1.00		1.00	0.99			1.00	0.98
Flpb, ped/bikes	1.00	1.00		1.00	1.00		1.00	1.00			0.99	1.00
Frt	1.00	0.99		1.00	0.99		1.00	0.94			1.00	0.85
Flt Protected	0.95	1.00		0.95	1.00		0.95	1.00			0.96	1.00
Satd. Flow (prot)	1770	3506		1766	3504		1762	1741			1776	1555
Flt Permitted	0.95	1.00		0.95	1.00		0.63	1.00			0.72	1.00
Satd. Flow (perm)	1770	3506		1766	3504		1165	1741			1329	1555
Peak-hour factor, PHF	0.92	0.92	0.92	0.92	0.92	0.92	0.92	0.92	0.92	0.92	0.92	0.92
Adj. Flow (vph)	261	779	43	21	1258	73	115	42	26	142	32	342
RTOR Reduction (vph)	0	4	0	0	5	0	0	20	0	0	0	178
Lane Group Flow (vph)	261	818	0	21	1326	0	115	48	0	0	174	164
Confl. Peds. (#/hr)	8		4	4		8	8		14	14		8
Turn Type	Prot	NA		Prot	NA		Perm	NA		Perm	NA	Perm
Protected Phases	7	4		3	8			2			6	
Permitted Phases							2			6		6
Actuated Green, G (s)	10.1	35.7		0.9	26.5		14.1	14.1			14.1	14.1
Effective Green, g (s)	10.1	35.7		0.9	26.5		14.1	14.1			14.1	14.1
Actuated g/C Ratio	0.16	0.55		0.01	0.41		0.22	0.22			0.22	0.22
Clearance Time (s)	4.0	5.0		4.0	5.0		5.0	5.0			5.0	5.0
Vehicle Extension (s)	3.0	3.0		3.0	3.0		3.0	3.0			3.0	3.0
Lane Grp Cap (vph)	276	1934		24	1435		253	379			289	338
v/s Ratio Prot	c0.15	0.23		0.01	c0.38			0.03				
v/s Ratio Perm							0.10				c0.13	0.11
v/c Ratio	0.95	0.42		0.88	0.92		0.45	0.13			0.60	0.48
Uniform Delay, d1	27.0	8.5		31.8	18.1		22.0	20.3			22.8	22.1
Progression Factor	1.00	1.00		1.00	1.00		1.00	1.00			1.00	1.00
Incremental Delay, d2	39.3	0.2		127.4	10.3		1.3	0.2			3.5	1.1
Delay (s)	66.4	8.6		159.2	28.4		23.3	20.5			26.3	23.2
Level of Service	E	A		F	C		C	C			C	C
Approach Delay (s)		22.5			30.4			22.2			24.3	
Approach LOS		C			C			C			C	
<b>Intersection Summary</b>												
HCM 2000 Control Delay			26.2			HCM 2000 Level of Service				C		
HCM 2000 Volume to Capacity ratio			0.84									
Actuated Cycle Length (s)			64.7			Sum of lost time (s)		14.0				
Intersection Capacity Utilization			79.6%			ICU Level of Service				D		
Analysis Period (min)			15									
c	Critical Lane Group											



## Background + Project AM Peak Hour 2: Mission Blvd & Industrial Pkwy/Alquire Pkwy

01/21/2021

















Movement	EBL	EBT	EBR	WBL	WBT	WBR	NBL	NBT	NBR	SBL	SBT	SBR
Lane Configurations												
Traffic Volume (vph)	327	70	427	17	140	150	591	1142	7	56	1575	432
Future Volume (vph)	327	70	427	17	140	150	591	1142	7	56	1575	432
Ideal Flow (vphpl)	1900	1900	1900	1900	1900	1900	1900	1900	1900	1900	1900	1900
Total Lost time (s)	4.0	4.0	4.0	4.0	4.0	4.0	4.0	4.0		4.0	4.0	
Lane Util. Factor	0.97	0.91	0.91	1.00	0.95	1.00	0.97	0.91		1.00	0.91	
Frbp, ped/bikes	1.00	1.00	1.00	1.00	1.00	0.99	1.00	1.00		1.00	1.00	
Flpb, ped/bikes	1.00	1.00	1.00	1.00	1.00	1.00	1.00	1.00		1.00	1.00	
Frt	1.00	0.89	0.85	1.00	1.00	0.85	1.00	1.00		1.00	0.97	
Flt Protected	0.95	1.00	1.00	0.95	1.00	1.00	0.95	1.00		0.95	1.00	
Satd. Flow (prot)	3433	3007	1441	1770	3539	1563	3433	5080		1770	4906	
Flt Permitted	0.95	1.00	1.00	0.95	1.00	1.00	0.95	1.00		0.95	1.00	
Satd. Flow (perm)	3433	3007	1441	1770	3539	1563	3433	5080		1770	4906	
Peak-hour factor, PHF	0.92	0.92	0.92	0.92	0.92	0.92	0.92	0.92	0.92	0.92	0.92	0.92
Adj. Flow (vph)	355	76	464	18	152	163	642	1241	8	61	1712	470
RTOR Reduction (vph)	0	184	184	0	0	141	0	0	0	0	32	0
Lane Group Flow (vph)	355	124	48	18	152	22	642	1249	0	61	2150	0
Confl. Peds. (#/hr)	1					1	2		4	4		2
Turn Type	Prot	NA	Perm	Prot	NA	Perm	Prot	NA		Prot	NA	
Protected Phases	7	4		3	8		5	2		1	6	
Permitted Phases			4			8						
Actuated Green, G (s)	11.0	21.8	21.8	1.6	12.4	12.4	18.0	60.0		6.9	48.9	
Effective Green, g (s)	11.0	21.8	21.8	1.6	12.4	12.4	18.0	60.0		6.9	48.9	
Actuated g/C Ratio	0.10	0.21	0.21	0.02	0.12	0.12	0.17	0.56		0.06	0.46	
Clearance Time (s)	4.0	4.0	4.0	4.0	4.0	4.0	4.0	4.0		4.0	4.0	
Vehicle Extension (s)	3.0	3.0	3.0	3.0	3.0	3.0	3.0	3.0		3.0	3.0	
Lane Grp Cap (vph)	355	616	295	26	412	182	581	2867		114	2256	
v/s Ratio Prot	c0.10	0.04		0.01	c0.04		c0.19	0.25		0.03	c0.44	
v/s Ratio Perm			0.03			0.01						
v/c Ratio	1.00	0.20	0.16	0.69	0.37	0.12	1.10	0.44		0.54	0.95	
Uniform Delay, d1	47.6	35.0	34.7	52.1	43.3	42.1	44.1	13.4		48.1	27.6	
Progression Factor	1.00	1.00	1.00	1.00	1.00	1.00	1.00	1.00		1.00	1.00	
Incremental Delay, d2	47.8	0.2	0.3	57.6	0.6	0.3	69.4	0.5		4.8	10.7	
Delay (s)	95.4	35.2	35.0	109.7	43.9	42.4	113.6	13.9		52.9	38.3	
Level of Service	F	D	C	F	D	D	F	B		D	D	
Approach Delay (s)		59.0			46.7			47.7			38.7	
Approach LOS		E			D			D			D	

### Intersection Summary

HCM 2000 Control Delay	45.8	HCM 2000 Level of Service	D
HCM 2000 Volume to Capacity ratio	0.91		
Actuated Cycle Length (s)	106.3	Sum of lost time (s)	16.0
Intersection Capacity Utilization	91.3%	ICU Level of Service	F
Analysis Period (min)	15		
Description: 29827 Mission Blvd			
c Critical Lane Group			























### Background + Project AM Peak Hour 3: Mission Blvd & Garin Ave

01/21/2021

						
Movement	WBL	WBR	NBT	NBR	SBL	SBT
Lane Configurations			 			   
Traffic Volume (vph)	65	109	1416	35	108	2073
Future Volume (vph)	65	109	1416	35	108	2073
Ideal Flow (vphpl)	1900	1900	1900	1900	1900	1900
Total Lost time (s)	4.0	4.0	4.0	4.0	4.0	4.0
Lane Util. Factor	1.00	1.00	0.95	1.00	1.00	0.91
Frpb, ped/bikes	1.00	0.99	1.00	1.00	1.00	1.00
Flpb, ped/bikes	1.00	1.00	1.00	1.00	1.00	1.00
Frt	1.00	0.85	1.00	0.85	1.00	1.00
Flt Protected	0.95	1.00	1.00	1.00	0.95	1.00
Satd. Flow (prot)	1770	1562	3539	1583	1770	5085
Flt Permitted	0.95	1.00	1.00	1.00	0.95	1.00
Satd. Flow (perm)	1770	1562	3539	1583	1770	5085
Peak-hour factor, PHF	0.92	0.92	0.92	0.92	0.92	0.92
Adj. Flow (vph)	71	118	1539	38	117	2253
RTOR Reduction (vph)	0	98	0	8	0	0
Lane Group Flow (vph)	71	20	1539	30	117	2253
Confl. Peds. (#/hr)		3				
Turn Type	Prot	Perm	NA	Perm	Prot	NA
Protected Phases	8		2		1	6
Permitted Phases		8		2		
Actuated Green, G (s)	6.5	6.5	38.4	38.4	4.0	46.4
Effective Green, g (s)	6.5	6.5	38.4	38.4	4.0	46.4
Actuated g/C Ratio	0.11	0.11	0.63	0.63	0.07	0.76
Clearance Time (s)	4.0	4.0	4.0	4.0	4.0	4.0
Vehicle Extension (s)	3.0	3.0	3.0	3.0	3.0	3.0
Lane Grp Cap (vph)	188	166	2231	998	116	3874
v/s Ratio Prot	c0.04		c0.43		c0.07	0.44
v/s Ratio Perm		0.01		0.02		
v/c Ratio	0.38	0.12	0.69	0.03	1.01	0.58
Uniform Delay, d1	25.3	24.6	7.4	4.2	28.4	3.1
Progression Factor	1.00	1.00	1.00	1.00	1.00	1.00
Incremental Delay, d2	1.3	0.3	1.8	0.1	85.9	0.6
Delay (s)	26.6	24.9	9.1	4.3	114.3	3.7
Level of Service	C	C	A	A	F	A
Approach Delay (s)	25.6		9.0			9.2
Approach LOS	C		A			A
<b>Intersection Summary</b>						
HCM 2000 Control Delay			9.9		HCM 2000 Level of Service	A
HCM 2000 Volume to Capacity ratio			0.67			
Actuated Cycle Length (s)			60.9		Sum of lost time (s)	12.0
Intersection Capacity Utilization			61.2%		ICU Level of Service	B
Analysis Period (min)			15			
c Critical Lane Group						





















## Background + Project AM Peak Hour 4: Mission Blvd & Arrowhead Way

01/21/2021

													
Movement	EBL	EBT	EBR	WBL	WBT	WBR	NBL	NBT	NBR	SBL	SBT	SBR	
Lane Configurations													
Traffic Volume (vph)	25	21	68	17	11	38	37	1339	2	30	1933	15	
Future Volume (vph)	25	21	68	17	11	38	37	1339	2	30	1933	15	
Ideal Flow (vphpl)	1900	1900	1900	1900	1900	1900	1900	1900	1900	1900	1900	1900	
Total Lost time (s)	4.0	4.0		4.0	4.0		4.0	4.0		4.0	4.0		
Lane Util. Factor	1.00	1.00		1.00	1.00		1.00	0.95		1.00	0.95		
Frbp, ped/bikes	1.00	0.99		1.00	1.00		1.00	1.00		1.00	1.00		
Flpb, ped/bikes	1.00	1.00		1.00	1.00		1.00	1.00		1.00	1.00		
Frt	1.00	0.89		1.00	0.88		1.00	1.00		1.00	1.00		
Flt Protected	0.95	1.00		0.95	1.00		0.95	1.00		0.95	1.00		
Satd. Flow (prot)	1770	1633		1767	1647		1770	3538		1770	3535		
Flt Permitted	0.72	1.00		0.69	1.00		0.95	1.00		0.95	1.00		
Satd. Flow (perm)	1346	1633		1292	1647		1770	3538		1770	3535		
Peak-hour factor, PHF	0.92	0.92	0.92	0.92	0.92	0.92	0.92	0.92	0.92	0.92	0.92	0.92	
Adj. Flow (vph)	27	23	74	18	12	41	40	1455	2	33	2101	16	
RTOR Reduction (vph)	0	68	0	0	37	0	0	0	0	0	0	0	
Lane Group Flow (vph)	27	29	0	18	16	0	40	1457	0	33	2117	0	
Confl. Peds. (#/hr)			2	2			3		1	1		3	
Turn Type	Perm	NA		Perm	NA		Prot	NA		Prot	NA		
Protected Phases		4			8		5	2		1	6		
Permitted Phases	4			8									
Actuated Green, G (s)	6.0	6.0		6.0	6.0		2.3	50.4		1.5	49.6		
Effective Green, g (s)	6.0	6.0		6.0	6.0		2.3	50.4		1.5	49.6		
Actuated g/C Ratio	0.09	0.09		0.09	0.09		0.03	0.72		0.02	0.71		
Clearance Time (s)	4.0	4.0		4.0	4.0		4.0	4.0		4.0	4.0		
Vehicle Extension (s)	3.0	3.0		3.0	3.0		3.0	3.0		3.0	3.0		
Lane Grp Cap (vph)	115	140		110	141		58	2551		37	2508		
v/s Ratio Prot		0.02			0.01		c0.02	0.41		0.02	c0.60		
v/s Ratio Perm	c0.02			0.01									
v/c Ratio	0.23	0.21		0.16	0.11		0.69	0.57		0.89	0.84		
Uniform Delay, d1	29.8	29.7		29.6	29.5		33.4	4.6		34.1	7.3		
Progression Factor	1.00	1.00		1.00	1.00		1.00	1.00		1.00	1.00		
Incremental Delay, d2	1.1	0.7		0.7	0.3		29.0	0.9		104.8	3.7		
Delay (s)	30.9	30.5		30.3	29.8		62.5	5.6		138.9	11.0		
Level of Service	C	C		C	C		E	A		F	B		
Approach Delay (s)		30.6			30.0			7.1			13.0		
Approach LOS		C			C			A			B		
<b>Intersection Summary</b>													
HCM 2000 Control Delay			11.6				HCM 2000 Level of Service				B		
HCM 2000 Volume to Capacity ratio			0.77										
Actuated Cycle Length (s)			69.9				Sum of lost time (s)			12.0			
Intersection Capacity Utilization			69.7%				ICU Level of Service			C			
Analysis Period (min)			15										
c Critical Lane Group													

Background + Project PM Peak Hour  
1: Arrowhead Way/Dixon St & Industrial Pkwy

01/21/2021

													
Movement	EBL	EBT	EBR	WBL	WBT	WBR	NBL	NBT	NBR	SBL	SBT	SBR	
Lane Configurations													
Traffic Volume (vph)	246	1306	80	29	788	100	70	25	12	66	19	254	
Future Volume (vph)	246	1306	80	29	788	100	70	25	12	66	19	254	
Ideal Flow (vphpl)	1900	1900	1900	1900	1900	1900	1900	1900	1900	1900	1900	1900	
Total Lost time (s)	4.0	5.0		4.0	5.0		5.0	5.0			5.0	5.0	
Lane Util. Factor	1.00	0.95		1.00	0.95		1.00	1.00			1.00	1.00	
Frbp, ped/bikes	1.00	1.00		1.00	1.00		1.00	0.99			1.00	0.98	
Flpb, ped/bikes	1.00	1.00		1.00	1.00		1.00	1.00			1.00	1.00	
Frt	1.00	0.99		1.00	0.98		1.00	0.95			1.00	0.85	
Flt Protected	0.95	1.00		0.95	1.00		0.95	1.00			0.96	1.00	
Satd. Flow (prot)	1770	3502		1770	3468		1762	1763			1787	1556	
Flt Permitted	0.95	1.00		0.95	1.00		0.70	1.00			0.75	1.00	
Satd. Flow (perm)	1770	3502		1770	3468		1292	1763			1389	1556	
Peak-hour factor, PHF	0.92	0.92	0.92	0.92	0.92	0.92	0.92	0.92	0.92	0.92	0.92	0.92	
Adj. Flow (vph)	267	1420	87	32	857	109	76	27	13	72	21	276	
RTOR Reduction (vph)	0	4	0	0	11	0	0	11	0	0	0	204	
Lane Group Flow (vph)	267	1503	0	32	955	0	76	29	0	0	93	72	
Confl. Peds. (#/hr)	5		9	9		5	8		7	7		8	
Turn Type	Prot	NA		Prot	NA		Perm	NA		Perm	NA	Perm	
Protected Phases	7	4		3	8			2			6		
Permitted Phases							2			6		6	
Actuated Green, G (s)	10.1	32.2		1.8	23.9		9.5	9.5			9.5	9.5	
Effective Green, g (s)	10.1	32.2		1.8	23.9		9.5	9.5			9.5	9.5	
Actuated g/C Ratio	0.18	0.56		0.03	0.42		0.17	0.17			0.17	0.17	
Clearance Time (s)	4.0	5.0		4.0	5.0		5.0	5.0			5.0	5.0	
Vehicle Extension (s)	3.0	3.0		3.0	3.0		3.0	3.0			3.0	3.0	
Lane Grp Cap (vph)	310	1961		55	1441		213	291			229	257	
v/s Ratio Prot	c0.15	c0.43		0.02	0.28			0.02					
v/s Ratio Perm							0.06				c0.07	0.05	
v/c Ratio	0.86	0.77		0.58	0.66		0.36	0.10			0.41	0.28	
Uniform Delay, d1	23.0	9.8		27.5	13.5		21.3	20.4			21.5	21.0	
Progression Factor	1.00	1.00		1.00	1.00		1.00	1.00			1.00	1.00	
Incremental Delay, d2	20.9	1.8		14.7	1.2		1.0	0.2			1.2	0.6	
Delay (s)	44.0	11.6		42.2	14.7		22.3	20.5			22.7	21.6	
Level of Service	D	B		D	B		C	C			C	C	
Approach Delay (s)		16.5			15.6			21.7			21.9		
Approach LOS		B			B			C			C		
<b>Intersection Summary</b>													
HCM 2000 Control Delay			17.0									HCM 2000 Level of Service	B
HCM 2000 Volume to Capacity ratio			0.75										
Actuated Cycle Length (s)			57.5									Sum of lost time (s)	14.0
Intersection Capacity Utilization			68.5%									ICU Level of Service	C
Analysis Period (min)			15										
c Critical Lane Group													

















## Background + Project PM Peak Hour 2: Mission Blvd & Industrial Pkwy/Alquire Pkwy

01/21/2021

Movement	EBL	EBT	EBR	WBL	WBT	WBR	NBL	NBT	NBR	SBL	SBT	SBR	
Lane Configurations													
Traffic Volume (vph)	608	150	511	3	68	65	368	1537	17	87	1173	332	
Future Volume (vph)	608	150	511	3	68	65	368	1537	17	87	1173	332	
Ideal Flow (vphpl)	1900	1900	1900	1900	1900	1900	1900	1900	1900	1900	1900	1900	
Total Lost time (s)	4.0	4.0	4.0	4.0	4.0	4.0	4.0	4.0		4.0	4.0		
Lane Util. Factor	0.97	0.91	0.91	1.00	0.95	1.00	0.97	0.91		1.00	0.91		
Frbp, ped/bikes	1.00	1.00	1.00	1.00	1.00	0.99	1.00	1.00		1.00	0.99		
Flpb, ped/bikes	1.00	1.00	1.00	1.00	1.00	1.00	1.00	1.00		1.00	1.00		
Frt	1.00	0.91	0.85	1.00	1.00	0.85	1.00	1.00		1.00	0.97		
Flt Protected	0.95	1.00	1.00	0.95	1.00	1.00	0.95	1.00		0.95	1.00		
Satd. Flow (prot)	3433	3070	1441	1770	3539	1563	3433	5076		1770	4890		
Flt Permitted	0.95	1.00	1.00	0.95	1.00	1.00	0.95	1.00		0.95	1.00		
Satd. Flow (perm)	3433	3070	1441	1770	3539	1563	3433	5076		1770	4890		
Peak-hour factor, PHF	0.92	0.92	0.92	0.92	0.92	0.92	0.92	0.92	0.92	0.92	0.92	0.92	
Adj. Flow (vph)	661	163	555	3	74	71	400	1671	18	95	1275	361	
RTOR Reduction (vph)	0	187	186	0	0	64	0	1	0	0	35	0	
Lane Group Flow (vph)	661	254	91	3	74	7	400	1688	0	95	1601	0	
Confl. Peds. (#/hr)	1						1	15		3	3	15	
Turn Type	Prot	NA	Perm	Prot	NA	Perm	Prot	NA		Prot	NA		
Protected Phases	7	4		3	8		5	2		1	6		
Permitted Phases			4			8							
Actuated Green, G (s)	24.0	33.9	33.9	0.8	10.7	10.7	14.0	44.2		8.8	39.0		
Effective Green, g (s)	24.0	33.9	33.9	0.8	10.7	10.7	14.0	44.2		8.8	39.0		
Actuated g/C Ratio	0.23	0.33	0.33	0.01	0.10	0.10	0.14	0.43		0.08	0.38		
Clearance Time (s)	4.0	4.0	4.0	4.0	4.0	4.0	4.0	4.0		4.0	4.0		
Vehicle Extension (s)	3.0	3.0	3.0	3.0	3.0	3.0	3.0	3.0		3.0	3.0		
Lane Grp Cap (vph)	794	1003	471	13	365	161	463	2163		150	1839		
v/s Ratio Prot	c0.19	c0.08		0.00	0.02		c0.12	0.33		0.05	c0.33		
v/s Ratio Perm			0.06			0.00							
v/c Ratio	0.83	0.25	0.19	0.23	0.20	0.05	0.86	0.78		0.63	0.87		
Uniform Delay, d1	37.9	25.6	25.1	51.1	42.6	41.9	43.9	25.6		45.9	30.0		
Progression Factor	1.00	1.00	1.00	1.00	1.00	1.00	1.00	1.00		1.00	1.00		
Incremental Delay, d2	7.5	0.1	0.2	8.9	0.3	0.1	15.3	2.9		8.4	6.0		
Delay (s)	45.4	25.7	25.3	60.1	42.9	42.0	59.2	28.5		54.3	36.0		
Level of Service	D	C	C	E	D	D	E	C		D	D		
Approach Delay (s)		35.1			42.8			34.4			37.0		
Approach LOS		D			D			C			D		
<b>Intersection Summary</b>													
HCM 2000 Control Delay			35.6									HCM 2000 Level of Service	D
HCM 2000 Volume to Capacity ratio			0.79										
Actuated Cycle Length (s)			103.7									Sum of lost time (s)	16.0
Intersection Capacity Utilization			74.9%									ICU Level of Service	D
Analysis Period (min)			15										
c Critical Lane Group													























### Background + Project PM Peak Hour 3: Mission Blvd & Garin Ave

01/21/2021

						
Movement	WBL	WBR	NBT	NBR	SBL	SBT
Lane Configurations			 			   
Traffic Volume (vph)	57	79	1808	55	165	1569
Future Volume (vph)	57	79	1808	55	165	1569
Ideal Flow (vphpl)	1900	1900	1900	1900	1900	1900
Total Lost time (s)	4.0	4.0	4.0	4.0	4.0	4.0
Lane Util. Factor	1.00	1.00	0.95	1.00	1.00	0.91
Frpb, ped/bikes	1.00	0.99	1.00	1.00	1.00	1.00
Flpb, ped/bikes	1.00	1.00	1.00	1.00	1.00	1.00
Frt	1.00	0.85	1.00	0.85	1.00	1.00
Flt Protected	0.95	1.00	1.00	1.00	0.95	1.00
Satd. Flow (prot)	1770	1562	3539	1583	1770	5085
Flt Permitted	0.95	1.00	1.00	1.00	0.95	1.00
Satd. Flow (perm)	1770	1562	3539	1583	1770	5085
Peak-hour factor, PHF	0.92	0.92	0.92	0.92	0.92	0.92
Adj. Flow (vph)	62	86	1965	60	179	1705
RTOR Reduction (vph)	0	77	0	10	0	0
Lane Group Flow (vph)	62	9	1965	50	179	1705
Confl. Peds. (#/hr)		3			2	
Turn Type	Prot	Perm	NA	Perm	Prot	NA
Protected Phases	8		2		1	6
Permitted Phases		8		2		
Actuated Green, G (s)	6.2	6.2	37.4	37.4	5.0	46.4
Effective Green, g (s)	6.2	6.2	37.4	37.4	5.0	46.4
Actuated g/C Ratio	0.10	0.10	0.62	0.62	0.08	0.77
Clearance Time (s)	4.0	4.0	4.0	4.0	4.0	4.0
Vehicle Extension (s)	3.0	3.0	3.0	3.0	3.0	3.0
Lane Grp Cap (vph)	181	159	2184	976	146	3893
v/s Ratio Prot	c0.04		c0.56		c0.10	0.34
v/s Ratio Perm		0.01		0.03		
v/c Ratio	0.34	0.06	0.90	0.05	1.23	0.44
Uniform Delay, d1	25.3	24.6	10.0	4.6	27.8	2.5
Progression Factor	1.00	1.00	1.00	1.00	1.00	1.00
Incremental Delay, d2	1.1	0.1	6.5	0.1	147.7	0.4
Delay (s)	26.4	24.7	16.5	4.7	175.5	2.9
Level of Service	C	C	B	A	F	A
Approach Delay (s)	25.4		16.1			19.3
Approach LOS	C		B			B
<b>Intersection Summary</b>						
HCM 2000 Control Delay			17.9		HCM 2000 Level of Service	B
HCM 2000 Volume to Capacity ratio			0.86			
Actuated Cycle Length (s)			60.6		Sum of lost time (s)	12.0
Intersection Capacity Utilization			75.0%		ICU Level of Service	D
Analysis Period (min)			15			
c Critical Lane Group						

## Background + Project PM Peak Hour 4: Mission Blvd & Arrowhead Way

01/21/2021

													
Movement	EBL	EBT	EBR	WBL	WBT	WBR	NBL	NBT	NBR	SBL	SBT	SBR	
Lane Configurations													
Traffic Volume (vph)	12	4	38	18	12	23	87	1888	21	72	1555	26	
Future Volume (vph)	12	4	38	18	12	23	87	1888	21	72	1555	26	
Ideal Flow (vphpl)	1900	1900	1900	1900	1900	1900	1900	1900	1900	1900	1900	1900	
Total Lost time (s)	4.0	4.0		4.0	4.0		4.0	4.0		4.0	4.0		
Lane Util. Factor	1.00	1.00		1.00	1.00		1.00	0.95		1.00	0.95		
Frbp, ped/bikes	1.00	0.98		1.00	1.00		1.00	1.00		1.00	1.00		
Flpb, ped/bikes	1.00	1.00		0.99	1.00		1.00	1.00		1.00	1.00		
Frt	1.00	0.86		1.00	0.90		1.00	1.00		1.00	1.00		
Flt Protected	0.95	1.00		0.95	1.00		0.95	1.00		0.95	1.00		
Satd. Flow (prot)	1770	1581		1758	1679		1770	3532		1770	3529		
Flt Permitted	0.93	1.00		0.93	1.00		0.95	1.00		0.95	1.00		
Satd. Flow (perm)	1733	1581		1722	1679		1770	3532		1770	3529		
Peak-hour factor, PHF	0.92	0.92	0.92	0.92	0.92	0.92	0.92	0.92	0.92	0.92	0.92	0.92	
Adj. Flow (vph)	13	4	41	20	13	25	95	2052	23	78	1690	28	
RTOR Reduction (vph)	0	38	0	0	23	0	0	1	0	0	1	0	
Lane Group Flow (vph)	13	7	0	20	15	0	95	2074	0	78	1717	0	
Confl. Peds. (#/hr)			10	10			8		8	8		8	
Turn Type	Perm	NA		Perm	NA		Prot	NA		Prot	NA		
Protected Phases		4			8		5	2		1	6		
Permitted Phases	4			8									
Actuated Green, G (s)	4.3	4.3		4.3	4.3		5.0	47.8		4.0	46.8		
Effective Green, g (s)	4.3	4.3		4.3	4.3		5.0	47.8		4.0	46.8		
Actuated g/C Ratio	0.06	0.06		0.06	0.06		0.07	0.70		0.06	0.69		
Clearance Time (s)	4.0	4.0		4.0	4.0		4.0	4.0		4.0	4.0		
Vehicle Extension (s)	3.0	3.0		3.0	3.0		3.0	3.0		3.0	3.0		
Lane Grp Cap (vph)	109	99		108	106		129	2479		103	2425		
v/s Ratio Prot		0.00			0.01		c0.05	c0.59		0.04	0.49		
v/s Ratio Perm	0.01			c0.01									
v/c Ratio	0.12	0.07		0.19	0.14		0.74	0.84		0.76	0.71		
Uniform Delay, d1	30.1	30.0		30.2	30.1		30.9	7.3		31.6	6.5		
Progression Factor	1.00	1.00		1.00	1.00		1.00	1.00		1.00	1.00		
Incremental Delay, d2	0.5	0.3		0.8	0.6		19.5	3.6		26.7	1.8		
Delay (s)	30.6	30.3		31.1	30.7		50.4	10.9		58.3	8.3		
Level of Service	C	C		C	C		D	B		E	A		
Approach Delay (s)		30.4			30.9			12.6			10.4		
Approach LOS		C			C			B			B		
<b>Intersection Summary</b>													
HCM 2000 Control Delay			12.2									HCM 2000 Level of Service	B
HCM 2000 Volume to Capacity ratio			0.79										
Actuated Cycle Length (s)			68.1									Sum of lost time (s)	12.0
Intersection Capacity Utilization			79.2%									ICU Level of Service	D
Analysis Period (min)			15										
c Critical Lane Group													