



CENTRAL COUNTY COMPLETE STREETS DESIGN GUIDELINES

Final Complete Streets Design Guidelines
October 4, 2016

Central County Complete Streets Design Guidelines

Final Complete Streets Design Guidelines
October 4, 2016

Prepared by:

Kittelson and Associates, Inc.

PlaceWorks

Spokemore Consulting

Emergent Transportation Systems

With Alameda County Transportation Commission



The work upon which this publication is based was funded in whole through the Alameda County Transportation Commission (Alameda CTC) Sustainable Communities Technical Assistance Program (SC-TAP). SC-TAP is funded by One Bay Area Grant program federal funding and local Measure B funding.

Table of Contents

1. INTRODUCTION.....	1-1
2. STREET TYPE ILLUSTRATIVE SECTIONS & DESIGN CONSIDERATIONS.....	2-1
Arterial Street.....	2-3
Collector Street.....	2-4
Arterial and Collector Street Design Considerations.....	2-5
Local Street.....	2-10
Local Street Design Considerations.....	2-11
3. GLOSSARY OF DESIGN GUIDELINE DETAILS.....	3-1
Pedestrian Zone.....	3-3
Curb Zone.....	3-8
Bicycle Zone.....	3-18
Parking Zone.....	3-39
Vehicle Zone.....	3-43
Median Zone.....	3-47
Crossing Zone.....	3-50

1. INTRODUCTION

This page is intentionally blank

As jurisdictions use and reference this Complete Streets Design Guidelines document for their local projects, City engineers should also apply their technical expertise and professional judgment. Other street design documents may also be referenced as a supplement to designing complete streets projects. All complete streets projects should reflect input from the community, stakeholders, and decision makers.

INTRODUCTION

As part of the Alameda County Central County Complete Streets Implementation project (CCCS), this Complete Streets Design Guidelines document helps ensure that Central County street designs consider the full range of users on every street and accommodate these users wherever possible. The goal of these design guidelines is to help staff from the three Central County jurisdictions (San Leandro, Hayward, and Alameda County) clearly understand how to implement complete streets for each street type, for different modal priorities, and for varying contexts.

Planning Context

The Central County Complete Streets Design Guidelines seek to build on the street typology developed as part of the Alameda County Transportation Commission (Alameda CTC) Multimodal Arterial Plan (MAP). Through the MAP, Alameda CTC – in close partnership with local jurisdictions, transit operators, and other stakeholders – developed a typology that extends across the entire arterial and collector network in Alameda County.

The MAP street typology consists of three primary components: a street type overlay that classifies streets according to whether vehicular traffic is primarily regional or local serving; a land use overlay that classifies streets according to the fronting land use; and a multimodal overlay that identifies whether the street is part of a designated transit, bicycle, or truck route, or is an area of high pedestrian emphasis. Based on these three components, each arterial and collector street segment is assigned a hierarchical modal priority. Each of the five major modes (auto, transit, bike, pedestrian, and trucks) was ranked 1 through 5 for each street segment. The modal priority seeks to clarify which modes receive limited right-of-way or control parameters such as design speed. It should be noted that multiple modes may be accommodated on a street, even if the mode is not the highest priority. Depending on available right-of-way, a lower priority mode may mean that the mode receives a less dedicated facility or a more limited allocation of space, or may not be accommodated.

The MAP document is intended to provide a planning framework. It is anticipated that as the plan is implemented via project-level design development and community engagement, specific recommendations may evolve. Designers should think through the most appropriate selection of dimensions and project elements for a particular street and location, and the MAP is not intended to preclude context sensitive design.

and not conflict with the first modal priority's design considerations. For example, based on D Street's second modal priority (bicycle), the designer might opt for a wider bike lane than they would based only on the first modal priority (pedestrian).

3. Designers should consult local bicycle and pedestrian plans for local corridor street designs.
4. The final section of the document is a glossary of design guideline details to be used in the design and implementation of various complete street components.

STREET ZONE DEFINITIONS

Pedestrian Zone	The pathway on the sidewalk accessible for pedestrian travel, measured from back of sidewalk to curb zone.
Curb Zone	The area of the sidewalk that buffers the Pedestrian Zone from the roadway. It is measured from the pedestrian zone to face of the curb. This zone can contain street furnishings, landscaping, bike parking, bus stops, utilities, etc.
Bicycle Zone	The designated area on the roadway for bicycle travel and right-of-way. This zone is often delineated by striping and pavement markings.
Parking Zone	The area of the roadway designated for on-street parking. This zone is adjacent to the sidewalk to provide close access from the parked vehicle to the Pedestrian Zone.
Vehicle Zone	The area of the roadway where motorized vehicles, such as cars, buses, and trucks, travel. This zone varies in number of travel lanes depending on the street type and land use typology context.
Median Zone	The buffer on the roadway separating two vehicle zones, measured from face of the curb to face of the curb. This zone often contains landscaping and provides traffic calming on wider streets.
Shared Vehicle and Bicycle Zone	This zone is used and shared between motorized vehicles and bicycles. Bicyclists should ride closer to the adjacent curb, while drivers should yield to a bicyclist's speed or maintain an adequate distance when passing.
Crossing Zone	The area on the street that provides access for pedestrians to travel across roadways. This zone includes street intersections as well as crossing connections between opposite sidewalks.

The Central County Complete Streets Design Guidelines utilize the modal priorities and land use classifications assigned to the Central County Street Network through the MAP. These priorities are used to help a designer identify appropriate allocation of right-of-way width, relationship of street zones to each other, and selection of design elements in a logical series of steps, as discussed below.

How to Use this Document

This Complete Streets Design Guidelines document provides guidance for complete streets implementation on arterial, collector, and local streets in Central County. Figure 1 shows the structure and flow of this document. Design Considerations for arterial and collector streets are classified by highest modal priority and local streets are classified by land use typology.

Before referencing this document, the designer should first determine the highest modal priority and/or land use typology for a given corridor, using the MAP maps on Figures 2 and 3. Zoomed in maps for focus areas are provided on Figures 4, 6, 8, and 10. On these maps, every arterial and collector street located within the Central County is color coded to show its assigned first modal priority for either auto, bicycle, pedestrian, transit, or trucks. Furthermore, all lands in the Central County area are color coded by land use typology; a local corridor's land use typology is determined by its location.

1. After identifying the corridor's highest modal priority or land use typology, the designer should begin by reviewing the corridor's applicable Street Type Illustrative Section, which provides a general understanding of the intended spatial relationships of the various street components or "zones." Each Street Type Illustrative Section contains recommended zone widths based on modal priority or connections between opposite sidewalks.
2. Next, the designer should refer to the appropriate Street Type Design Consideration sheet, which provides a list of design considerations for each street zone, cross-referencing relevant design guideline details. Zones include a Pedestrian Zone, Curb Zone, Bicycle Zone, Parking Zone, Vehicle Zone, Median Zone, and Crossing Zone.

The designer should also review the design considerations for a corridor's second (see Figures 5, 7, 9, and 11) and even third modal priorities. For example, D Street (from Mission Boulevard to 1st Street) is shown as a Pedestrian Priority corridor, with the second modal priority being Bicycle Priority. This would involve referencing the second modal priority's Street Type Design Consideration sheet and choosing to incorporate any design considerations that would be allowable within the street's right-of-way

FIGURE 1 DESIGN GUIDELINES STRUCTURE ORGANIZATION

STREET TYPE ILLUSTRATIVE SECTIONS

1

The Illustrative Sections provide an overview of each street type: arterial, collector, and local. This overview includes the relevant street zones, the min./max. and recommended widths of the street zones, and typical number of vehicle lanes.

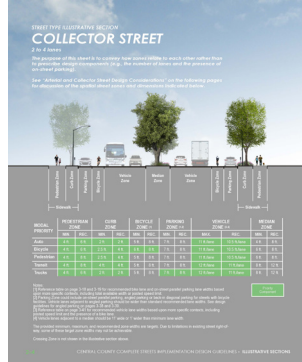
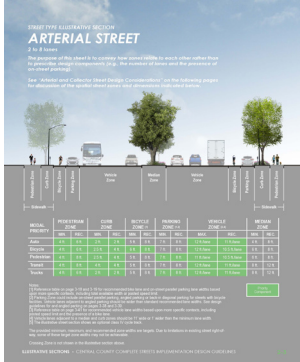

STREET TYPE DESIGN CONSIDERATIONS

2

The Design Considerations are classified by either modal priority or land use typology for each street type. They provide guidance on the types of facilities that should be considered for each street zone. Design guideline details are cross-referenced in a table at the bottom of each page.

by Modal Priority

by Land Use Typology

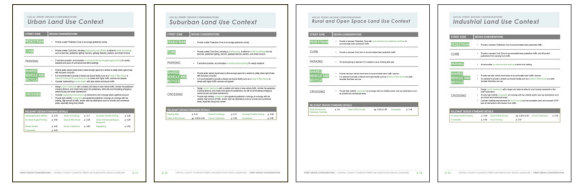
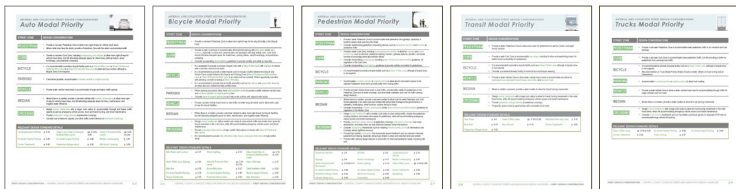

DESIGN GUIDELINE DETAILS

3

The Design Guideline Details provide detailed drawings of facilities referenced in the Design Considerations chapter. Drawings may also show variation in design depending on other factors, including land use context, street location, speed limit, and others.

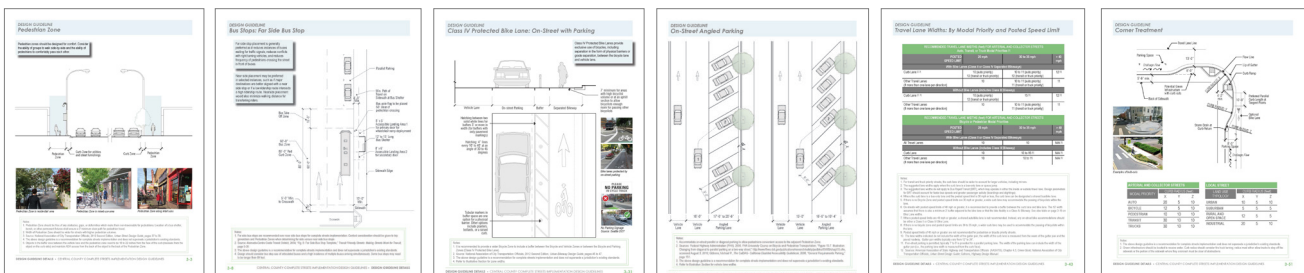

This page is intentionally blank

FIGURE 2 MULTIMODAL ARTERIAL PLAN FIRST MODAL PRIORITY AND LAND USE TYPOLOGY MAP FOR CENTRAL COUNTY

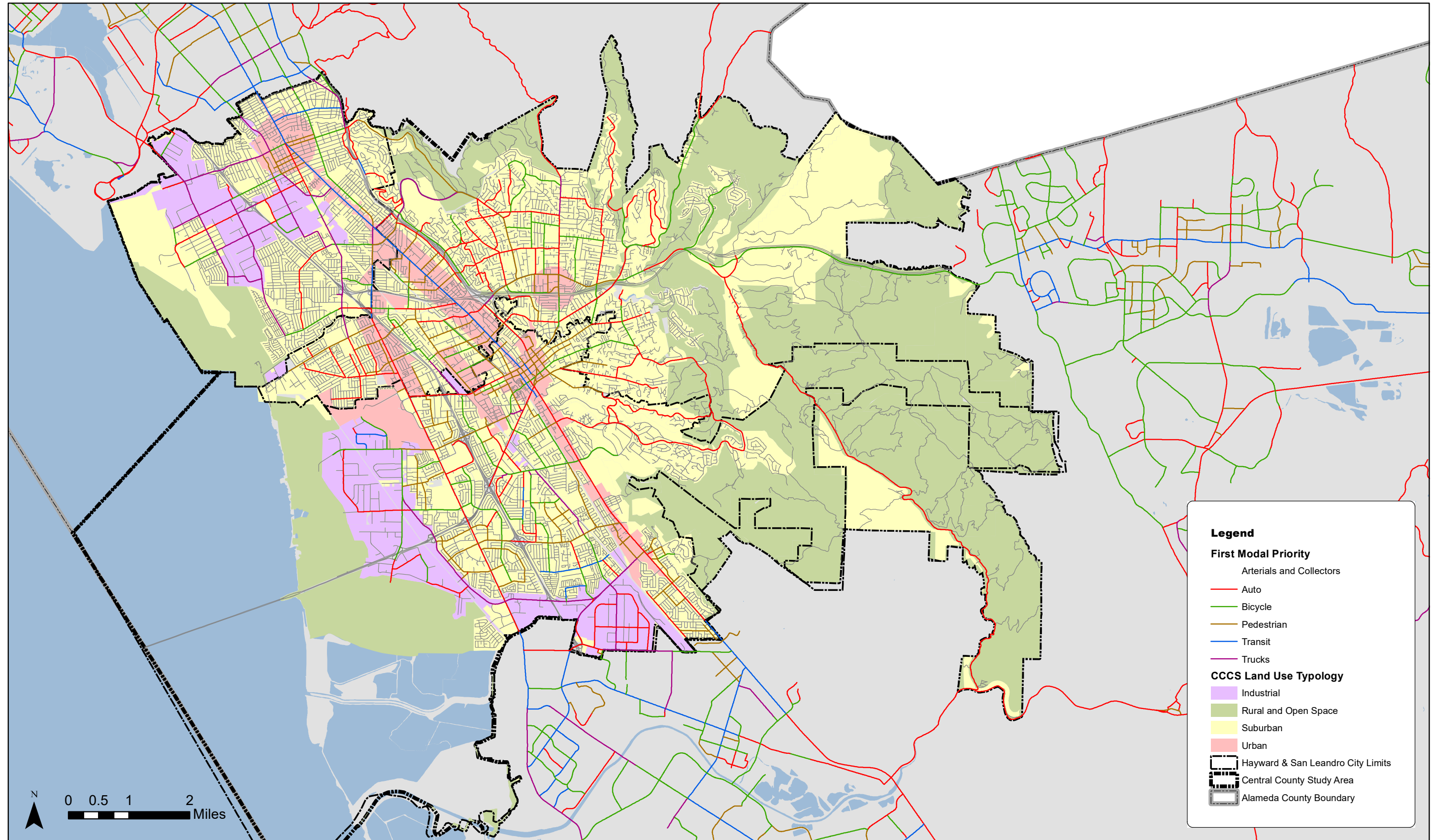

August 10, 2016

Alameda CTC Central County Complete Streets Typology

This page is intentionally blank

FIGURE 3 MULTIMODAL ARTERIAL PLAN SECOND MODAL PRIORITY AND LAND USE TYPOLOGY MAP FOR CENTRAL COUNTY

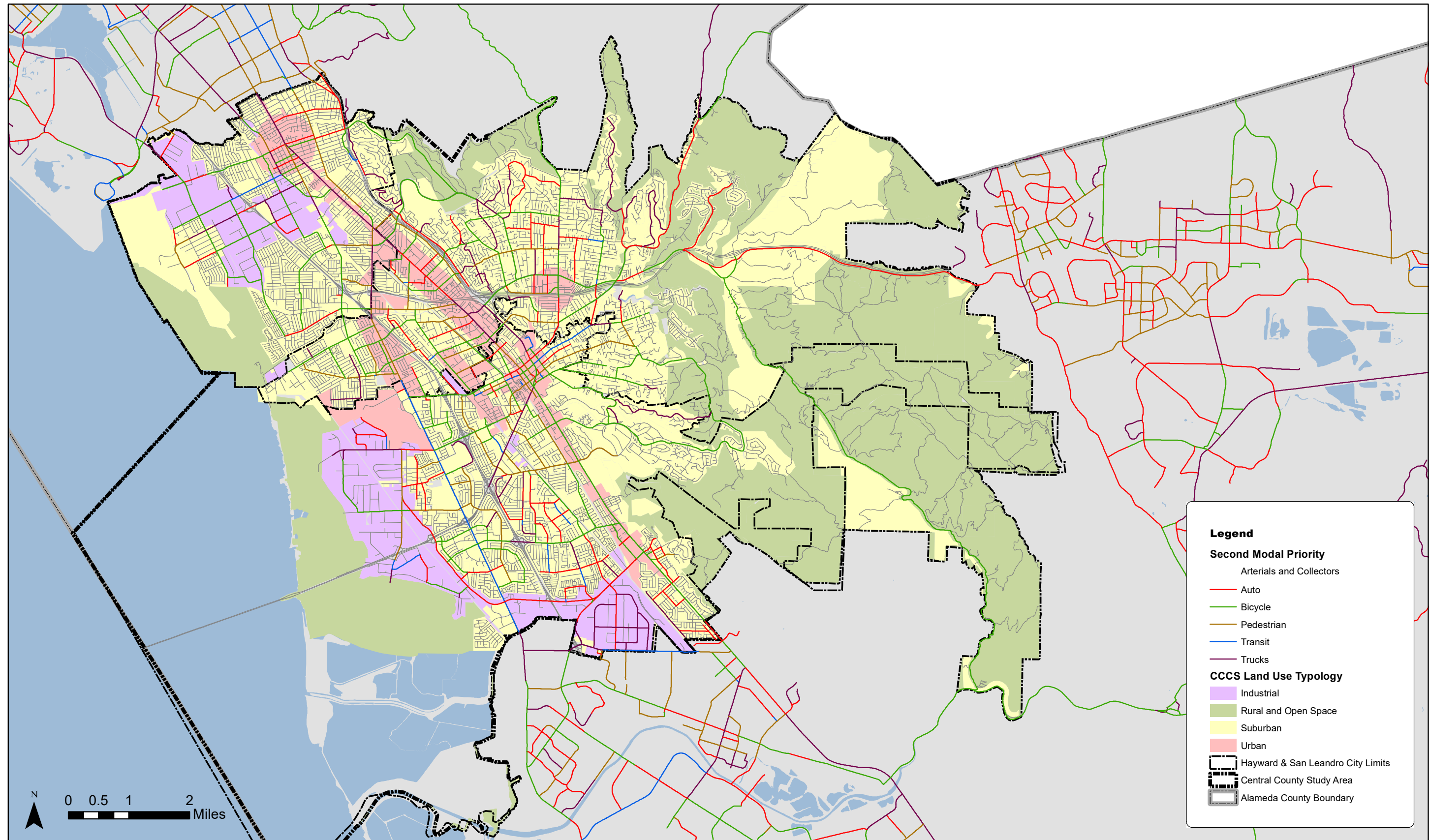

August 10, 2016

Alameda CTC Central County Complete Streets Typology

FIGURE 4 CITY OF HAYWARD: FIRST MODAL PRIORITY

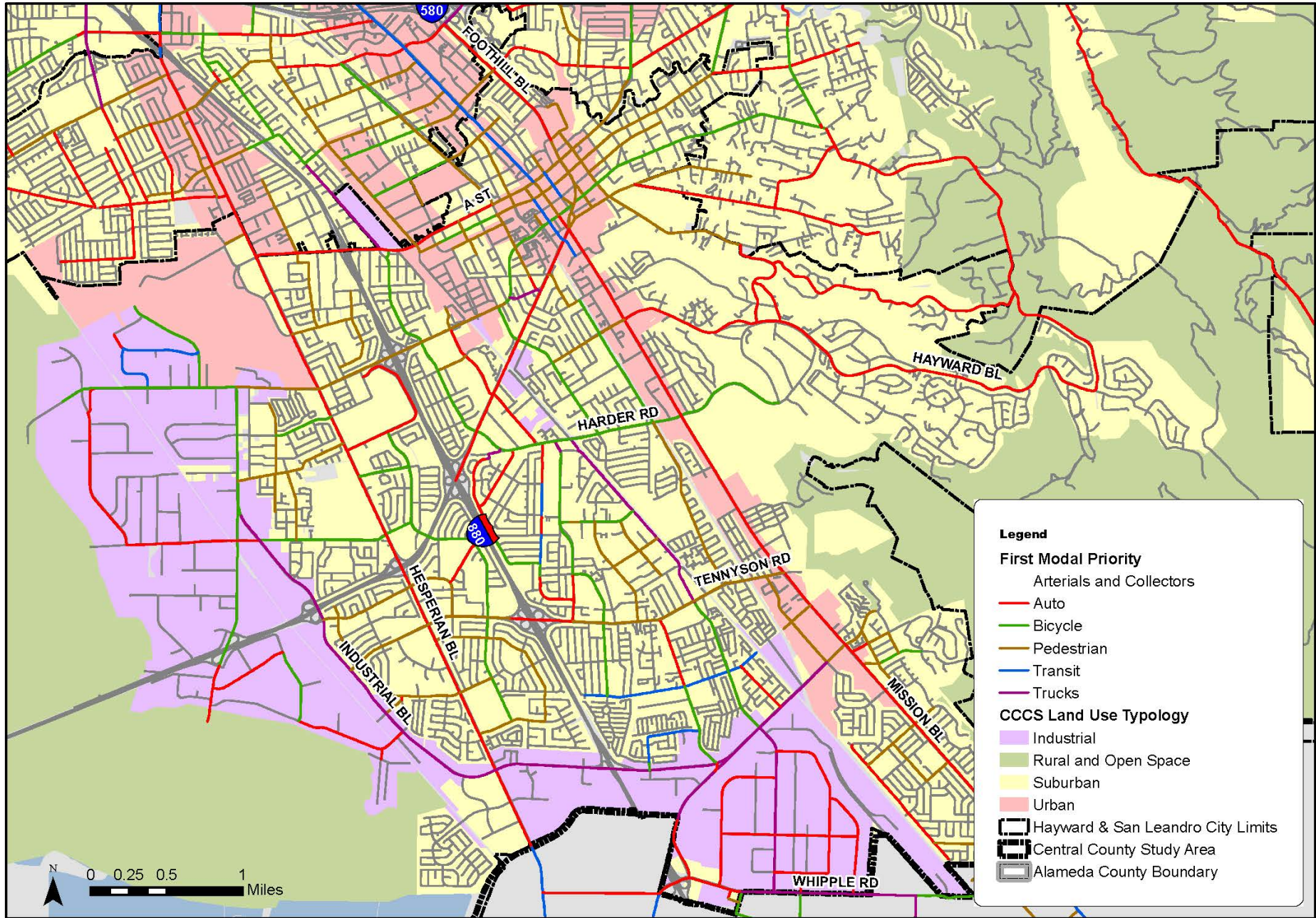

September 29, 2016

FIGURE 5 CITY OF HAYWARD: SECOND MODAL PRIORITY

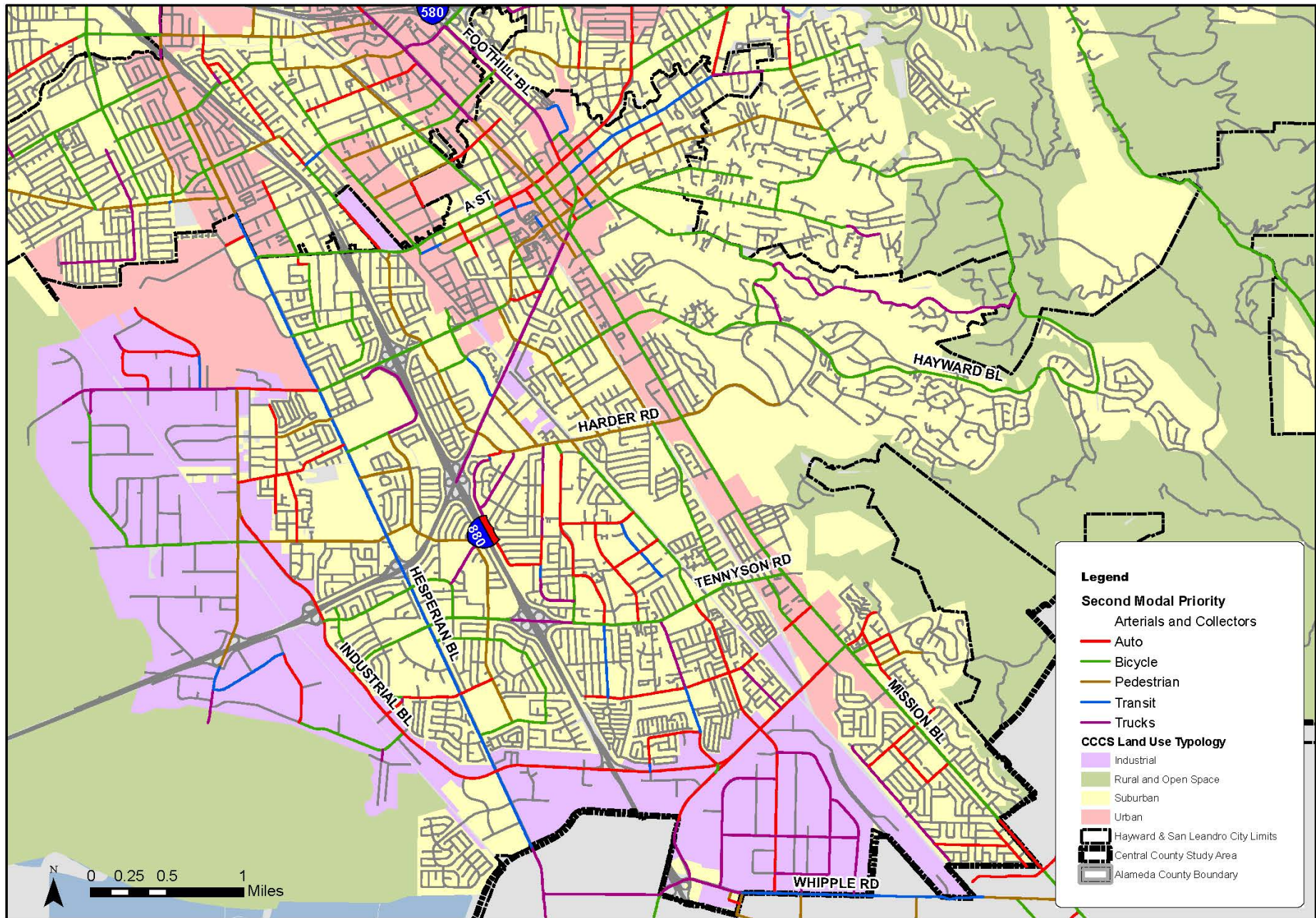

2. STREET TYPE

ILLUSTRATIVE SECTIONS & DESIGN CONSIDERATIONS

This page is intentionally blank

STREET TYPE ILLUSTRATIVE SECTION

ARTERIAL STREET

2 to 8 lanes

The purpose of this sheet is to convey how zones relate to each other rather than to prescribe design components (e.g., the number of lanes and the presence of on-street parking).

See “Arterial and Collector Street Design Considerations” on the following pages for discussion of the spatial street zones and dimensions indicated below.

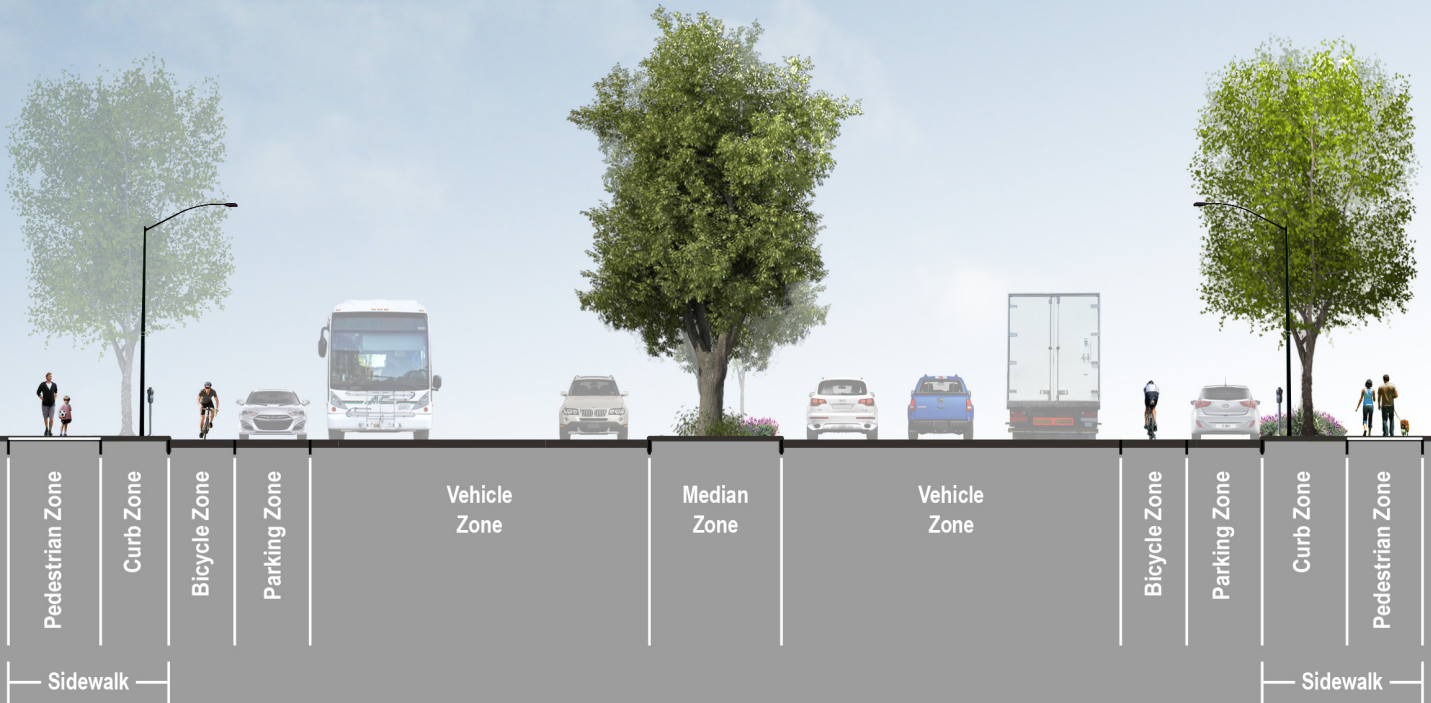

MODAL PRIORITY	PEDESTRIAN ZONE		CURB ZONE		BICYCLE ZONE [1]		PARKING ZONE [1,2]		VEHICLE ZONE [3,4]		MEDIAN ZONE	
	MIN.	REC.	MIN.	REC.	MIN.	REC.	MIN.	REC.	MAX.	REC.	MIN.	REC.
Auto	4 ft.	6 ft.	2 ft.	2 ft.	5 ft.	8 ft.	7 ft.	8 ft.	12 ft./lane	11 ft./lane	4 ft.	8 ft.
Bicycle	4 ft.	6 ft.	2.5 ft.	4 ft.	6 ft.	8 ft.	7 ft.	8 ft.	12 ft./lane	10.5 ft./lane	6 ft.	8 ft.
Pedestrian	4 ft.	8 ft.	2.5 ft.	4 ft.	5 ft.	8 ft.	7 ft.	8 ft.	11 ft./lane	10.5 ft./lane	6 ft.	8 ft.
Transit	4 ft.	8 ft.	4 ft.	4 ft.	5 ft.	8 ft.	7 ft.	8 ft.	12 ft./lane	11 ft./lane	8 ft.	12 ft.
Trucks	4 ft.	6 ft.	2 ft.	2 ft.	5 ft.	8 ft.	7 ft.	8 ft.	12 ft./lane	11 ft./lane	8 ft.	12 ft.

Notes:

- [1] Reference table on page 3-18 and 3-19 for recommended bike lane and on-street parallel parking lane widths based upon more specific contexts, including total available width or posted speed limit.
- [2] Parking Zone could include on-street parallel parking, angled parking or back-in diagonal parking for streets with bicycle facilities. Vehicle lanes adjacent to angled parking should be wider than standard recommended lane widths. See design guidelines for and angled parking on pages 3-38 and 3-39.
- [3] Reference table on page 3-41 for recommended vehicle lane widths based upon more specific contexts, including posted speed limit and the presence of a bike lane.
- [4] Vehicle lanes adjacent to a median and curb zones should be 11' wide or 1' wider than the minimum lane width.
- [5] The illustrative street section shows an optional class IV cycle track.

Priority Component

The provided minimum, maximum, and recommended zone widths are targets. Due to limitations in existing street right-of-way, some of these target zone widths may not be achievable.

Crossing Zone is not shown in the illustrative section above.

STREET TYPE ILLUSTRATIVE SECTION

COLLECTOR STREET

2 to 4 lanes

The purpose of this sheet is to convey how zones relate to each other rather than to prescribe design components (e.g., the number of lanes and the presence of on-street parking).

See “Arterial and Collector Street Design Considerations” on the following pages for discussion of the spatial street zones and dimensions indicated below.

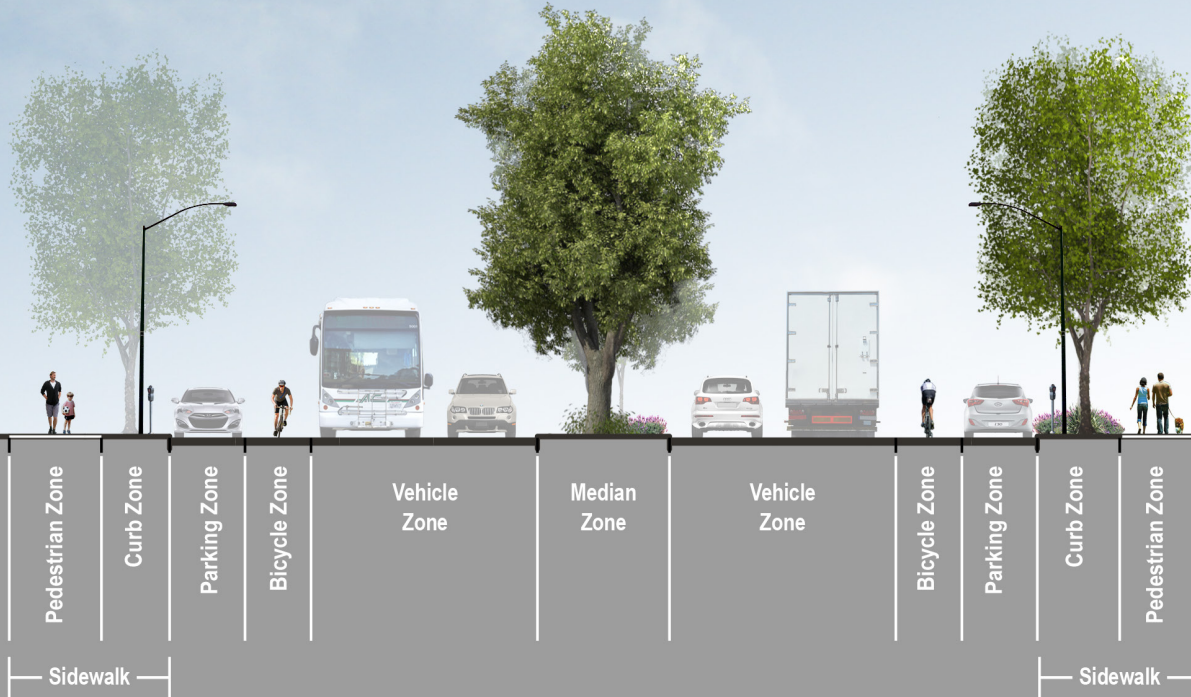

MODAL PRIORITY	PEDESTRIAN ZONE		CURB ZONE		BICYCLE ZONE ^[1]		PARKING ZONE ^[1,2]		VEHICLE ZONE ^[3,4]		MEDIAN ZONE	
	MIN.	REC.	MIN.	REC.	MIN.	REC.	MIN.	REC.	MAX.	REC.	MIN.	REC.
Auto	4 ft.	6 ft.	2 ft.	2 ft.	5 ft.	8 ft.	7 ft.	8 ft.	11 ft./lane	10.5 ft./lane	4 ft.	8 ft.
Bicycle	4 ft.	6 ft.	2.5 ft.	4 ft.	6 ft.	8 ft.	7 ft.	8 ft.	11 ft./lane	10.5 ft./lane	6 ft.	8 ft.
Pedestrian	4 ft.	8 ft.	2.5 ft.	4 ft.	5 ft.	8 ft.	7 ft.	8 ft.	11 ft./lane	10.5 ft./lane	6 ft.	8 ft.
Transit	4 ft.	8 ft.	4 ft.	4 ft.	5 ft.	8 ft.	7 ft.	8 ft.	12 ft./lane	11 ft./lane	8 ft.	12 ft.
Trucks	4 ft.	6 ft.	2 ft.	2 ft.	5 ft.	8 ft.	7 ft.	8 ft.	12 ft./lane	11 ft./lane	8 ft.	12 ft.

Notes:

- [1] Reference table on page 3-18 and 3-19 for recommended bike lane and on-street parallel parking lane widths based upon more specific contexts, including total available width or posted speed limit.
- [2] Parking Zone could include on-street parallel parking, angled parking or back-in diagonal parking for streets with bicycle facilities. Vehicle lanes adjacent to angled parking should be wider than standard recommended lane widths. See design guidelines for angled parking on pages 3-38 and 3-39.
- [3] Reference table on page 3-41 for recommended vehicle lane widths based upon more specific contexts, including posted speed limit and the presence of a bike lane.
- [4] Vehicle lanes adjacent to a median should be 11' wide or 1' wider than minimum lane width.

Priority Component

The provided minimum, maximum, and recommended zone widths are targets. Due to limitations in existing street right-of-way, some of these target zone widths may not be achievable.

Crossing Zone is not shown in the illustrative section above.

ARTERIAL AND COLLECTOR STREET DESIGN CONSIDERATIONS

Auto Modal Priority



STREET ZONE	DESIGN CONSIDERATIONS
PEDESTRIAN	<ul style="list-style-type: none"> Provide a narrower Pedestrian Zone to allow more right-of-way for vehicle travel lanes Where retail uses face the street, provide a Pedestrian Zone with the wider recommended width
CURB	<ul style="list-style-type: none"> Provide a narrower Curb Zone, including landscaping and utilities, to allow more right-of-way for vehicle travel lanes, but still allocating adequate space for street trees, parking meters, street furnishings, and pedestrian unloading
BICYCLE	<ul style="list-style-type: none"> It is recommended to provide a bicycle facility such as a Class II Bike Lane or Class II Enhanced Buffered Bike Lane, or a Class IV Protected Bike Lane in urban land use context, although a Bicycle Zone is not required
PARKING	<ul style="list-style-type: none"> If and when possible, accommodate on-street parallel or angled parking
VEHICLE	<ul style="list-style-type: none"> Provide wider vehicle travel lanes to accommodate through and higher traffic speeds
MEDIAN	<ul style="list-style-type: none"> Where there is a median, provide a narrower median with median landscaping to allow more right-of-way for vehicle travel lanes, but still allocating adequate space for trees, maintenance, and irrigation water efficiency
CROSSING	<ul style="list-style-type: none"> Design corner treatments with a larger curb radius to accommodate through and higher traffic speeds as well as emergency vehicle access, truck and transit turning, and street maintenance Provide pedestrian refuge islands at pedestrian crossings Consider use of beacons, signals, and other traffic control devices at mid-block crossings

RELEVANT DESIGN STANDARD DETAILS					
Landscaping and Utilities	p. 3-11	Class II and Class II Enhanced Buffered Bike Lanes	pp. 3-20 to 3-27	Class IV Protected Bike Lanes	pp. 3-31 to 3-35
On-street Parallel Parking	p. 3-40	On-street Angled Parking	p. 3-41	Median Landscaping	p. 3-48
Corner Treatments	p. 3-52	Pedestrian Refuge Island	p. 3-49	Mid-block Crossing	p. 3-55

Bicycle Modal Priority



STREET ZONE	DESIGN CONSIDERATIONS
PEDESTRIAN	<ul style="list-style-type: none"> Provide a narrower Pedestrian Zone to allow more right-of-way for the bicycle facility in the Bicycle Zone
CURB	<ul style="list-style-type: none"> Provide a wider Curb Zone to accommodate off-street bike parking with bike racks and/or bike lockers, especially in urban and suburban land use typologies with high activity uses. Curb Zone should still allow adequate space for street trees, parking meters, street furnishings, and pedestrian unloading. Consider incorporating street lighting guidelines to provide visibility and safety for bicyclists
BICYCLE	<ul style="list-style-type: none"> It is acceptable to provide a narrower Bicycle Zone with a Class II Bike Lane with signage on streets with a narrower overall street width It is recommended to provide a wider Bicycle Zone to include a buffer between the Bicycle and Vehicle Zones and/or between the Bicycle and Parking Zones (Class II Enhanced Buffered Bike Lane or Class IV Protected Bike Lane in an urban land use context). Where opportunity coincides with planning, consider providing a Class I Bikeway. It is recommended to provide bicycle facility amenities such as bike boxes and green bike lanes in an urban land use context and high conflict areas
PARKING	<ul style="list-style-type: none"> Where parking is provided, allow more total available width to provide a buffer between the bike lane and on-street parallel or angled parking lane Consider back-in angled parking to also help avoid conflicts with adjacent bike facility
VEHICLE	<ul style="list-style-type: none"> Provide narrower vehicle travel lanes to slow traffic for better bicyclist safety and to allow wider right-of-way for bicycle facilities
MEDIAN	<ul style="list-style-type: none"> Where there is a median, provide a narrower median to allow more right-of-way for bicycle facilities, but still allocating adequate space for trees, maintenance, and irrigation water efficiency
CROSSING	<ul style="list-style-type: none"> Design corner treatments with a smaller curb radius to slow vehicle traffic and create more space for bicycle amenities in the Curb Zone, while still accommodating emergency vehicle access and street maintenance Provide protected intersections at high-conflict intersections of streets with Class IV Protected Bike Lanes It is recommended to provide bike detection, bike boxes, and green bike lanes in high conflict areas

RELEVANT DESIGN STANDARD DETAILS

Bike Racks and Lockers	p. 3-38	Street Lighting	p. 3-13	Class II and Class II Enhanced Buffered Bike Lanes	pp. 3-20 to 3-27
Class II Bike Lane Signage	p. 3-23	Class IV Protected Bike Lanes	pp. 3-31 to 3-35	Class I Bikeway	p. 3-19
Bike Box	p. 3-36	Green Bike Lane	p. 3-28	Total Available Width	p. 3-21
On-street Parallel Parking	p. 3-40	On-street Angled Parking	p. 3-41	Back-in Angled Parking	p. 3-42
Corner Treatments	p. 3-52	Protected Intersection	p. 3-53	Bike Detection	p. 3-37

Pedestrian Modal Priority



STREET ZONE	DESIGN CONSIDERATIONS
PEDESTRIAN	<ul style="list-style-type: none"> Provide a wider Pedestrian Zone to accommodate wide pedestrian throughways, especially in locations where retail uses face the street Consider implementing pedestrian channeling devices such as pedestrian barriers and dividers for pedestrian traffic
CURB	<ul style="list-style-type: none"> Provide a wider Curb Zone, including landscaping and utilities, to allow for signage and street furnishings such as benches, pedestrian lighting, banners, gateway features, planters, and street furniture to encourage active ground floor activity Consider incorporating landscaping, including green infrastructure/stormwater guidelines, for vegetation in the Curb Zone Consider incorporating street lighting guidelines to provide visibility and safety for pedestrians
BICYCLE	<ul style="list-style-type: none"> It is recommended to provide a bicycle facility such as a Class II Bike Lane, although a bicycle zone is not required
PARKING	<ul style="list-style-type: none"> Accommodate on-street parallel or angled parking to allow drivers convenient access to the adjacent Pedestrian Zone and to provide buffer from moving traffic
VEHICLE	<ul style="list-style-type: none"> Provide narrower vehicle travel lanes to slow traffic, provide better safety for pedestrians in the Pedestrian Zone and at street crossings, and allow wider sidewalks and room for traffic calming design features
MEDIAN	<ul style="list-style-type: none"> Where there is a median, provide a narrower median to allow room for wide Pedestrian and Curb Zones especially in an urban land use context with active retail frontage at the ground level (i.e. sidewalks, landscaping, street furniture, outdoor dining furniture) Consider incorporating median landscaping and/or green infrastructure/stormwater guidelines for vegetation in the Median Zone
CROSSING	<ul style="list-style-type: none"> Design corner treatments with a smaller curb radius to slow vehicle traffic, shorten the pedestrian crossing distance, and create more space for pedestrians, while still accommodating emergency vehicle access and street maintenance Provide pedestrian refuge islands at pedestrian crossings, mid-block crossings near major destinations, and where there are long distances between street intersections Consider daylighting intersections such as installing Painted Safety Zones at intersections and crossings where sightlines are poor Provide high visibility crosswalks that incorporate special treatment such as colored or textured pavement and striping, especially along busy streets in urban and suburban land use context Provide traffic calming design features to slow traffic for improved pedestrian safety, including bulb-outs

RELEVANT DESIGN STANDARD DETAILS

Pedestrian Barriers	p. 3-5	Dividers	p. 3-6	Landscaping and Utilities	p. 3-11
Signage	p. 3-10	Street Furnishings	p. 3-12	Median Landscaping	p. 3-48
Green Infrastructure/Stormwater	p. 3-14 to 3-15	Street Lighting	p. 3-13	Class II Bike Lanes	pp. 3-20 to 3-27
On-street Parallel Parking	p. 3-40	On-street Angled Parking	p. 3-41	Corner Treatments	p. 3-52
Pedestrian Refuge Island	p. 3-49	Mid-block Crossing	p. 3-55	Daylighting	p. 3-56
Painted Safety Zone	p. 3-57	Crosswalks	p. 3-51		

Transit Modal Priority



STREET ZONE	DESIGN CONSIDERATIONS
PEDESTRIAN	<ul style="list-style-type: none"> Provide a wider Pedestrian Zone to allow more room for pedestrians to wait for, board, and alight transit vehicles
CURB	<ul style="list-style-type: none"> Provide a wide Curb Zone to accommodate bus stops, including furniture and wayfinding kiosks for better transit accessibility for pedestrians
BICYCLE	<ul style="list-style-type: none"> It is recommended to provide a bicycle facility such as a Class II Bike Lane, although a bicycle zone is not required Consider a protected bikeway facility to minimize bus and bicycle weaving
VEHICLE	<ul style="list-style-type: none"> Provide a wider Vehicle Zone to allow wider outside travel lanes to accommodate and allow for dedicated bus-only/rapid transit lanes, bus bulbs, and bus pull outs
MEDIAN	<ul style="list-style-type: none"> Where a median is present, provide a wider median to allow for transit turning movements
CROSSING	<ul style="list-style-type: none"> Design corner treatments with a large curb radius to allow for transit turning movements in the outer travel lanes, while still accommodating emergency vehicle access and street maintenance Provide pedestrian refuge islands at pedestrian crossings Frequently space crossing opportunities with crosswalks at all stops

RELEVANT DESIGN STANDARD DETAILS

Bus Stops	p. 3-9	Class II Bike Lanes	pp. 3-20 to 3-27	Dedicated Bus-only Lane	p. 3-45
Bus Bulb	p. 3-17	Bus Pull-out	p. 3-16	Corner Treatments	p. 3-52
Pedestrian Refuge Island	p. 3-49				

Trucks Modal Priority



STREET ZONE	DESIGN CONSIDERATIONS
PEDESTRIAN	<ul style="list-style-type: none"> Provide a narrower Pedestrian Zone to accommodate lower pedestrian traffic in an industrial land use typology
CURB	<ul style="list-style-type: none"> Provide a narrower Curb Zone to accommodate lower pedestrian traffic, but still providing a buffer for pedestrians from passing truck traffic
BICYCLE	<ul style="list-style-type: none"> It is recommended to provide a bicycle facility such as a Class II Bike Lane, although a bicycle zone is not required Bike lane facilities on Truck Modal Priority Streets should consider effects on truck turning radii at intersections
PARKING	<ul style="list-style-type: none"> Accommodate on-street parallel or angled parking to allow truck loading
VEHICLE	<ul style="list-style-type: none"> Provide a wider Vehicle Zone to allow a wider outside travel lane for accommodating through traffic for larger vehicles such as trucks
MEDIAN	<ul style="list-style-type: none"> Where there is a median, provide a wider median to allow for truck turning movements
CROSSING	<ul style="list-style-type: none"> Design corner treatments with a large curb radius to allow for truck turning movements in the outer travel lanes, while still accommodating emergency vehicle access and street maintenance Consider truck turning treatments such as mountable curbs/truck aprons or recessed STOP bars to accommodate large vehicle off-tracking

RELEVANT DESIGN STANDARD DETAILS			
Class II Bike Lanes	pp. 3-20 to 3-27	On-street Parallel Parking	p. 3-40 On-street Angled Parking p. 3-41
Corner Treatments	p. 3-52	Truck Turning	p. 3-58

STREET TYPE ILLUSTRATIVE SECTION

LOCAL STREET

2 lanes

The purpose of this sheet is to convey how zones relate to each other rather than to prescribe design components (e.g., the number of lanes and the presence of on-street parking).

See “Local Street Design Considerations” on the following pages for discussion of the spatial street zones and dimensions indicated below.

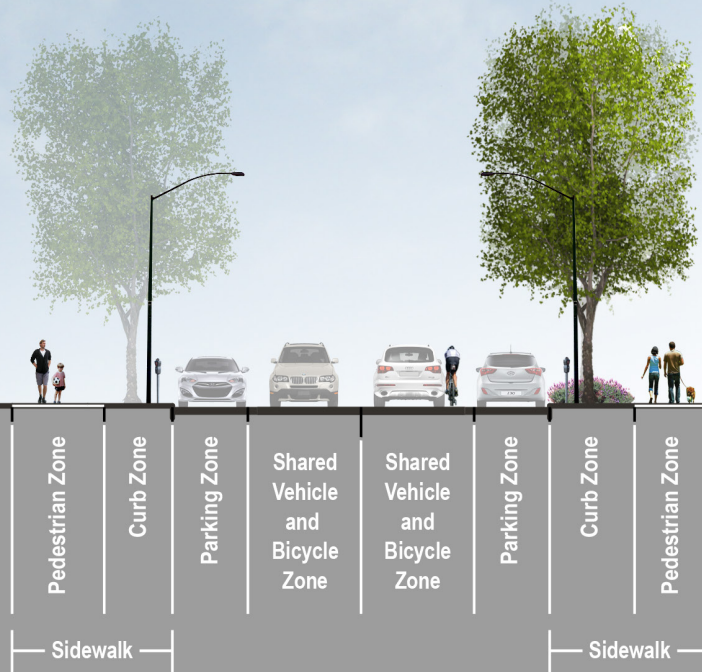

LAND USE TYPOLOGY	PEDESTRIAN ZONE		CURB ZONE		PARKING ZONE ^[1]		SHARED VEHICLE AND BICYCLE ZONE ^[2]	
	MIN.	REC.	MIN.	REC.	MIN.	REC.	MIN.	REC.
Urban	5 ft.	8 ft.	2.5 ft.	4 ft.	7.5 ft.	8 ft.	10.5 ft./lane	11 ft./lane
Suburban	5 ft.	6 ft.	2.5 ft.	4 ft.	7.5 ft.	8 ft.	10.5 ft./lane	12 ft./lane
Rural and Open Space	4 ft.	6 ft.	0 ft.	2 ft.	7.5 ft.	8 ft.	10.5 ft./lane	12 ft./lane
Industrial	4 ft.	6 ft.	0 ft.	2 ft.	7.5 ft.	8 ft.	11 ft./lane	14 ft./lane

Notes:

[1] Parking Zone could include on-street angled parking or back-in diagonal parking for streets with bicycle facilities. Design guidelines for angled parking can be found on pages 3-38 and 3-39.

[2] Vehicles could also include buses and trucks.

The provided minimum, maximum, and recommended zone widths are targets. Due to limitations in existing street right-of-way, some of these target zone widths may not be achievable.

Crossing Zone is not shown in the illustrative section above.

Priority Component

LOCAL STREET DESIGN CONSIDERATIONS

Urban Land Use Context

STREET ZONE	DESIGN CONSIDERATIONS
PEDESTRIAN	<ul style="list-style-type: none"> Provide a wider Pedestrian Zone to encourage pedestrian activity
CURB	<ul style="list-style-type: none"> Provide a wider Curb Zone, including landscaping and utilities, to allow for street furnishings such as benches, pedestrian lighting, banners, gateway features, planters, and street furniture
PARKING	<ul style="list-style-type: none"> If and when possible, accommodate on-street parallel parking or angled parking for nearby residents and users of commercial and office buildings
SHARED VEHICLE AND BICYCLE	<ul style="list-style-type: none"> Provide wider vehicle travel lanes to allow enough space for a vehicle to safely share right-of-way with and pass a bicyclist It is recommended to provide a shared use bicycle facility such as a Class III Bike Route or Class III Enhanced Bicycle Boulevard on streets with higher traffic volumes and speeds Consider implementing shared streets with slow vehicle and bicycle traffic
CROSSING	<ul style="list-style-type: none"> Design corner treatments with a smaller curb radius to slow vehicle traffic, shorten the pedestrian crossing distance, and create more space for pedestrians, while still accommodating emergency vehicle access and street maintenance Consider daylighting intersections at intersections and crossings where sightlines are poor Provide high visibility crosswalks and signalized pedestrian crossings at crossings with low visibility, high amount of traffic, and/or near key destinations such as schools and commercial areas, especially along busy streets

RELEVANT DESIGN STANDARD DETAILS					
Landscaping and Utilities	p. 3-11	Street Furnishings	p. 3-12	On-street Parallel Parking	p. 3-40
On-street Angled Parking	p. 3-41	Class III Bike Route	p. 3-29	Class III Enhanced Bicycle Boulevard	p. 3-30
Shared Street	p. 3-46	Corner Treatments	p. 3-52	Daylighting	p. 3-56
Crosswalks	p. 3-51				

LOCAL STREET DESIGN CONSIDERATIONS

Suburban Land Use Context

STREET ZONE	DESIGN CONSIDERATIONS
PEDESTRIAN	<ul style="list-style-type: none"> Provide a wider Pedestrian Zone to encourage pedestrian activity
CURB	<ul style="list-style-type: none"> Provide a wider Curb Zone, including a planting strip, to allow for street furnishings such as benches, pedestrian lighting, banners, gateway features, planters, and street furniture
PARKING	<ul style="list-style-type: none"> If and when possible, accommodate on-street parallel parking for nearby residents
SHARED VEHICLE AND BICYCLE	<ul style="list-style-type: none"> Provide wider vehicle travel lanes to allow enough space for a vehicle to safely share right-of-way with and pass a bicyclist It is recommended to provide a shared use bicycle facility such as a Class III Bike Route on streets with higher traffic volumes and speeds
CROSSING	<ul style="list-style-type: none"> Design corner treatments with a smaller curb radius to slow vehicle traffic, shorten the pedestrian crossing distance, and create more space for pedestrians, but still accommodating emergency vehicle access and street maintenance Provide high visibility crosswalks and signalized pedestrian crossings at crossings with low visibility, high amount of traffic, and/or near key destinations such as schools and commercial areas, especially along busy streets

RELEVANT DESIGN STANDARD DETAILS

Planting Strip	p. 3-11	Street Furnishings	p. 3-12	On-street Parallel Parking	p. 3-40
Class III Bike Routes	pp. 3-29 to 3-30	Corner Treatments	p. 3-52	Crosswalks	p. 3-51

LOCAL STREET DESIGN CONSIDERATIONS

Rural and Open Space Land Use Context

STREET ZONE	DESIGN CONSIDERATIONS
PEDESTRIAN	<ul style="list-style-type: none"> Provide a narrower Pedestrian Zone with rural solutions for pedestrian facilities to accommodate lower pedestrian traffic
CURB	<ul style="list-style-type: none"> Provide a narrower Curb Zone to accommodate lower pedestrian traffic
PARKING	<ul style="list-style-type: none"> On-street parking is optional if it is needed to serve fronting land uses
SHARED VEHICLE AND BICYCLE	<ul style="list-style-type: none"> Provide narrower vehicle travel lanes to accommodate lower traffic volumes It is optional to provide a shared use bicycle facility such as a Class III Bike Route or a wide shoulder that bikes can use
CROSSING	<ul style="list-style-type: none"> Provide high visibility crosswalks at crossings with low visibility and/or near key destinations such as schools and commercial areas

RELEVANT DESIGN STANDARD DETAILS					
Rural Solutions for Pedestrian Facilities	p. 3-7	Class III Bike Routes	pp. 3-29 to 3-30	Crosswalks	p. 3-51

LOCAL STREET DESIGN CONSIDERATIONS

Industrial Land Use Context

STREET ZONE	DESIGN CONSIDERATIONS
PEDESTRIAN	<ul style="list-style-type: none"> Provide a narrower Pedestrian Zone to accommodate lower pedestrian traffic
CURB	<ul style="list-style-type: none"> Provide a narrower Curb Zone to accommodate lower pedestrian traffic, but still protect pedestrians from passing truck traffic
PARKING	<ul style="list-style-type: none"> Accommodate on-street parallel parking to allow truck loading
SHARED VEHICLE AND BICYCLE	<ul style="list-style-type: none"> Provide narrower vehicle travel lanes to accommodate lower traffic volumes It is optional to provide a shared use bicycle facility such as a Class III Bike Route or a wide shoulder that bikes can use
CROSSING	<ul style="list-style-type: none"> Design corner treatments with a large curb radius to allow for truck turning movements in the outer travel lanes Provide high visibility crosswalks at crossings with low visibility and/or near key destinations such as schools and commercial areas Consider installing improvements for truck turning such as mountable curbs and recessed STOP bars at intersections with heavier truck traffic

RELEVANT DESIGN STANDARD DETAILS

On-street Parallel Parking	p. 3-40	Class III Bike Routes	pp. 3-29 to 3-30	Corner Treatments p. 3-52
Crosswalks	p. 3-51	Truck Turning	p. 3-58	

3. GLOSSARY OF DESIGN GUIDELINE DETAILS

This page is intentionally blank

PEDESTRIAN ZONE



DESIGN GUIDELINE
Pedestrian Zone

Pedestrian zones should be designed for comfort. Consider the ability of groups to walk side-by-side and the ability of pedestrians to comfortably pass each other.

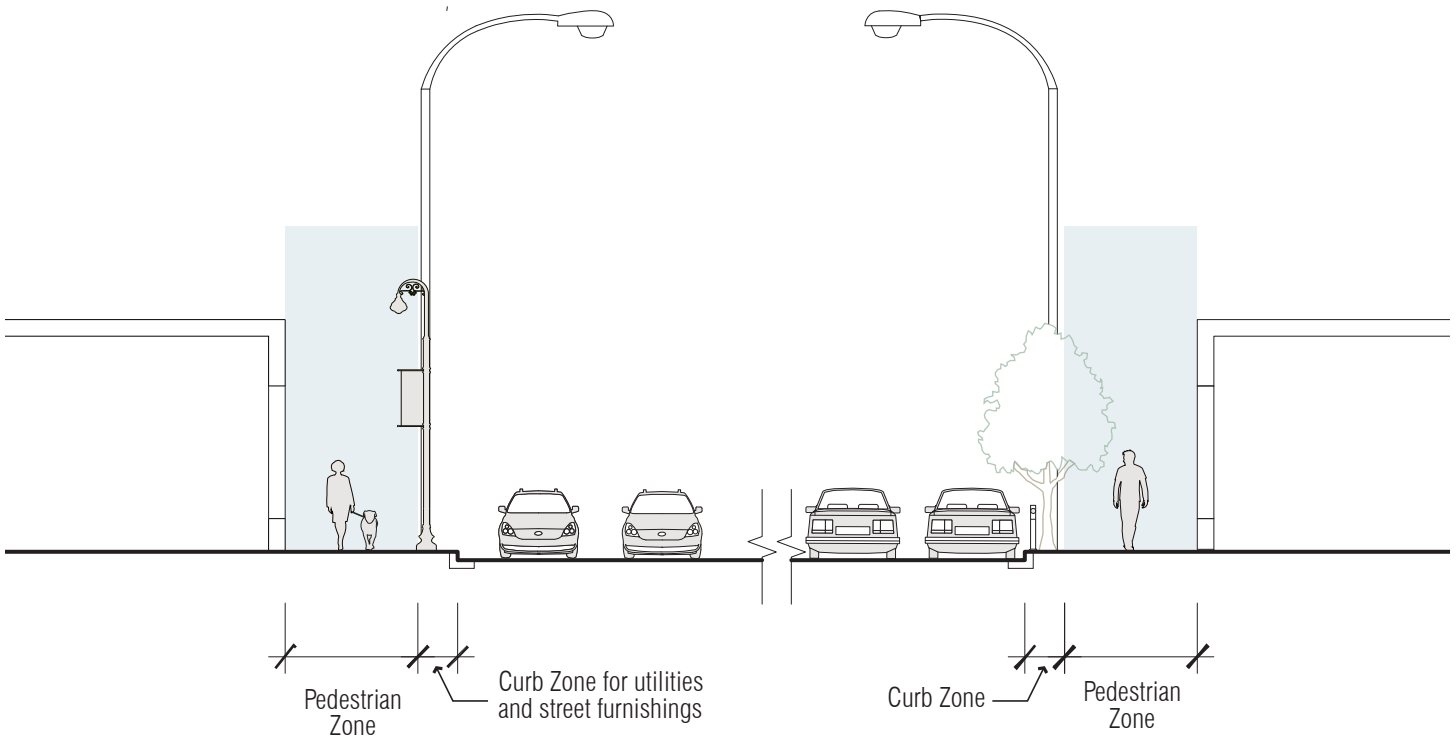

Pedestrian Zone in residential area



Pedestrian Zone in mixed-use area



Pedestrian Zone along retail uses

Notes:

1. Pedestrian Zone should be free of any obstacles, gaps, or deformities which make them non-traversable for pedestrians. Location of a bus shelter, bench, or other permanent fixtures shall ensure a 3' minimum clear path for pedestrian travel.
2. Width of Pedestrian Zone should be wider for streets with higher pedestrian volumes.
3. Source: National Association of City Transportation Officials, 2012 Second Edition, *Urban Street Design Guide*, pages 37 to 39.
4. The above design guideline is a recommendation for complete streets implementation and does not supersede a jurisdiction's existing standards.
5. Objects in the buffer area between the vehicle lane and the pedestrian zone need to be 18 to 22 inches from the face of the curb (measure from the object on the curb side) and maintain ADA access from the back of the object to the back of the Pedestrian Zone.

DESIGN GUIDELINE

Pedestrian Channeling Devices: Pedestrian Barriers

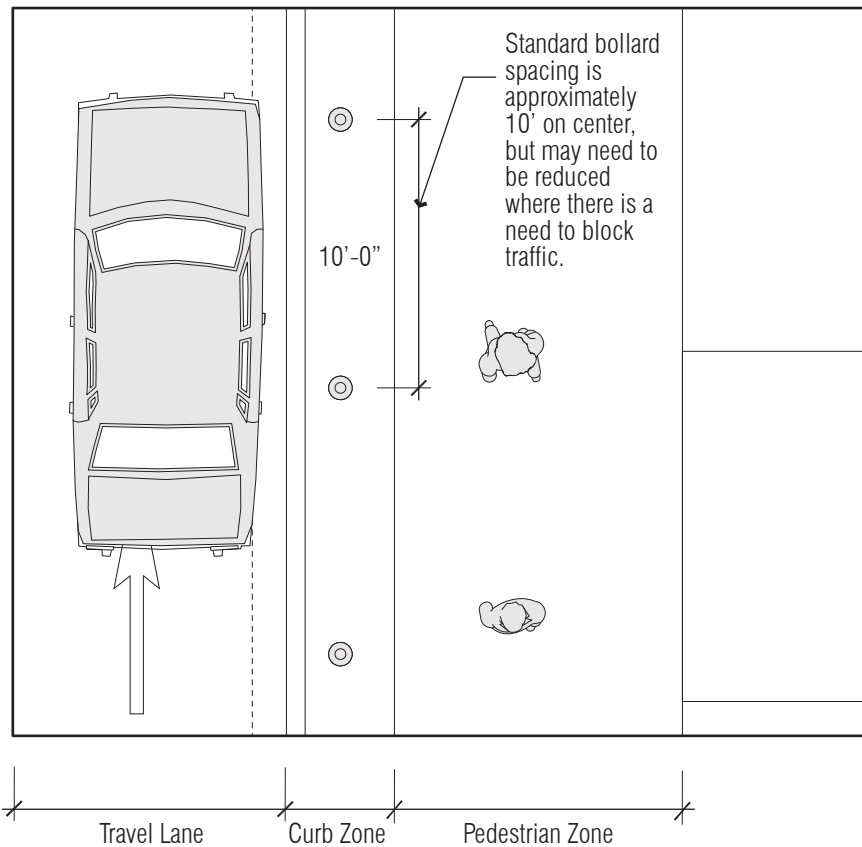
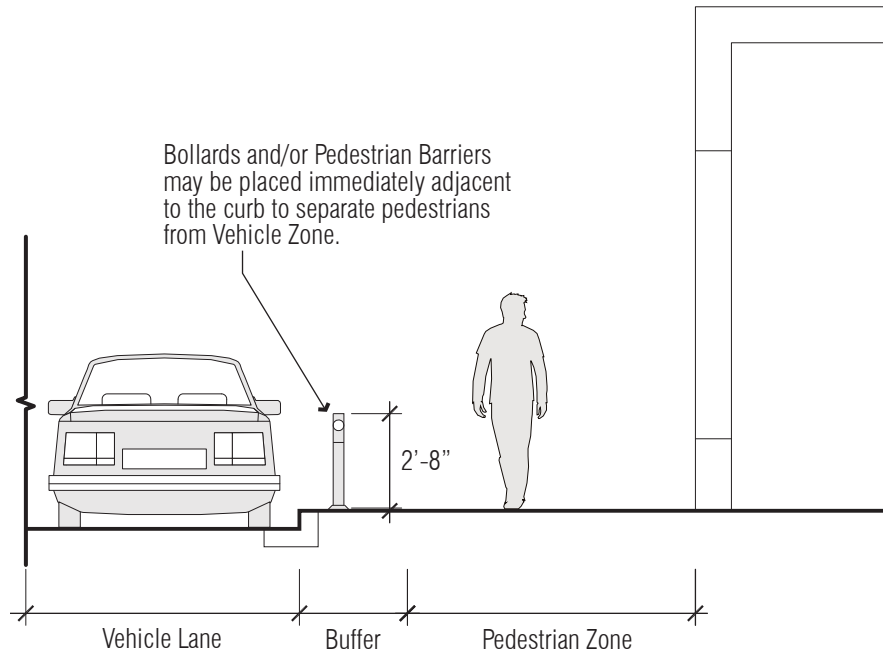

Notes:

1. Consider implementing pedestrian channeling devices for pedestrian traffic when adjacent to high-speed vehicle lanes and where there is no Parking Zone.
2. Bollards are typically 4" to 10" in diameter and should be painted in colors other than grey to be easily visible. Decorative bollards may vary in form and size.
3. Source: City and County of San Francisco, 2011, Chapter 6: Streetscape Elements, *Better Streets Plan*, page 222.
4. The above design guideline is a recommendation for complete streets implementation and does not supersede a jurisdiction's existing standards.

DESIGN GUIDELINE

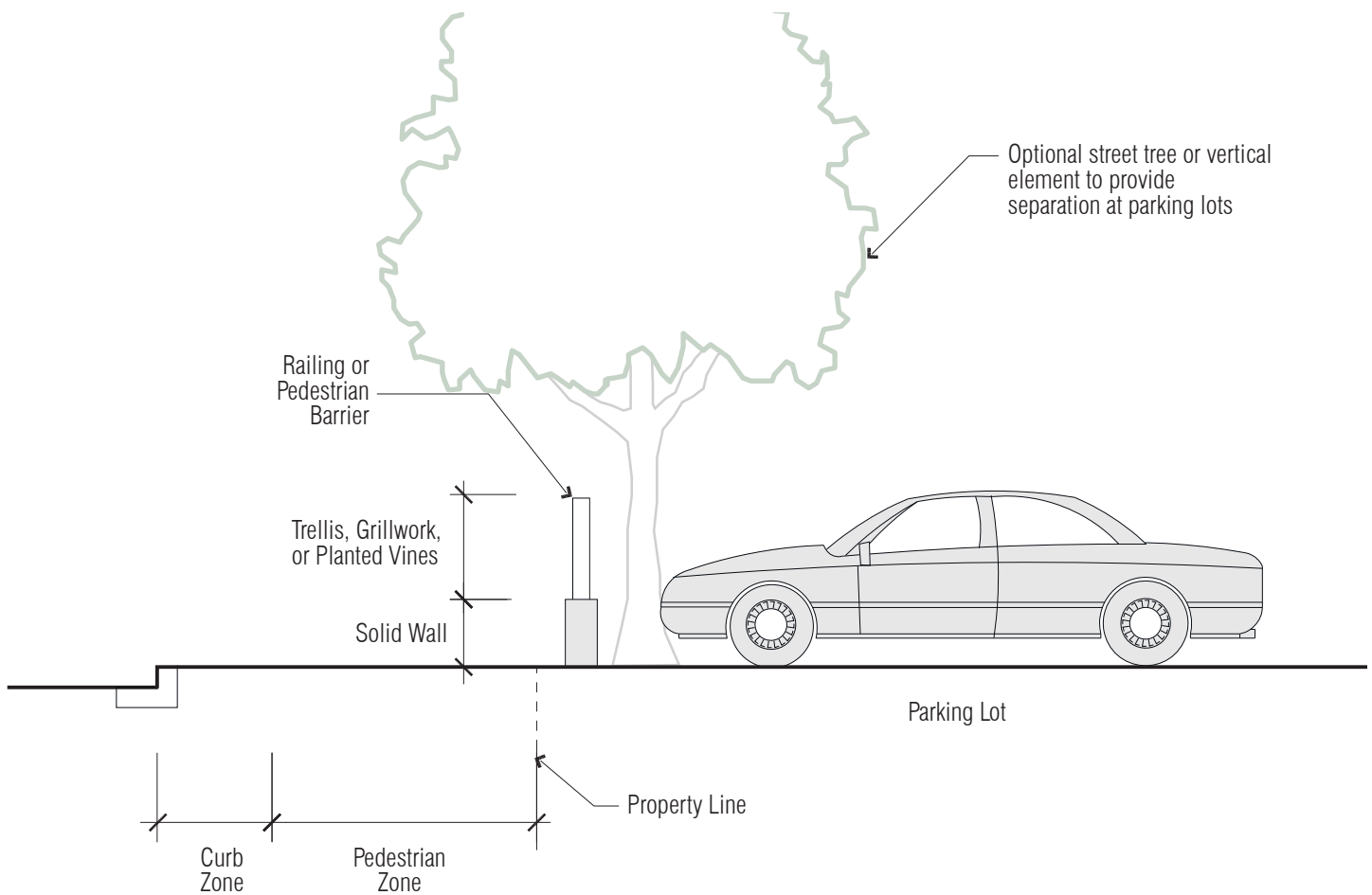
Pedestrian Channeling Devices: Dividers at Surface Parking Lots

Notes:

1. Recommended for sidewalks adjacent to surface parking to provide visual separation and to focus physical access to and from parking areas.
2. Railings should be a minimum of 2'-6" to 3'-6" in height and minimum of 70 percent open to limit non-visible areas for safety. Solid walls can be 1'-6" to 2'-8" in height.
3. The above design guideline is a recommendation for complete streets implementation and does not supersede a jurisdiction's existing standards.
4. Zoning regulations should be considered in development of any barriers or fencing for property and sidewalks.

DESIGN GUIDELINE
Rural Solutions for Pedestrian Facilities

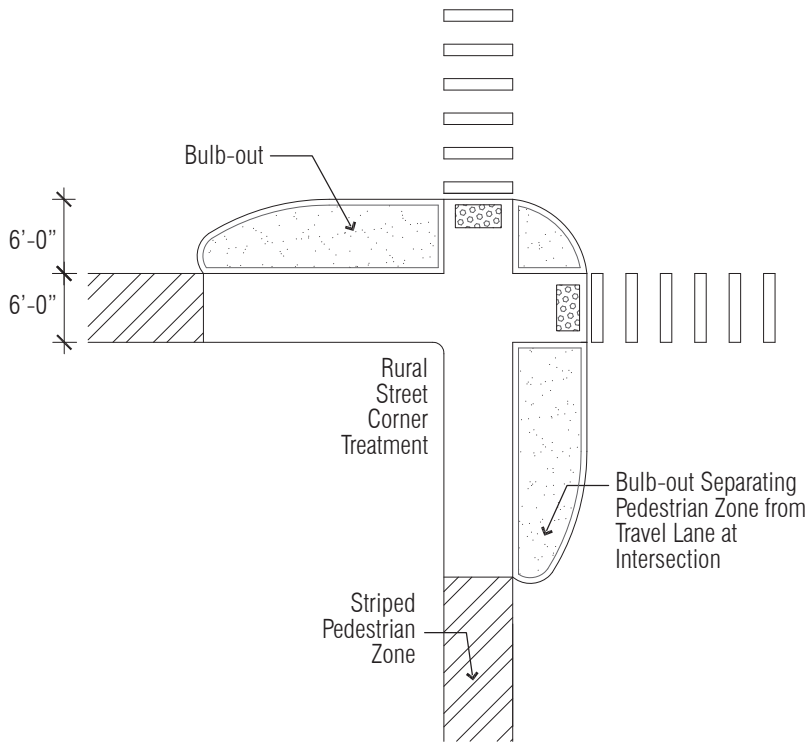

RURAL STREET CORNER TREATMENT

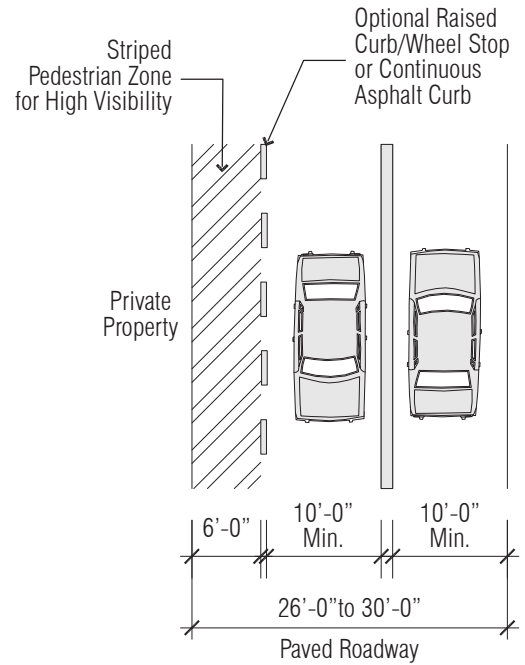

RURAL STREET PLAN SHOWING PEDESTRIAN FACILITY

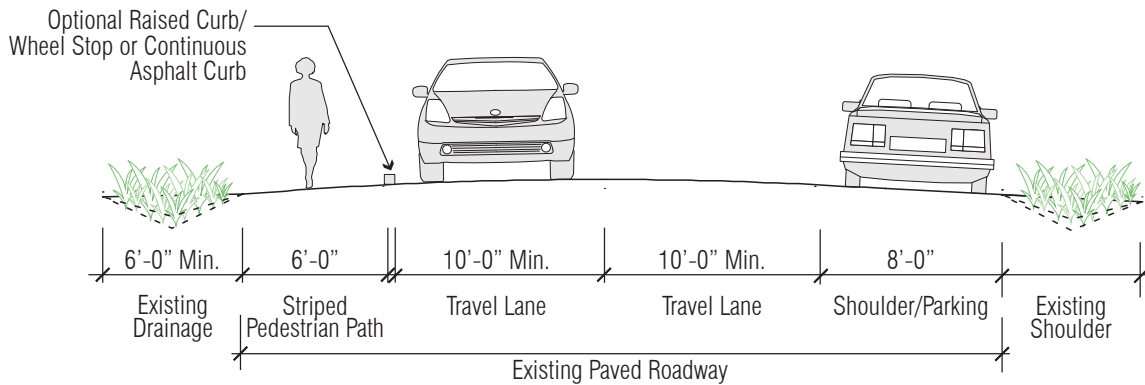

RURAL STREET SECTION SHOWING PEDESTRIAN FACILITY

Notes:

1. If parking is allowed, vehicles should park on the shoulder.
2. Rural streets often do not have curbs and gutters. The above are suggested solutions for implementing pedestrian improvements in rural areas.
3. The above design guideline is a recommendation for complete streets implementation and does not supersede a jurisdiction's existing standards.



CURB ZONE

DESIGN GUIDELINE
Bus Stops: Far Side Bus Stop

Far side stop placement is generally preferred as it reduces instances of buses waiting for traffic signals, reduces conflicts with right turning vehicles, and reduces frequency of pedestrians crossing the street in front of buses.

Near side placement may be preferred in selected instances, such as if major destinations are better aligned with a near side stop or if a low ridership route intersects a high ridership route. Nearside placement would also minimize walking distance for transferring riders.

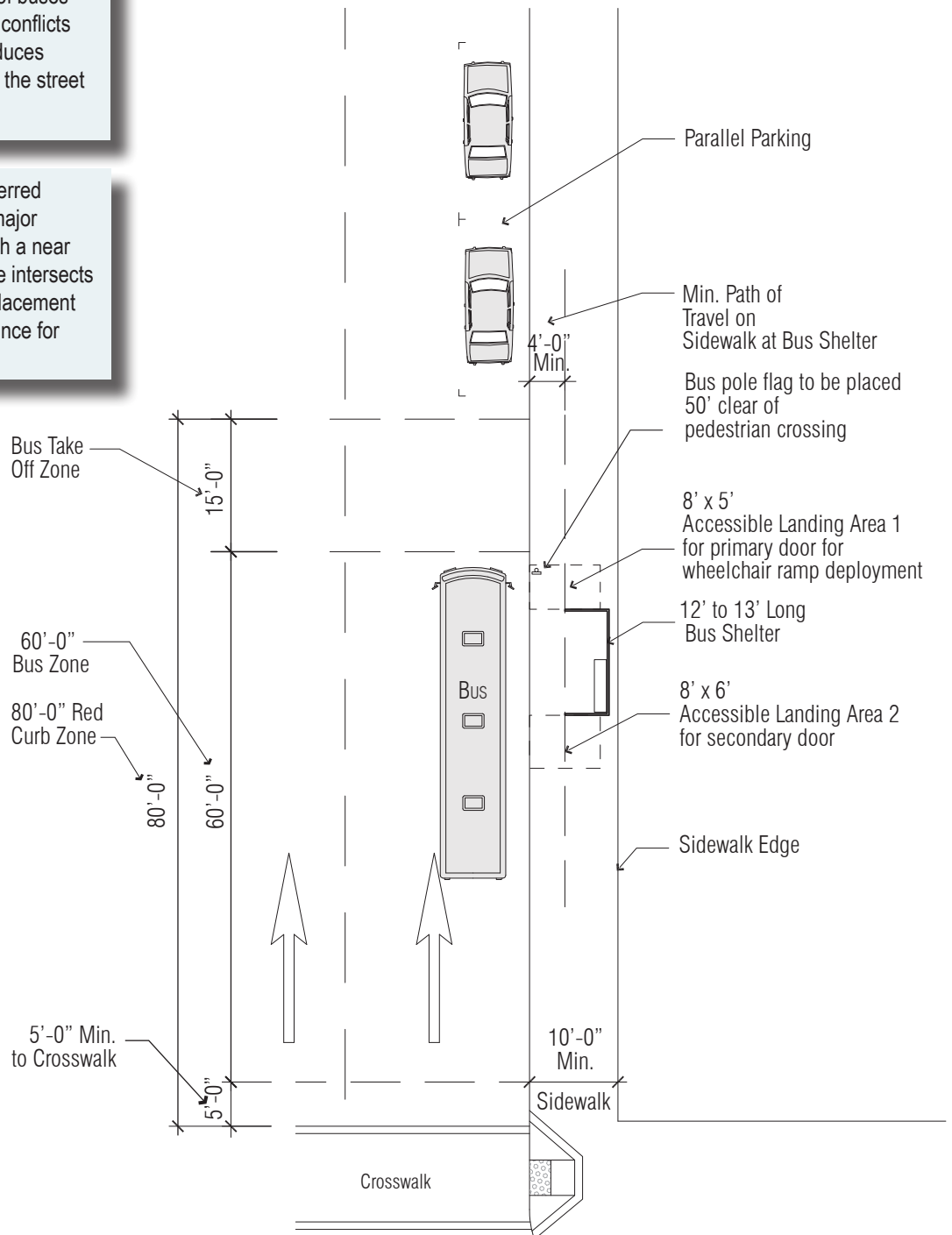

- Notes:
1. Far side bus stops are recommended over near side bus stops for complete streets implementation. Context consideration should be given to trip generators and Pedestrian Zones when determining far side versus near side bus stops.
 2. Source: Alameda-Contra Costa Transit District, 2004, "Fig. 8: Far Side Bus Stop Template," *Transit Friendly Streets: Making Streets Work for Transit*, page 5-30.
 3. The above design guideline is a recommendation for complete streets implementation and does not supersede a jurisdiction's existing standards.
 4. Design should consider bus stop use of articulated buses and a high incidence of multiple buses arriving simultaneously. Some bus stops may need to be longer than 60 feet.

DESIGN GUIDELINE Signage

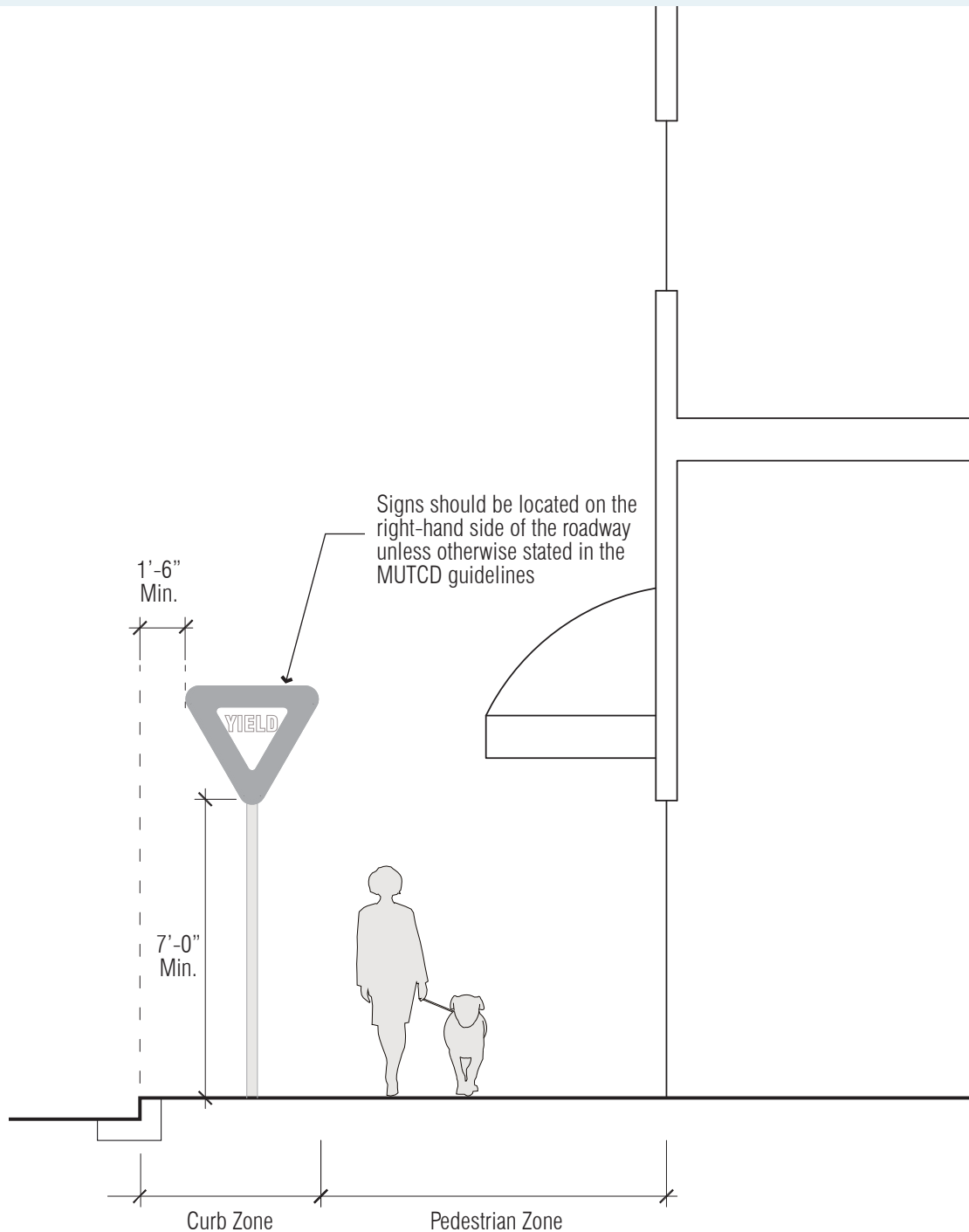

Notes:

1. Signage, wayfinding, traffic, or other should be kept clear of the Pedestrian Zone.
2. Signs may be placed on both sides of the road if special emphasis is required.
3. Sources: Manual on Uniform Traffic Control Devices (MUTCD), 2009 Edition Chapter 6F, Temporary Traffic Control Zone Devices, "Fig. 6F-1: Height and Lateral Location of Signs - Typical Installations," <http://mutcd.fhwa.dot.gov/htm/2009/part6/part6f.htm>, accessed July 22, 2016; MUTCD, 2009 Edition Chapter 2A, Lateral Offset, <http://mutcd.fhwa.dot.gov/htm/2009>, accessed August 2, 2016.
4. The above design guideline is a recommendation for complete streets implementation and does not supersede a jurisdiction's existing standards.
5. Objects in the buffer area between the vehicle lane and the Pedestrian Zone need to be 18 to 22 inches from the face of the curb (measure from the object on the curb side) and maintain ADA access from the back of the object to the back of the Pedestrian Zone.

DESIGN GUIDELINE
Landscaping and Utilities

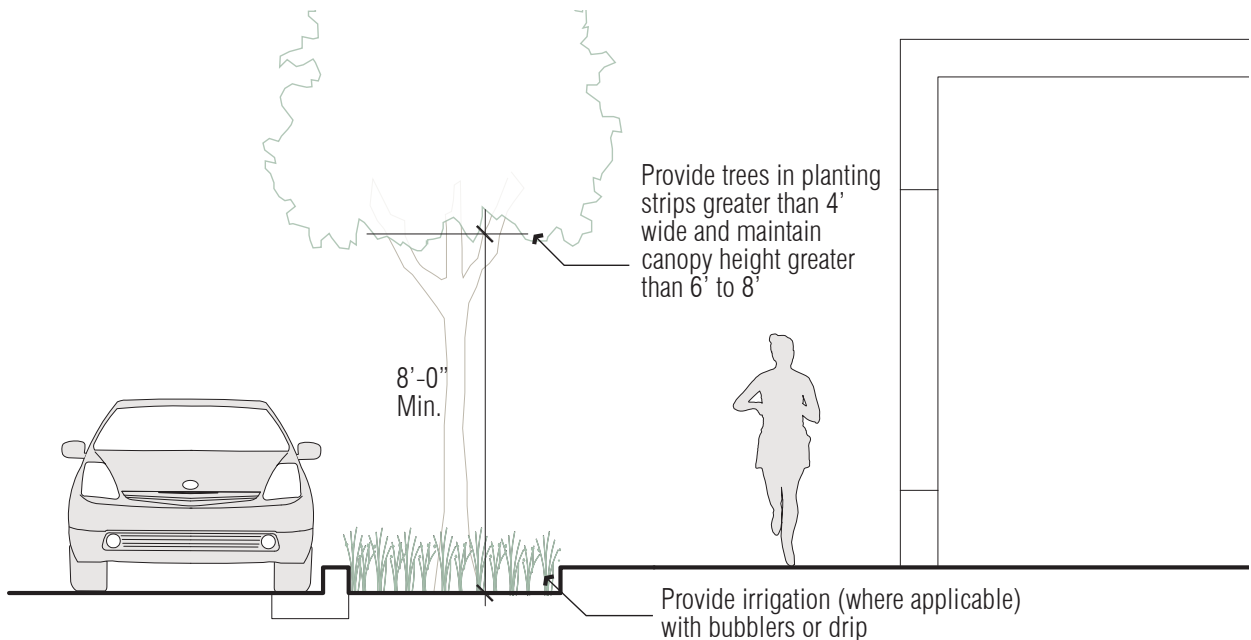
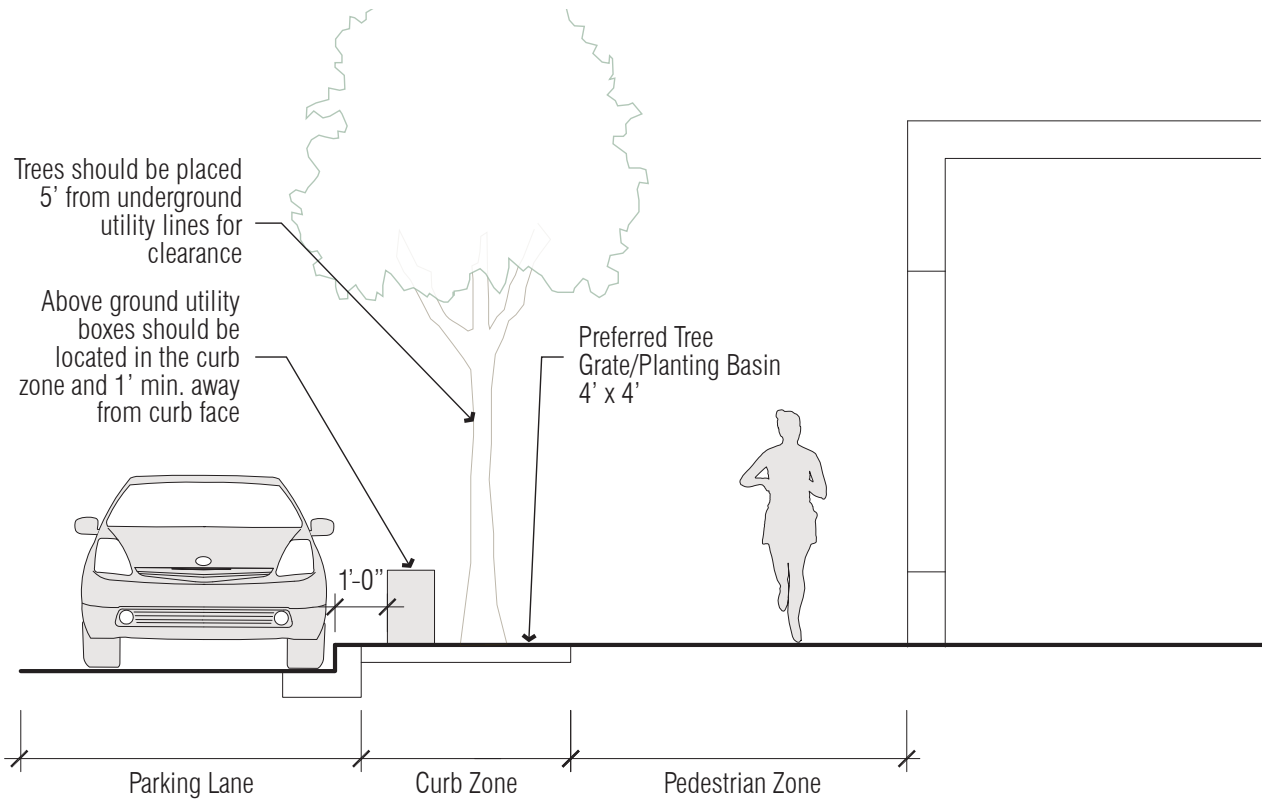

Notes:

1. Source: City and County of San Francisco, 2011, Chapter 6.1: Urban Forest, *Better Streets Plan*, page 165.
2. The above design guideline is a recommendation for complete streets implementation and does not supersede a jurisdiction's existing standards.
3. Use of native plant species is recommended. Trees should be selected considering their form, mature size, color, and texture. Accent trees, flowering species, with overarching canopies and medium density foliage are appropriate on wider streets such as boulevards. Trees with upright and columnar form are appropriate for narrow streets and medians.

DESIGN GUIDELINE Street Furnishings

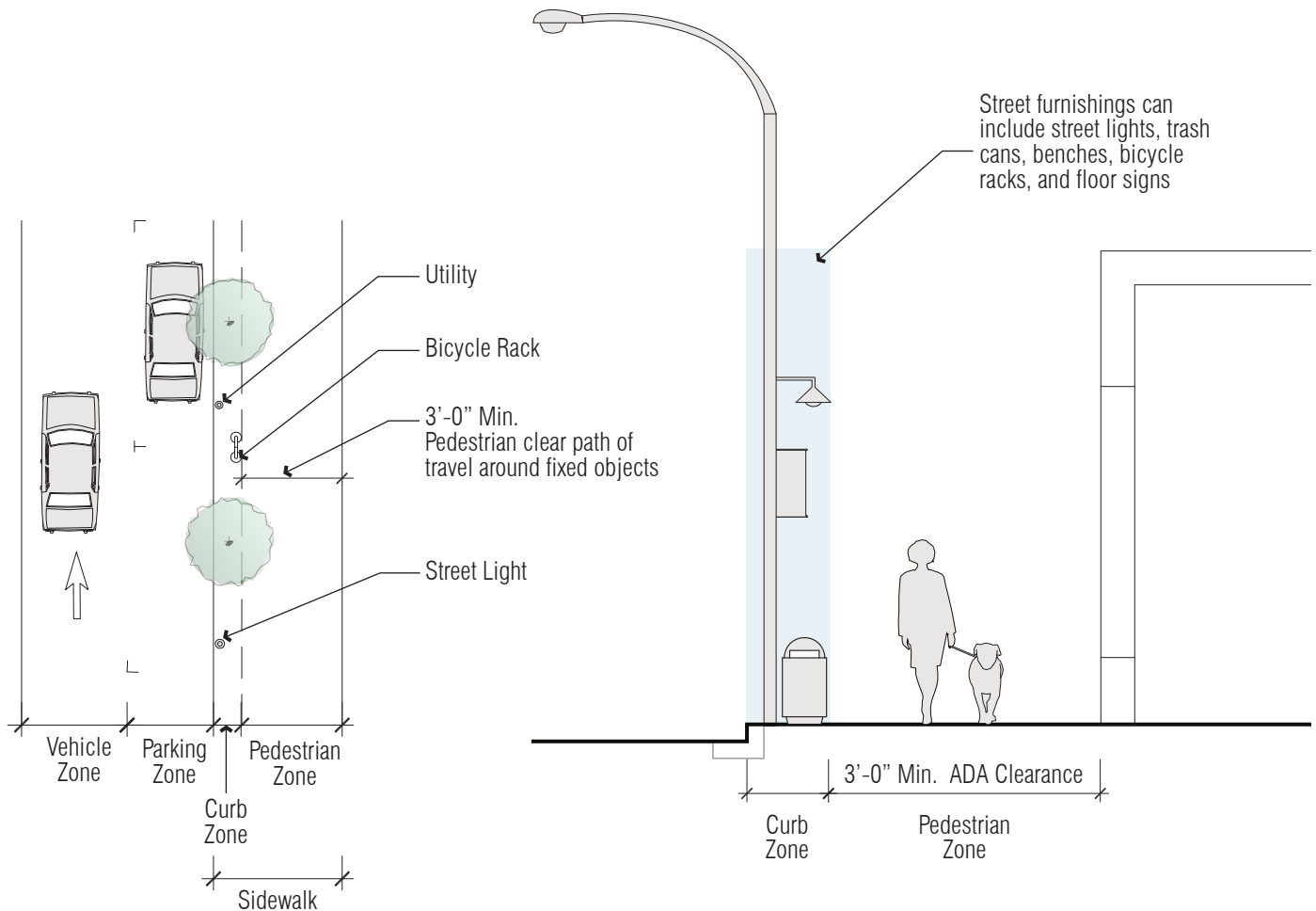

Notes:

1. All items, including trash cans, benches, and other street furnishings, should be placed at least 18" from curb face.
2. Street furnishings should be placed every 200' along commercial streets and should maintain a minimum 4' clear accessible route.
3. Source: City and County of San Francisco, 2011, Chapter 6: Streetscape Elements, *Better Streets Plan*, page 218; Americans with Disabilities Act, 1990.
4. The above design guideline is a recommendation for complete streets implementation and does not supersede a jurisdiction's existing standards.
5. Street furnishings should be confined to Curb Zone to maximum extent possible to minimize encroachment into pedestrian clear path of travel.

DESIGN GUIDELINE
Street Lighting

Light fixtures should be selected based on street and sidewalk widths. They may be placed parallel or in a staggered pattern depending upon the illumination required for the street.



Street lighting
Source: Change Lab Solutions

Street Light Cobra (LED Preferred) height may vary from 20' to 30', depending upon their spacing. Fixtures which direct light down towards the street and have an opaque top are recommended

Light fixture should be placed relative to the height and diameter of nearby tree canopy to avoid obstructing the light

Trees should be placed 5' away from underground utility lines, above ground utility poles, and 20' from street lights

Pedestrian lighting could be 12' to 15' high, depending upon their on-street placement. They may share poles with street lights wherever possible to minimize streetscape obstructions. Decorative fixtures having a glowing lens such as a "teardrop" or "acorn," can be used for commercial streets

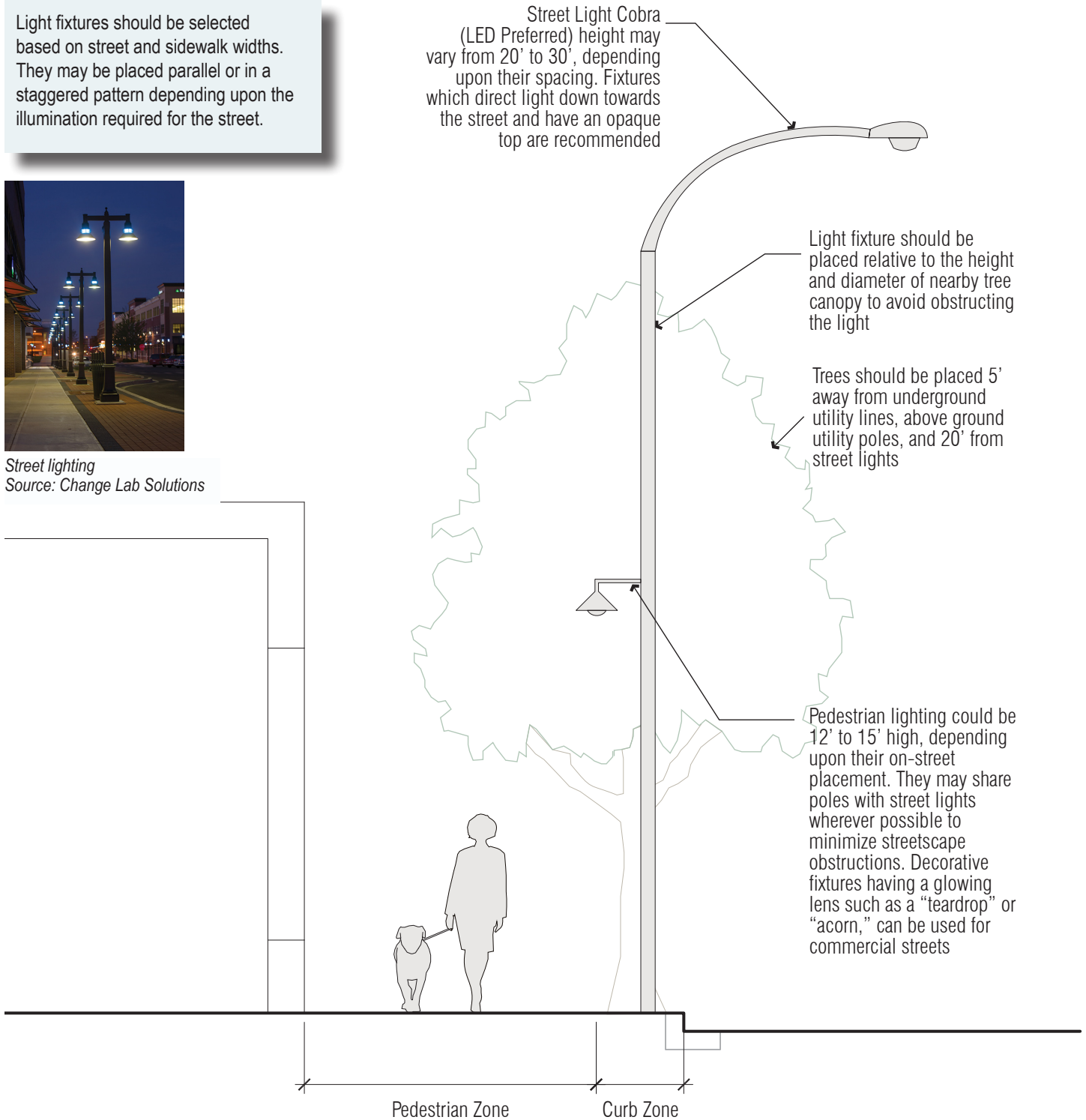

Notes:

1. Consider incorporating street lighting standards to provide visibility and safety for pedestrians.
2. Source: City and County of San Francisco, 2011, Chapter 6.3: Lighting, *Better Streets Plan*, pages 206 to 208.
3. The above design guideline is a recommendation for complete streets implementation and does not supersede a jurisdiction's existing standards.

DESIGN GUIDELINE

Green Infrastructure & Stormwater: At Bulb-out

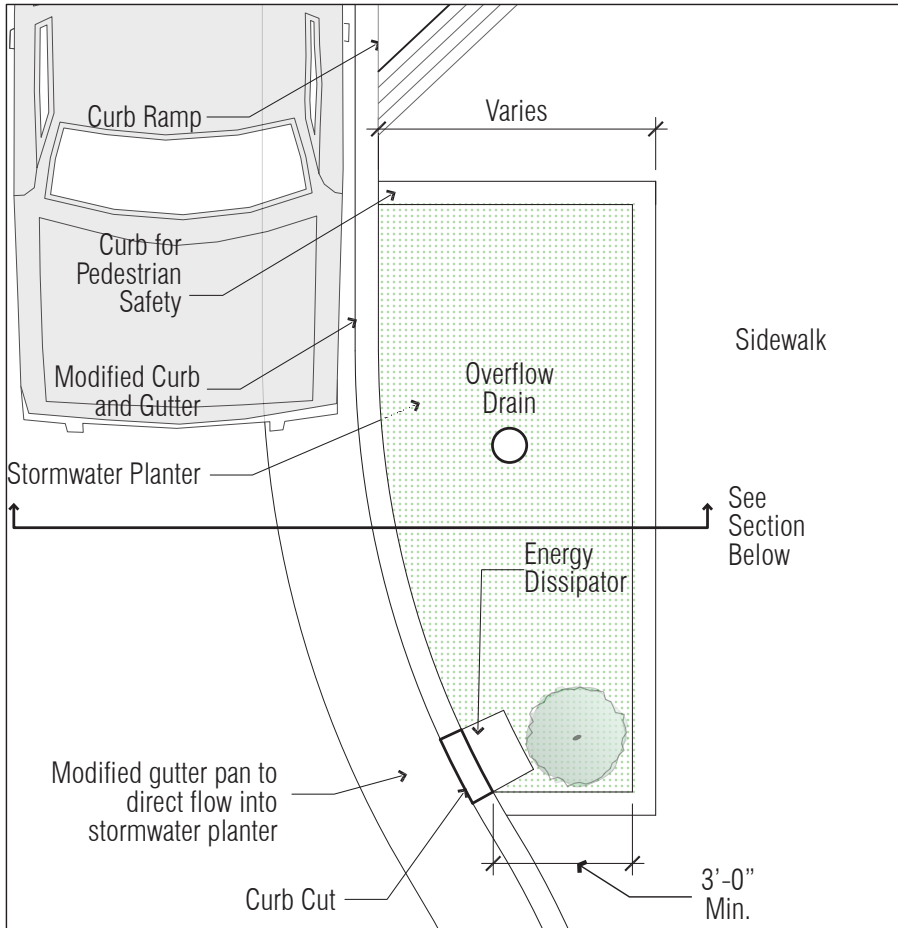

Stormwater planter at bulb-out
Source: US Environmental Protection Agency

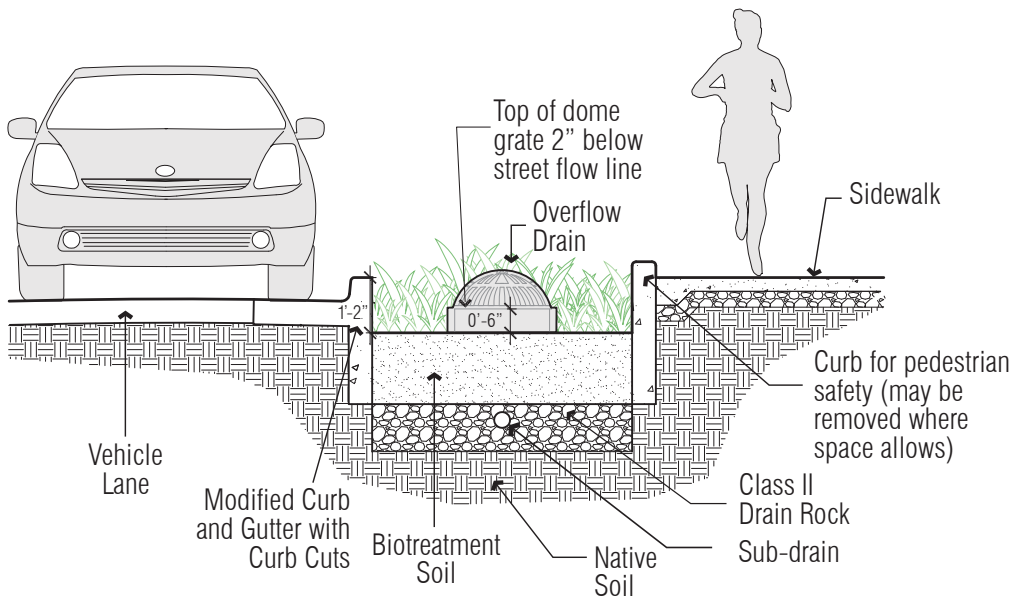

Notes:

1. Consider incorporating landscaping standards, including green infrastructure/stormwater requirements, for vegetation in the Curb Zone.
2. See Clean Water Program C.3 Stormwater Technical Guidance for more information on stormwater planters.
3. The above design guideline is a recommendation for complete streets implementation and does not supersede a jurisdiction's existing standards.
4. Square feet of the biotreatment area should be a minimum of 4% of total impervious drainage area.

DESIGN GUIDELINE

Green Infrastructure and Stormwater: At Parking

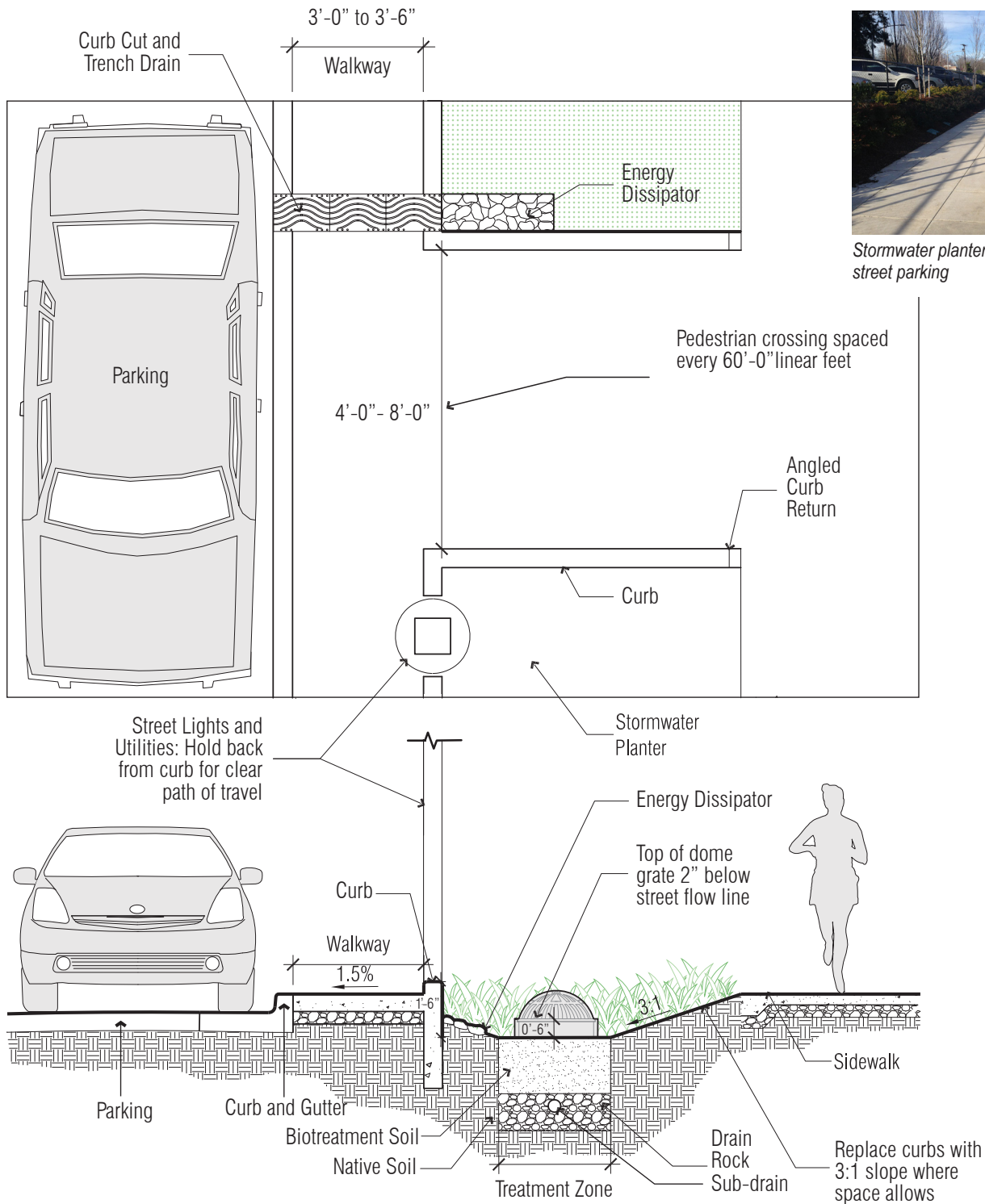

Stormwater planter between sidewalk and street parking

Notes:

1. Consider incorporating landscaping standards, including green infrastructure/stormwater requirements, for vegetation in the Curb Zone.
2. See Clean Water Program C.3 Stormwater Technical Guidance for more information on stormwater planters.
3. The above design guideline is a recommendation for complete streets implementation and does not supersede a jurisdiction's existing standards.
4. Square feet of the biotreatment area should be a minimum of 4% of total impervious drainage area.

DESIGN GUIDELINE
Bus Facilities: Bus Pull-out

Bus pull-outs are generally not preferred as they reduce pedestrian space and force buses to pull back into traffic. Bus pull-outs may be warranted if high-speed traffic presents rear-end collision risks.

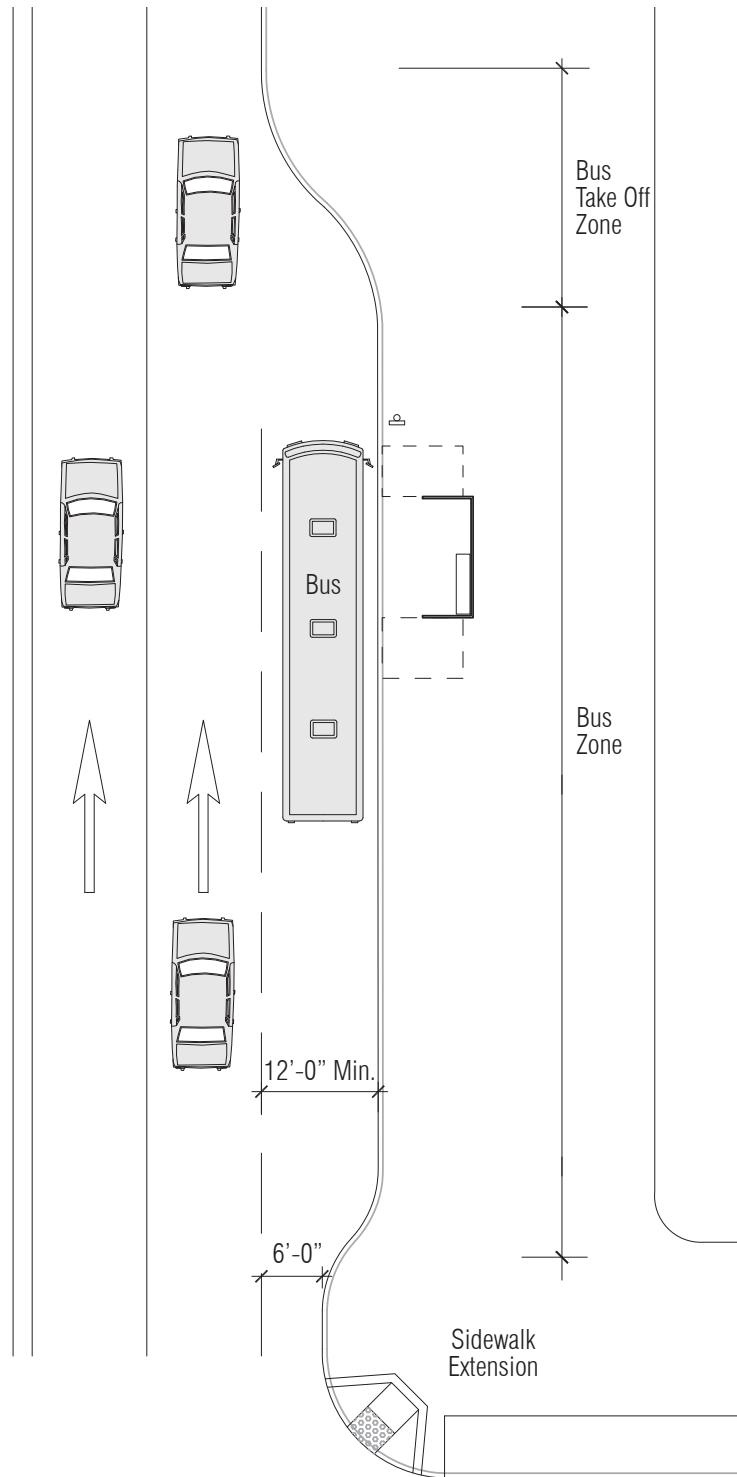

Notes:

1. Bus pull outs should be implemented on streets with a wider vehicle zone that allow for wider outside travel lanes.
2. Source: Federal Transit Administration, 1996, *Transit Cooperative Research Program (TRCP Report 19): Guidelines for the Location and Design of Bus Stops*, page 31; Alameda-Contra Costa Transit District, *Designing With Transit: Making Transit Integral to East Bay Communities*, http://www.actransit.org/wp-content/uploads/designing_with_transit2.pdf, accessed September 23, 2016.
3. The above design guideline is a recommendation for complete streets implementation and does not supersede a jurisdiction's existing standards.

DESIGN GUIDELINE

Bus Facilities: Bus Bulb

Bus bulbs eliminate delays to buses from pulling out of and back into traffic. Bus bulbs also create pedestrian waiting space and can enable shelters to be moved out of the Sidewalk Zone. Bus bulbs may also create on-street parking spaces as transition/taper zones are not needed.

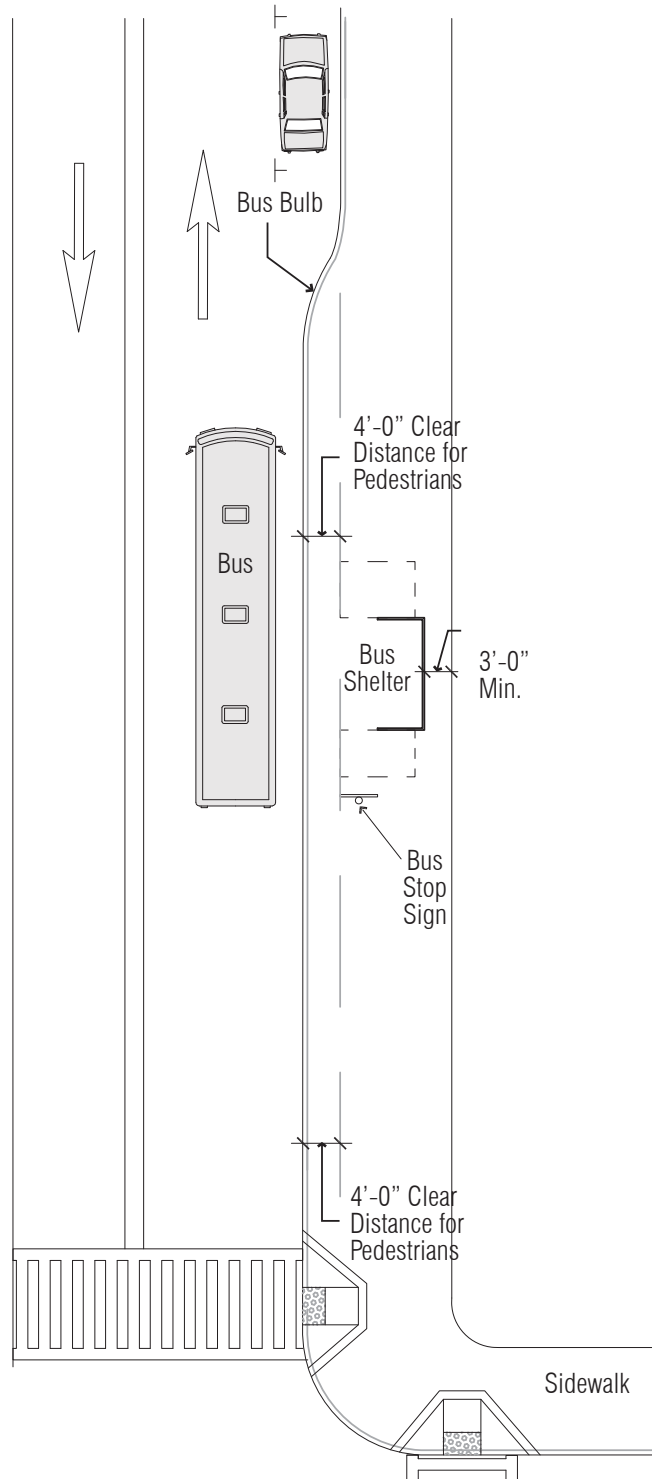

Notes:

1. Sources: Federal Transit Administration, *Transit Cooperative Research Program (TRCP Report 19): Guidelines for the Location and Design of Bus Stops*, http://nacto.org/docs/usdg/trcp_report_19.pdf, page 35; National Association of City Transportation Officials, *Urban Street Design Guide*, <http://nacto.org/publication/urban-street-design-guide/street-design-elements/curb-extensions/bus-bulbs>, accessed July 22, 2016; Alameda-Contra Costa Transit District, *Designing With Transit: Making Transit Integral to East Bay Communities*, http://www.actransit.org/wp-content/uploads/designing_with_transit2.pdf, accessed September 23, 2016.
2. The above design guideline is a recommendation for complete streets implementation and does not supersede a jurisdiction's existing standards.

BICYCLE ZONE

DESIGN GUIDELINE Class I Bikeway

Class I Bikeways provide a completely separated right-of-way for the exclusive use of bicycles and pedestrians with crossflow minimized.

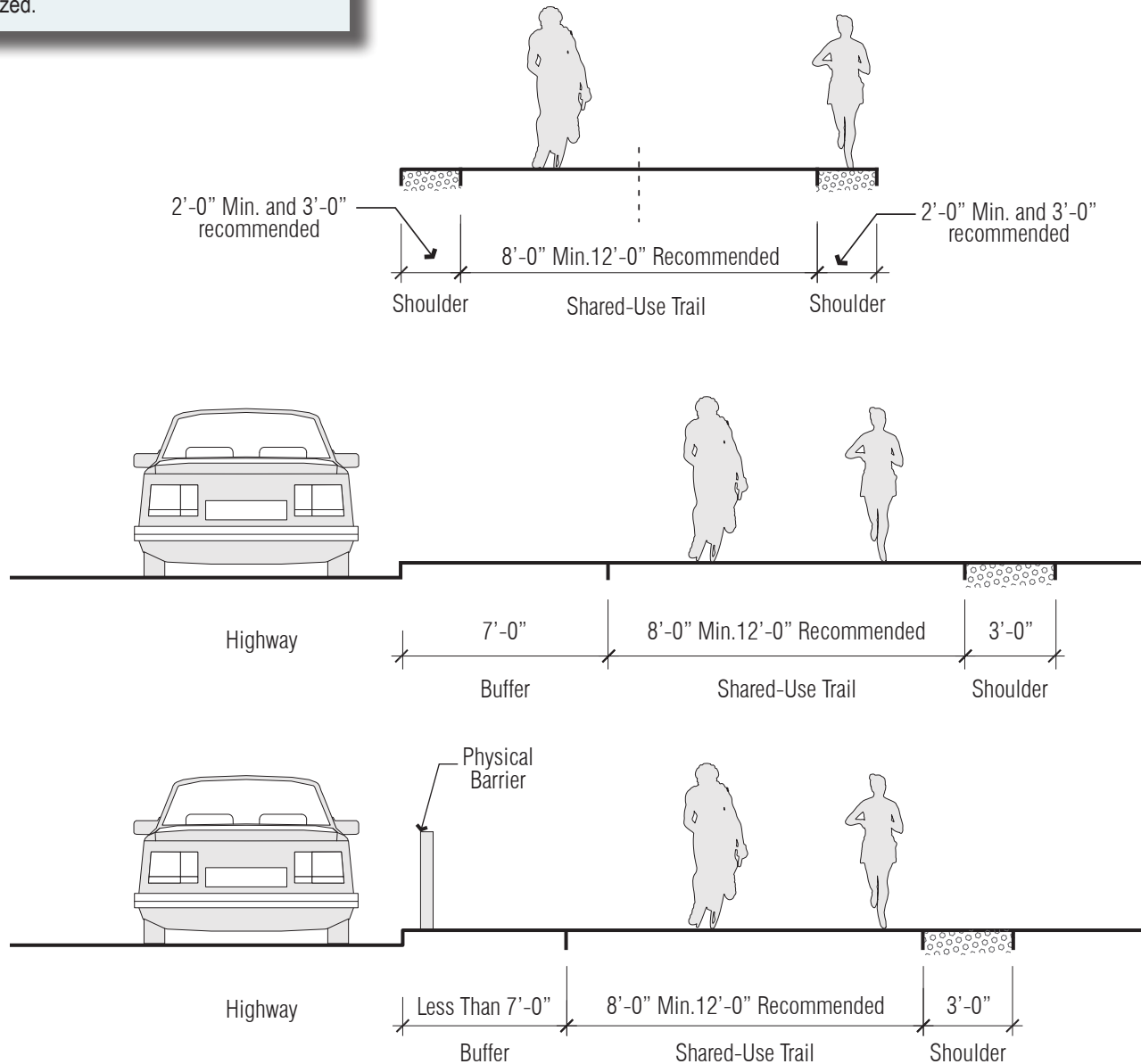

Notes:

1. Class I Bikeways are to be considered where opportunity coincides with planning.
2. A wider shoulder can attract more pedestrian traffic and potentially reduce conflicts with bicyclists on the bike path.
3. Sources: San Francisco Bay Trail, June 2016, *San Francisco Bay Trail Design Guidelines and Toolkit*, page 35; Fehr and Peers, 2014.
4. The above design guideline is a recommendation for complete streets implementation and does not supersede a jurisdiction's existing standards.

DESIGN GUIDELINE
Class II Bike Lanes

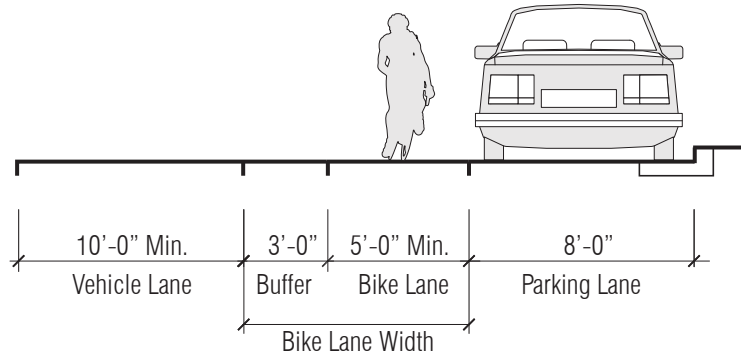

Class II Bike Lanes provide a striped lane for one-way bike travel on a street or highway.

Buffer spaces provide separation between cars and cyclists to increase comfort. Buffers can be used to narrow travel lanes, reducing speeds and injury severity. Buffer zones also minimize the impacts of double parking, loading, and vehicles pulling in and out of parking spaces on adjacent travel lanes. Buffer spaces can also accommodate overhanging larger vehicles.

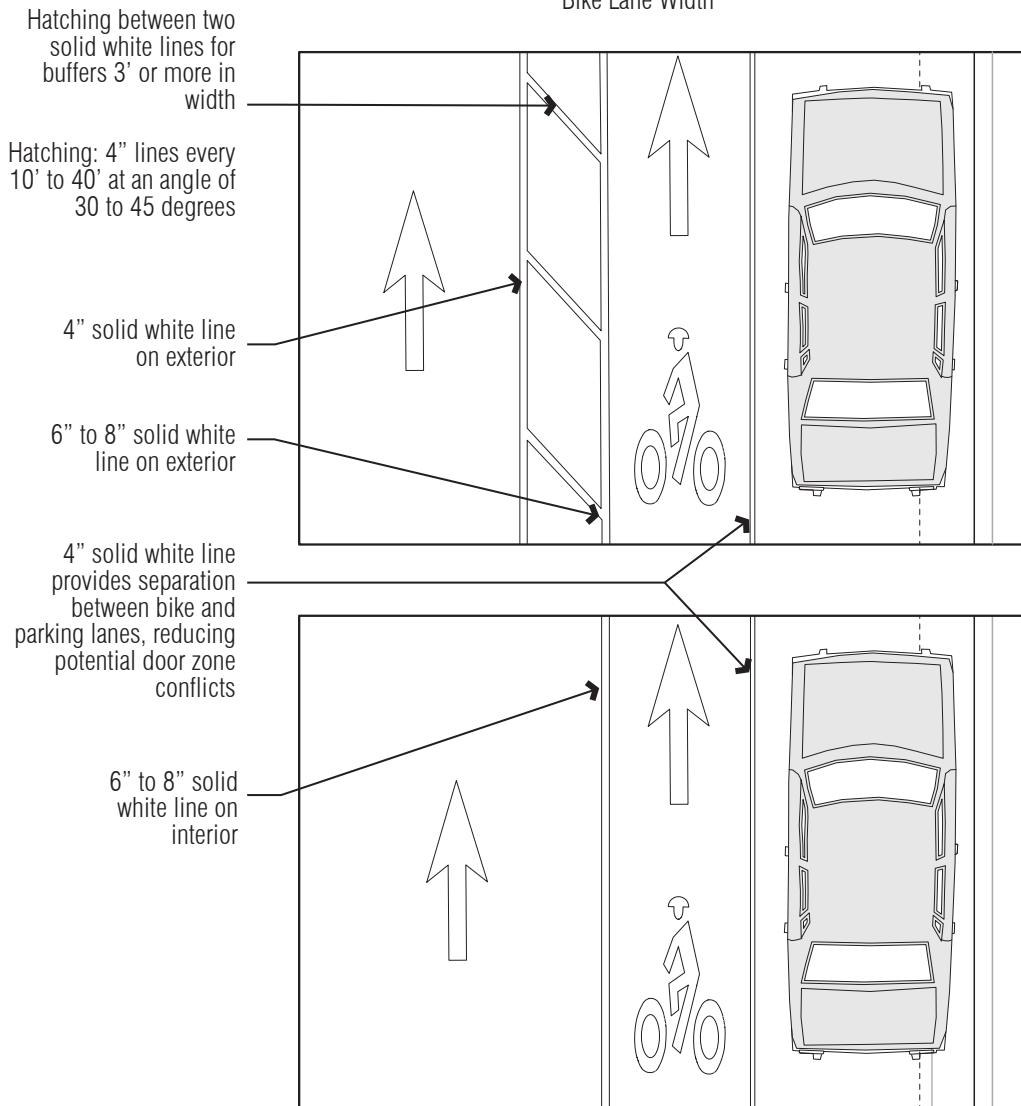

Bike lane with striped buffer



Bike lane with planter buffer

Notes:

1. It is recommended to provide a bicycle facility such as a Class II Bike Lane on all arterial and collector streets, although a Bicycle Zone is not required.
2. It is acceptable to provide a Class II Bike Lane with signage for streets with a narrower overall street width.
3. It is recommended to provide a wider Bicycle Zone to include a buffer between the Bicycle and Vehicle Zones or between the Bicycle and Parking Zones.
4. Source: National Association of City Transportation Officials, 2012, *Urban Bikeway Design Guide*, Second Edition, pages 11 to 19.
5. The above design guideline is a recommendation for complete streets implementation and does not supersede a jurisdiction's existing standards.

DESIGN GUIDELINE

Class II Bike Lanes: Total Available Width

RECOMMENDED PARKING LANE, BIKE LANE, AND BUFFER WIDTHS FOR VARIOUS LANE WIDTHS [1]

TOTAL AVAILABLE WIDTH (feet)	PARKING LANE WIDTH (feet)	BIKE LANE WIDTH (feet)	BUFFER WIDTH (feet)	METERED PARKING TEES FROM CURB FACE DISTANCE (feet)
12 [2]	7	5	0	7
13 [2]	8	5	0	8
14	9	5	0	7
15	10	5	0	8
16	9	5	2	7
17	10	5	2	8
18	10	6	2	8
19	10	6	3	8
20	11	6	3	9

If there is 19' or 20' of available width, buffers on both sides of the bike lane can be added.

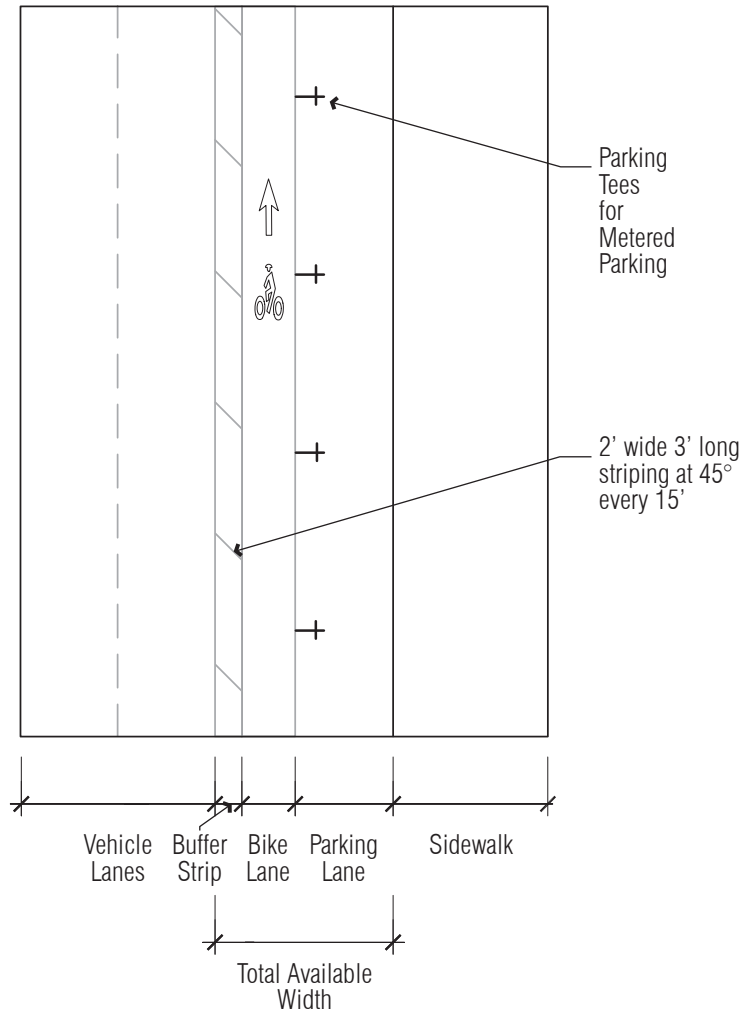

Notes:

1. Total available width indicates the combined width of the bike lane, parking lane, and optional buffer measured from the curb face to the outside bike lane stripe.
2. 12' and 13' total available widths apply to parking lanes with metered parking only. All other total available widths apply to parking lanes for both metered and unmetered parking.
3. If illegal parking within bike lanes is an issue, a 5' bike lane may be recommended.
4. When the bike lane is adjacent to a curb and gutter, it is recommended to maintain a minimum of 2.5' clear surface beyond the gutter.
5. When adjacent to a guardrail or other physical barrier, provide an additional 2' of lane width clearance.
6. Many jurisdictions prefer a 6' minimum bike lane to provide extra space for bicyclists to keep them safely outside the door zone and to ensure bicyclists are not riding in the gutter. The door zone refers to the area where bicyclists are vulnerable to being hit by an opening car door in the parking lane.
7. Source: City of Oakland Bureau of Engineering and Construction, December 2015, "Bike Lane and Buffer Widths," Bicycle Facilities Program.
8. The above design guideline is a recommendation for complete streets implementation and does not supersede a jurisdiction's existing standards.

DESIGN GUIDELINE

Bike Lanes: Modal Priorities and Posted Speed Limits

RECOMMENDED BIKE LANE WIDTHS (feet) FOR VARIOUS ARTERIAL/COLLECTOR MODAL PRIORITIES AND POSTED SPEED LIMITS				
POSTED SPEED LIMIT:	25 mph	30 to 35 mph	40 to 45 mph	> 50 mph
BICYCLE PRIORITY STREETS				
Class II Bike Lane	6 ft.	8 ft.	10 ft.	12 ft.
Class II Buffered Bike Lane ^[1]	9 ft.	11 ft.	13 ft.	15 ft.
Class IV Separated Bikeway with Raised Curb on Both Sides ^{[2][3]}	8 ft.	8 ft.	8 ft.	8 ft.
Class IV Separated Bikeway with Raised Curb on Only One Side	6 ft.	6 ft.	6 ft.	6 ft.
ALL OTHER MODAL PRIORITIES				
Class II Bike Lane	5 ft.	6 ft.	8 ft.	10 ft.
Class II Buffered Bike Lane ^[1]	8 ft.	9 ft.	11 ft.	13 ft.
Class IV Separated Bikeway with Raised Curb on Both Sides ^{[2][3]}	7 ft.	7 ft.	7 ft.	7 ft.
Class IV Separated Bikeway with Raised Curb on Only One Side	5 to 6 ft.	5 to 6 ft.	5 to 6 ft.	5 to 6 ft.

Notes:

1. Width includes the buffer width since the allocation of width between the bike lane versus the buffer strip can vary.
2. Indicated width does not include the width of the separation buffer strip since this can vary considerably depending on the design. The separation buffer width typically varies from as little as 3' with only flexible stanchions (tubular markers) to as much as 12' with on-street parking.
3. There is no change in width of Class IV facilities based on speed limit since cyclists are not riding adjacent to the traffic and still have to interact with motorists at intersections.
4. If on-street parking is permitted, an additional 8' is necessary for the (parallel) parking lane.
5. All widths are for one-way bikeways.
6. The above design guideline is a recommendation for complete streets implementation and does not supersede a jurisdiction's existing standards.

DESIGN GUIDELINE

Class II Bike Lanes: Signage

Pavement Markings

Bike lane striping should allow bicyclists to **follow a straight path** outside of the motor vehicle tread path.

- A 6 to 8 inch-wide, solid white line should be used at the right edge of the outside travel lane to designate the portion of the roadway for bicyclists.
- An optional solid white line can also be used at the outside of the bike lane between the bike and parking lanes.
- At an intersection where right turns are permitted, the bike lane line should terminate 100 to 200 feet prior to the intersection or be substituted by a dashed line marked up to the intersection.

Bike lane pavement markings should be used to further define bike lane space for bicyclists and motorists.

- These should be placed at the start of all bike lanes, on the far side of each intersection, and at other desired locations.
- The bike lane pavement marking should include a directional arrow and one of the accompanying word or bicycle symbols (Figures 1 and 2).
- Another option for pavement marking includes colored bike lanes. Colored bike lanes can be used in high-conflict areas to alert motorists to the presence of bicyclists and bike lanes.
- Markings can be painted or treated with thermoplastic. Thermoplastic paving is a preferred option because of its increased durability, reflectivity, and lack of toxic solvents.

Signage

- The bike lane signs (CA MUTCD R81) as shown in Figure 3 should be placed at the beginning of each designated bike lane, on the far side of arterial intersections, at major changes in direction, and at ½ mile intervals.
- The BEGIN (CA MUTCD R81A) and END (CA MUTCD R81B) signs may be used below the required R81-sign to mark the beginning or end of a bike lane (Figure 4). If bike lane pavement markings are used it is not necessary to include the bike lane sign at each pavement marking.
- Signs may also be used to state BICYCLE WRONG WAY (CA MUTCD R5-1b – See Figure 5) on the back of bike lane signs to reinforce appropriate traffic flow for bicyclists.



Figure 1 Bike lane pavement marking with accompanying word symbol



Figure 2 Additional option for bike lane pavement marking



Colored bike lane



Signage indicating shared use of the road



Figure 3 CA MUTCD R81 required signage for Class II bike lane



Figure 4 Optional signage for the start and end of bike lanes



Figure 5 Optional Wrong Way signage

Notes:

1. Sources: Caltrans Highway Design Manual (HDM), California Manual on Uniform Traffic Control Devices (CA MUTCD), and American Association of State Highway and Transportation Officials (AASHTO) Guide for the Development of Bicycle Facilities.

DESIGN GUIDELINE

Class II Bike Lanes: Striping and Pavement Markings

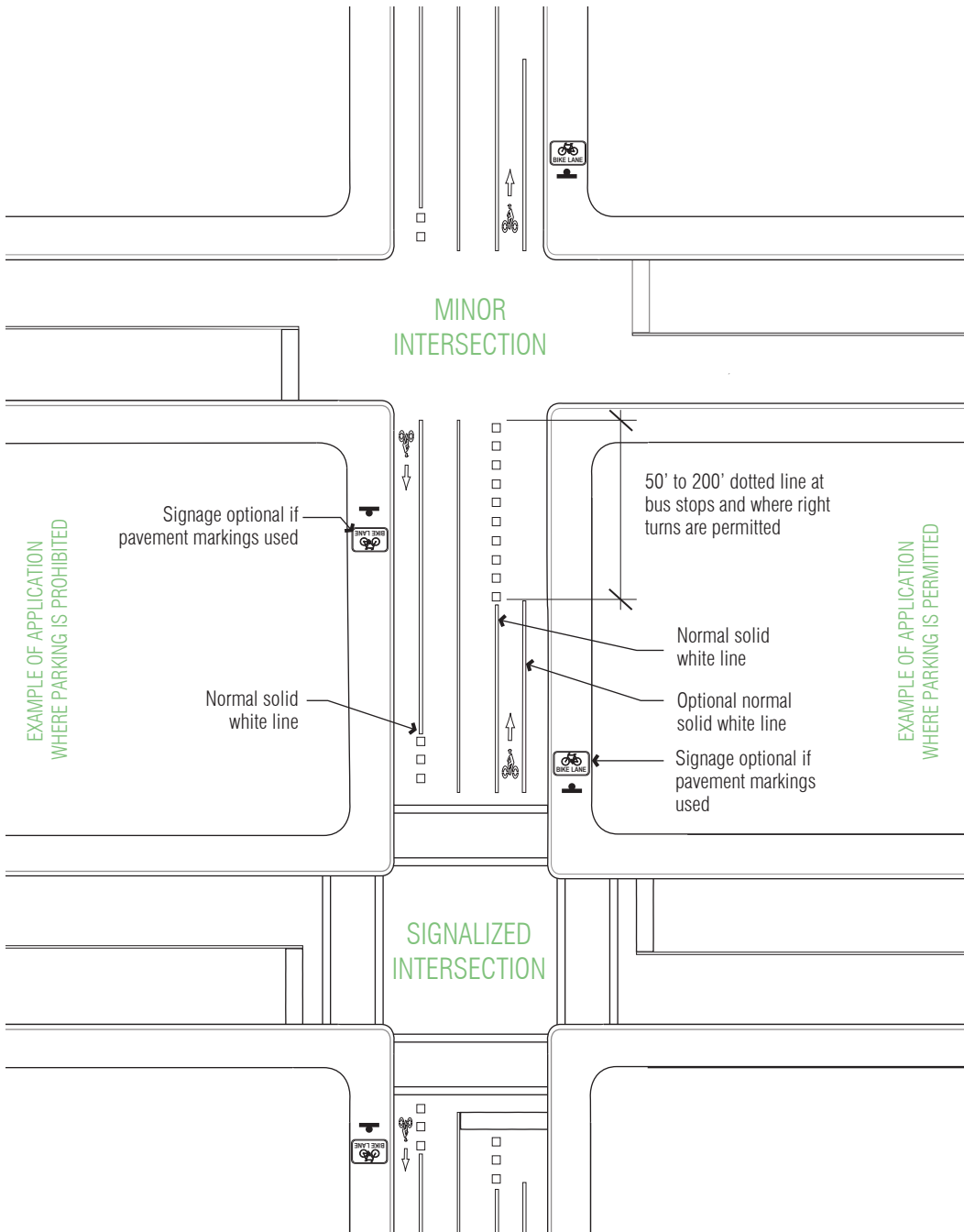

Dotted bike lane marking through street intersection for added bicyclist safety

Notes:

1. Sources: Federal Highway Administration (FHWA), 2006, FHWA University Course on Bicycle and Pedestrian Transportation, "Figure 15-10. Illustration. Typical pavement markings for bike lane on two-way street," <http://www.fhwa.dot.gov/publications/research/safety/pedbike/05085/chapt15.cfm>, accessed August 17, 2016; American Association of State Highway and Transportation Officials (AASHTO), 1999, *Guide for the Development of Bicycle Facilities*.
2. The above design guideline is a recommendation for complete streets implementation and does not supersede a jurisdiction's existing standards.

DESIGN GUIDELINE

Class II Bike Lanes: Left Turn Treatments

Length of left-turn pocket should match the length of the automobile left-turn pocket so that the cyclist may enter the left-turn lane at the very beginning of the left-turn pocket and be more protected from motorized traffic.

In certain locations, for example where the adjacent through lane is high-speed or where the left-turn lane exceeds 200' in length, consider a 3' wide buffer (with or without flexible delineators) for the last 100 feet of the turn lane. The buffer would be located between the through lane and the bike left-turn pocket.

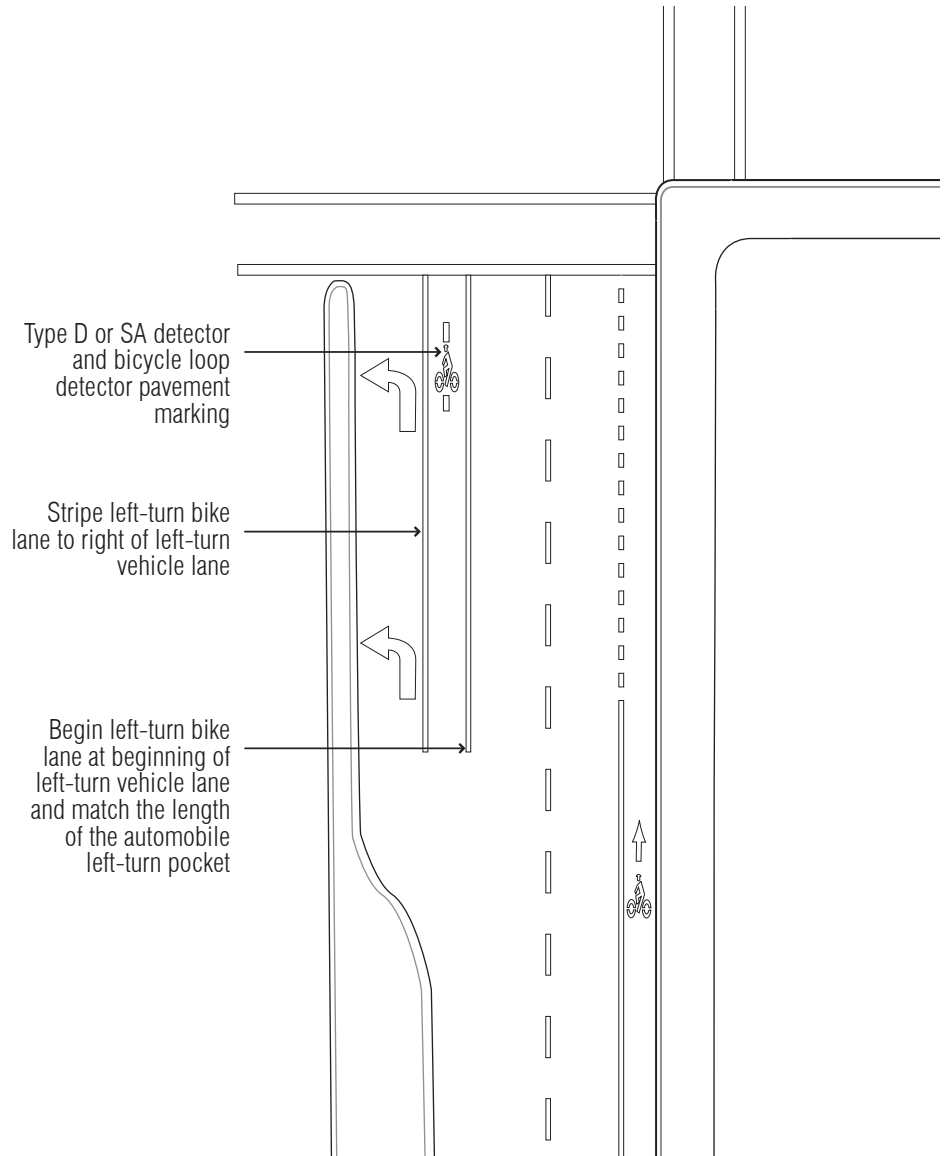

Notes:

1. Sources: Federal Highway Administration (FHA), 2006, *FHA University Course on Bicycle and Pedestrian Transportation*, "Figure 15-11. Illustrations. Possible configurations for bike lane and right-turn lane," <http://www.fhwa.dot.gov/publications/research/safety/pedbike/05085/chapt15.cfm>, accessed August 17, 2016; American Association of State Highway and Transportation Officials (AASHTO), 1999, *Guide for the Development of Bicycle Facilities*.
2. The above design guideline is a recommendation for complete streets implementation and does not supersede a jurisdiction's existing standards.

DESIGN GUIDELINE

Class II Bike Lanes: Right Turn Treatments

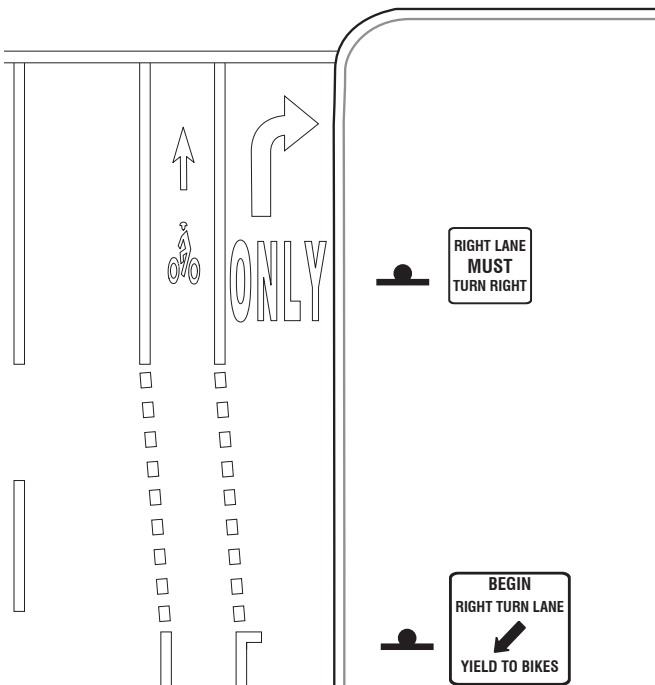

PARKING LANE BECOMING RIGHT-TURN LANE

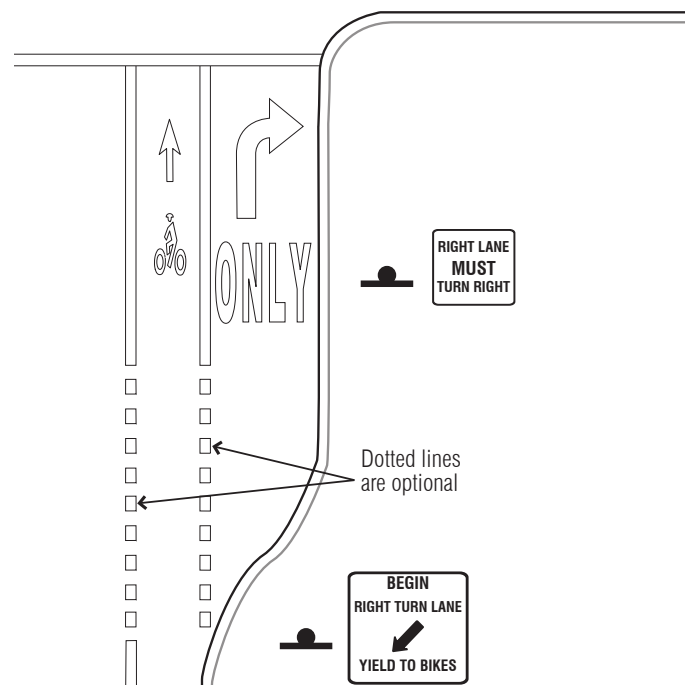

BIKE LANE POCKET AT RIGHT-TURN ONLY LANE

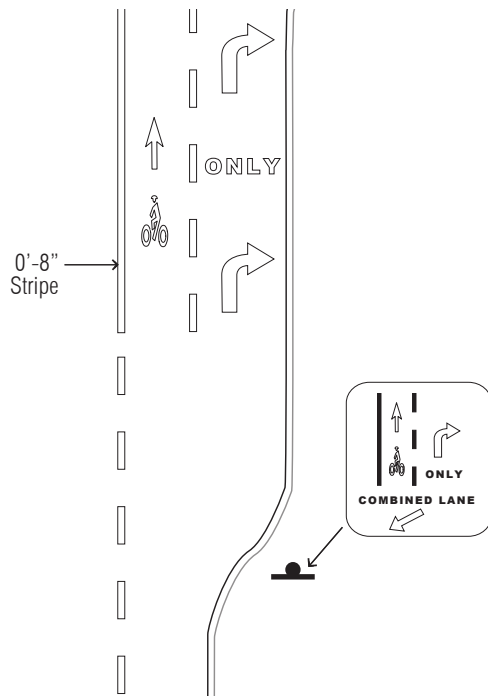

SHARED RIGHT-TURN/BICYCLE THROUGH LANE



Bicycle-through-lane adjacent to right-turn lane



Bicycle right-turn lane adjacent to right-turn lane for vehicles



Shared right-turn lane with "sharrow" marking for Class III Bike Routes

Notes:

1. Sources: Federal Highway Administration (FHA), 2006, *FHA University Course on Bicycle and Pedestrian Transportation*, "Figure 15-11. Illustrations. Possible configurations for bike land and right-turn lane," <http://www.fhwa.dot.gov/publications/research/safety/pedbike/05085/chapt15.cfm>, accessed August 17, 2016; American Association of State Highway and Transportation Officials (AASHTO), 1999, *Guide for the Development of Bicycle Facilities*.
2. The above design guideline is a recommendation for complete streets implementation and does not supersede a jurisdiction's existing standards.

DESIGN GUIDELINE

Class II Bikeways: Lane Reduction Transition Markings

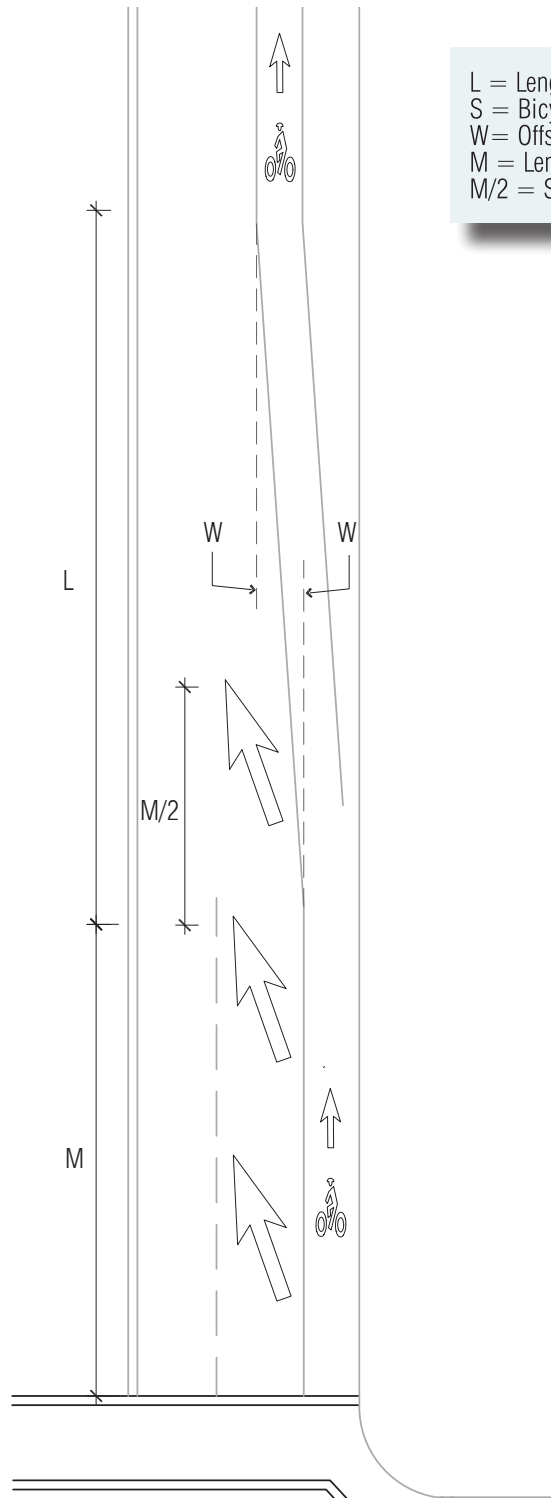

L = Length in feet or $W \cdot S$
 S = Bicycle approach speed in miles per hour
 W = Offset in feet
 M = Length of skip strip in feet: $M = (2L)/3$ & $M \geq 55'$
 M/2 = Spacing of arrows in feet

Notes:

1. Source: City of Oakland Bureau of Engineering and Construction, December 2015, "Lane Reduction Transition Markings with Bike Lane," Bicycle Facilities Program.
2. The above design guideline is a recommendation for complete streets implementation and does not supersede a jurisdiction's existing standards.

DESIGN GUIDELINE
Green Bike Lane

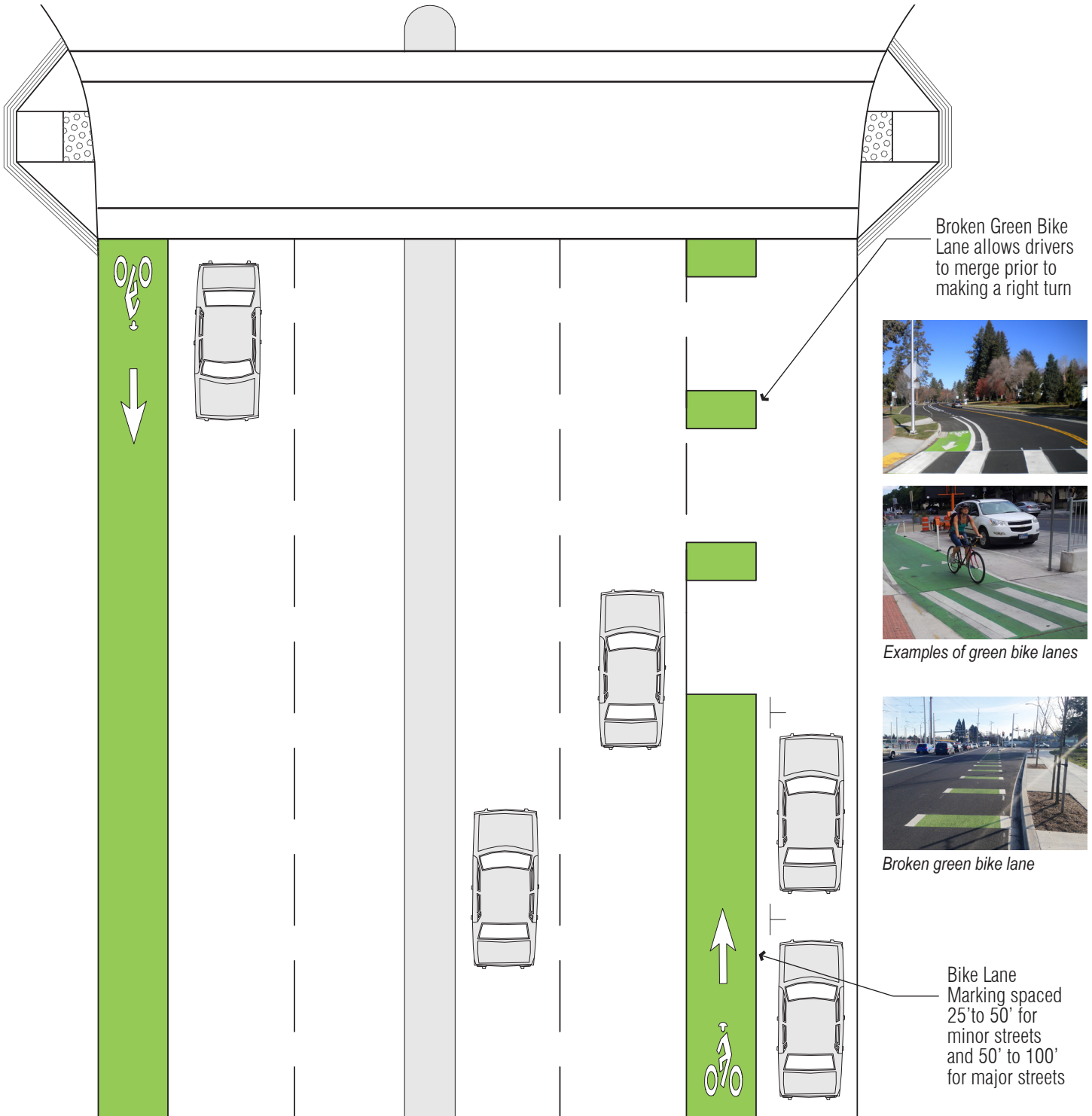

Notes:

1. It is recommended to provide green lanes in an urban land use typology.
2. Source: Bialick, Aaron, StreetsBlogSF, May, 11, 2012, "SFMTA Draft Design Standards to Streamline Innovative Bike Treatments," <http://sf.streetsblog.org/2012/05/11/sfmta-drafting-design-standards-to-streamline-innovative-bike-treatments>, accessed July 22, 2016.
3. The above design guideline is a recommendation for complete streets implementation and does not supersede a jurisdiction's existing standards.

DESIGN GUIDELINE Class III Bike Route

Class III Bike Routes provide for shared use with motor vehicle traffic. Shared lane stencils or “sharrows” assist cyclists with lane positioning, provide wayfinding, and alert motorists of the presence of bicycles.



Examples of sharrow markings on the roadway

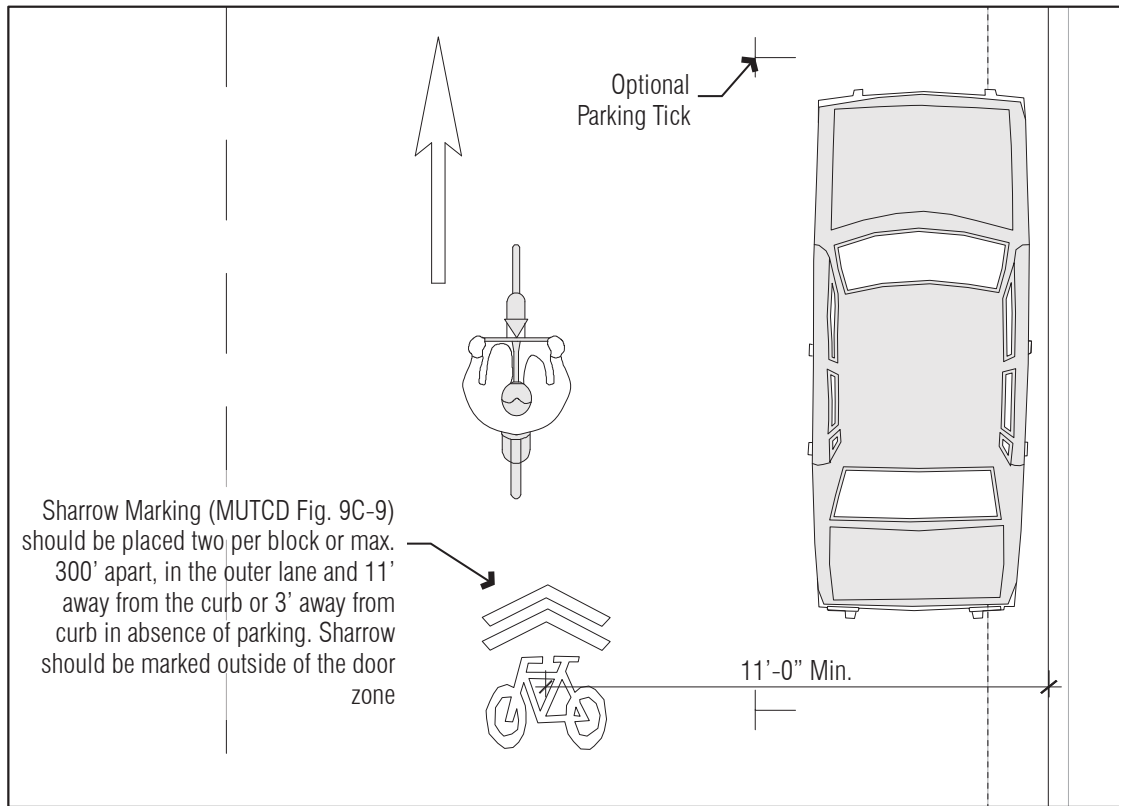
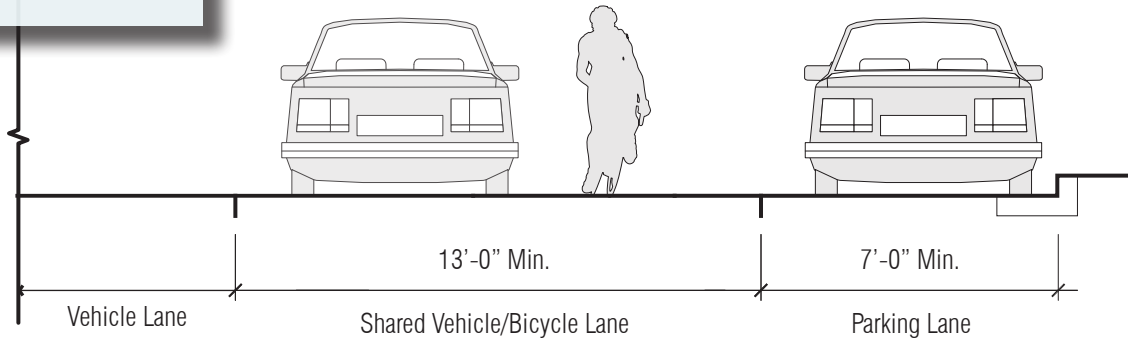

Notes:

1. It is recommended to provide a shared use bicycle facility such as a Class III Bike Route on local streets with lower traffic volumes and speeds.
2. Sources: City of Redmond, 2012, *Bicycle Facilities Design Manual*, page 24; National Association of City Transportation Officials, 2012, *Urban Bikeway Design Guide*, Second Edition, pages 179 to 181.
3. The above design guideline is a recommendation for complete streets implementation and does not supersede a jurisdiction's existing standards.

DESIGN GUIDELINE Class III Enhanced: Bike Boulevard

Bicycle boulevards are local (often residential) streets where bicycle traffic is given right-of-way wherever feasible, primarily by removing unwarranted STOP signs, which improves the travel time for bicyclists

ENHANCED TREATMENTS FOR BICYCLE BOULEVARDS



Special bikeway signs and BIKE BLVD pavement markings



Directional signs to common destinations, including distance and travel time for cyclists



Gateway treatments at main entrance points to the bicycle boulevard

CRITERIA FOR SELECTING LOCATION OF A BICYCLE BOULEVARD

Residential street

Existing low volumes (under 3,000 average daily trips)

No or very little commercial land uses

Roadway parallel to a major arterial or a high-traffic collector street (within approximately 0.25 mile)

Roadway is not a transit or truck route

Roadway is reasonably continuous with few jogs and turns

Bicycle Boulevard can ideally extend for at least two miles

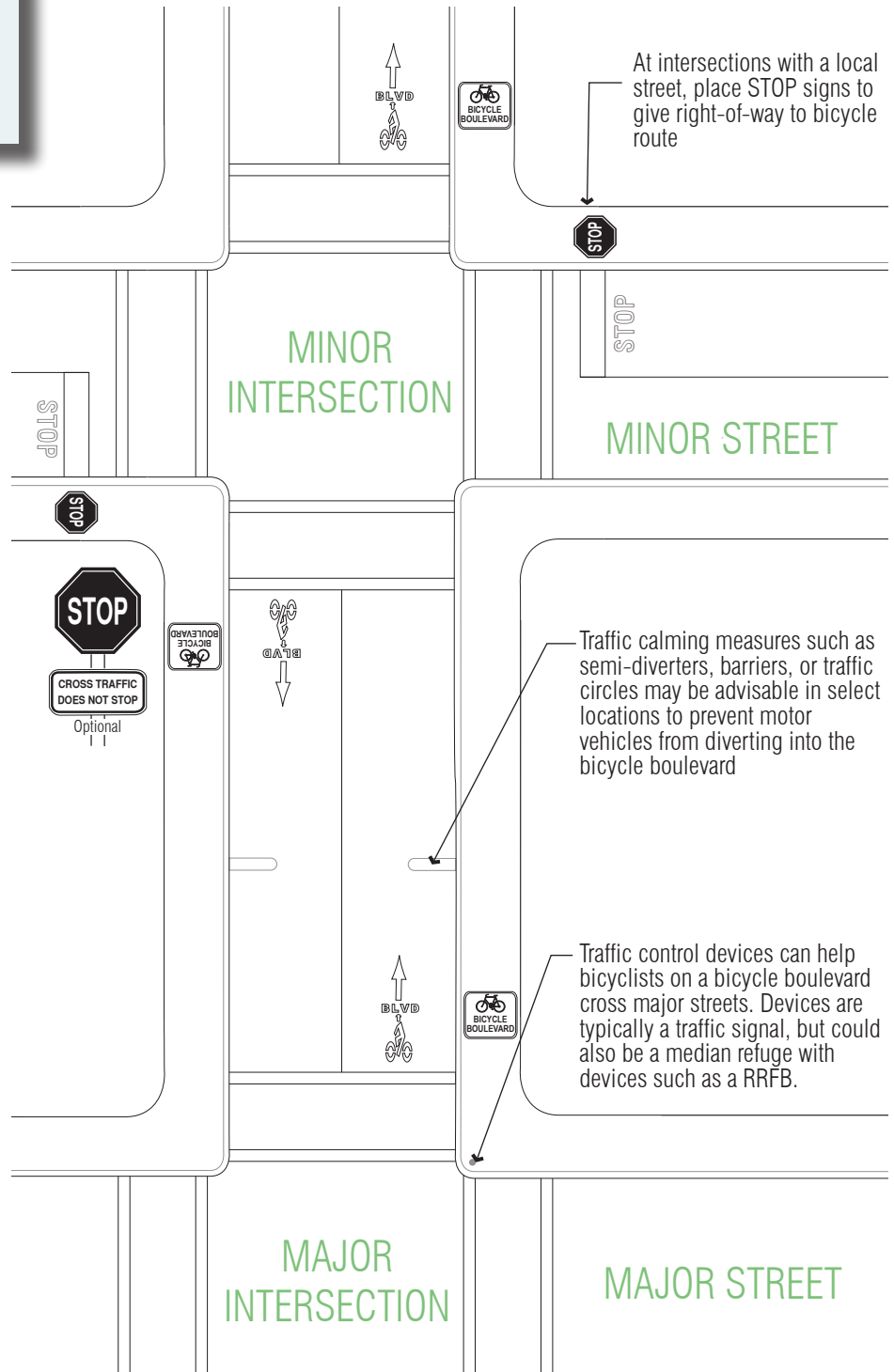

Notes:

1. It is recommended to provide a shared use bicycle facility such as a Class III Enhanced Bicycle Boulevard on local streets with lower traffic volumes and speeds.
2. The above design guideline is a recommendation for complete streets implementation and does not supersede a jurisdiction's existing standards.

DESIGN GUIDELINE

Class IV Protected Bike Lane: Cycle Track

Class IV Protected Bike Lanes provide exclusive use of bicycles, including separation in the form of physical barriers or grade separation, between the bicycle lane and vehicle lane.

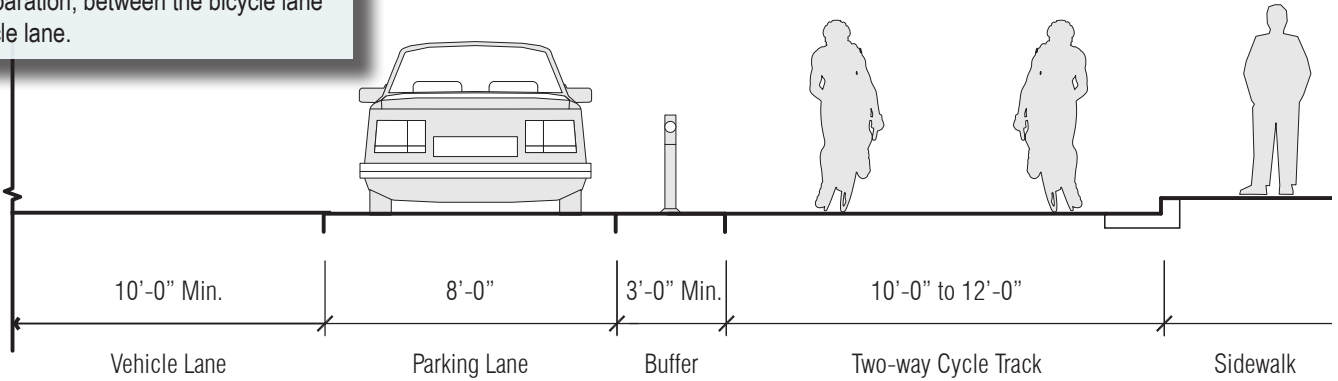

Hatching between two solid white lines for buffers 3' or more in width (for buffers with only pavement markings)

Hatching: 4" lines every 10' to 40' at an angle of 30 to 45 degrees

Tubular markers in buffer space are one option for a physical barrier. Other options include planters, bollards, or a raised curb.

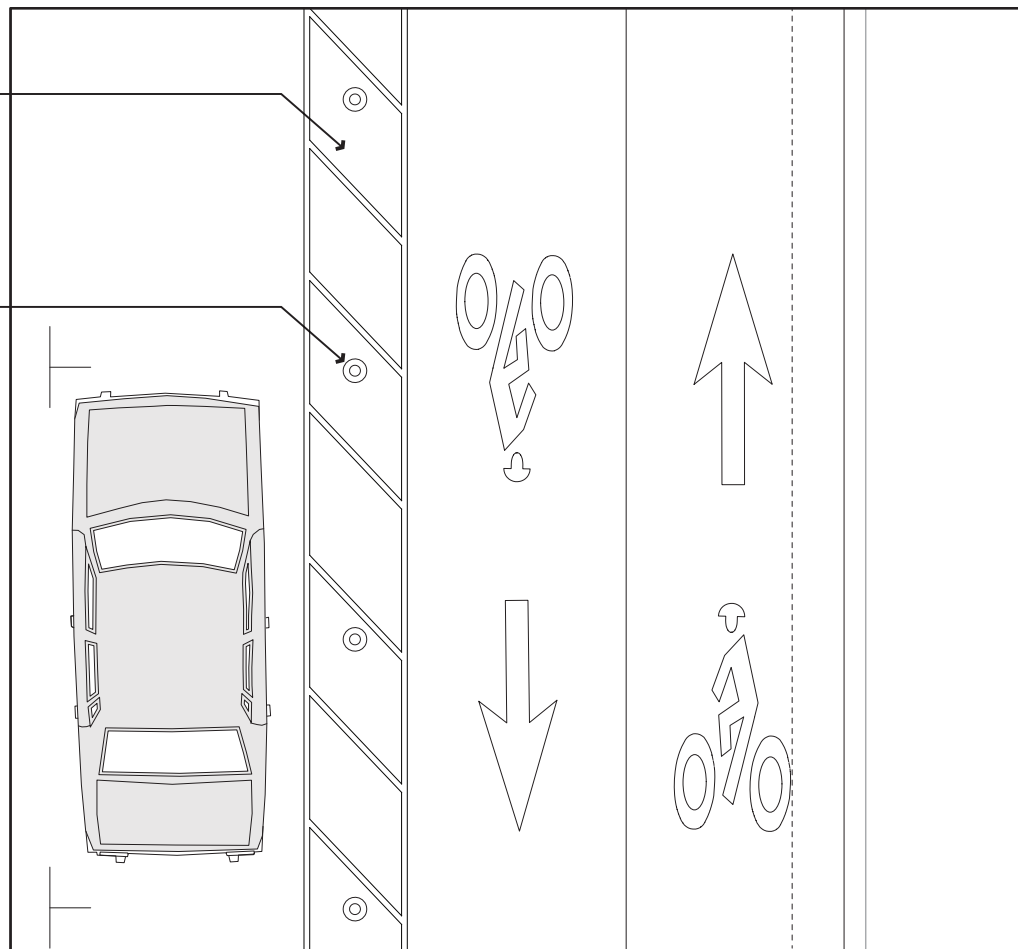

Cycle track pavement markings



Protected cycle track

Notes:

1. It is recommended to provide a wider Bicycle Zone to include a buffer between the Bicycle and Vehicle Zones or between the Bicycle and Parking Zones (Class IV Protected Bike Lane).
2. Sources: California Department of Transportation, December 2015, "Class IV Bikeway Guidance: Separated Bikeways/Cycle Tracks," Design Information Bulletin Number 89, pages 2 to 6; National Association of City Transportation Officials, 2012 Second Edition, *Urban Bikeway Design Guide*, pages 61 to 63.
3. The above design guideline is a recommendation for complete streets implementation and does not supersede a jurisdiction's existing standards.

DESIGN GUIDELINE

Class IV Protected Bike Lane: On-Street with Parking

Class IV Protected Bike Lanes provide exclusive use of bicycles, including separation in the form of physical barriers or grade separation, between the bicycle lane and vehicle lane.

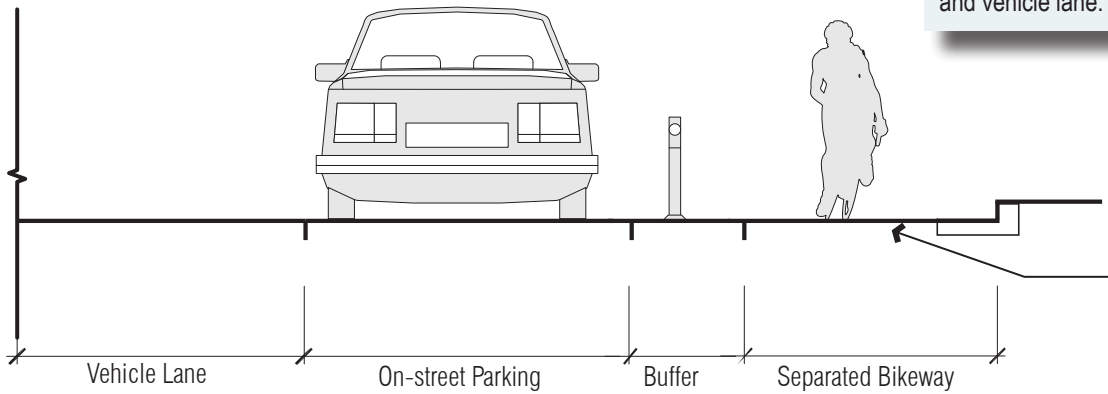

7' minimum for areas with high bicyclist volume or at an uphill section to allow bicyclists enough room for passing other bicyclists

Hatching between two solid white lines for buffers 3' or more in width (for buffers with only pavement markings)

Hatching: 4" lines every 10' to 40' at an angle of 30 to 45 degrees

Tubular markers in buffer space are one option for a physical barrier. Other options include planters, bollards, or a raised curb.

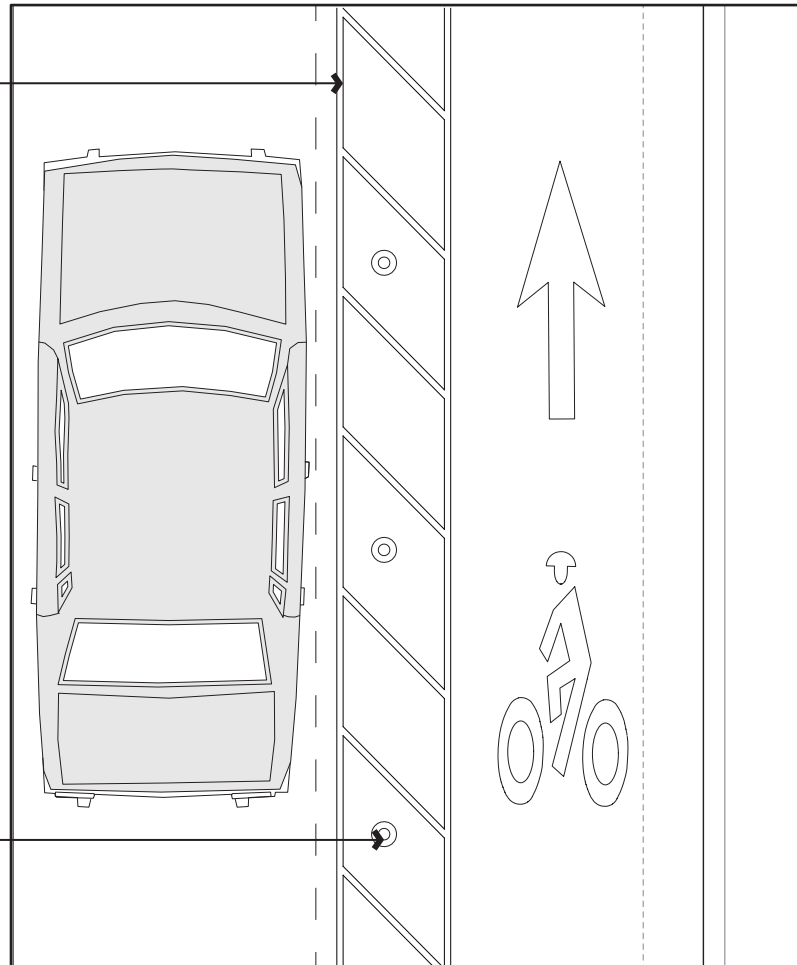

Bike lanes protected by on-street parking



No Parking Signage
Source: Seattle DOT

Notes:

1. It is recommended to provide a wider Bicycle Zone to include a buffer between the Bicycle and Vehicle Zones or between the Bicycle and Parking Zones (Class IV Protected Bike Lane).
2. Source: National Association of City Transportation Officials, 2012 Second Edition, *Urban Bikeway Design Guide*, pages 45 to 47.
3. The above design guideline is a recommendation for complete streets implementation and does not supersede a jurisdiction's existing standards.
4. Refer to Illustrative Section for zone widths.

DESIGN GUIDELINE

Class IV Protected Bike Lane: Raised

Class IV Protected Bike Lanes provide exclusive use of bicycles, including separation in the form of physical barriers or grade separation, between the bicycle lane and vehicle lane.

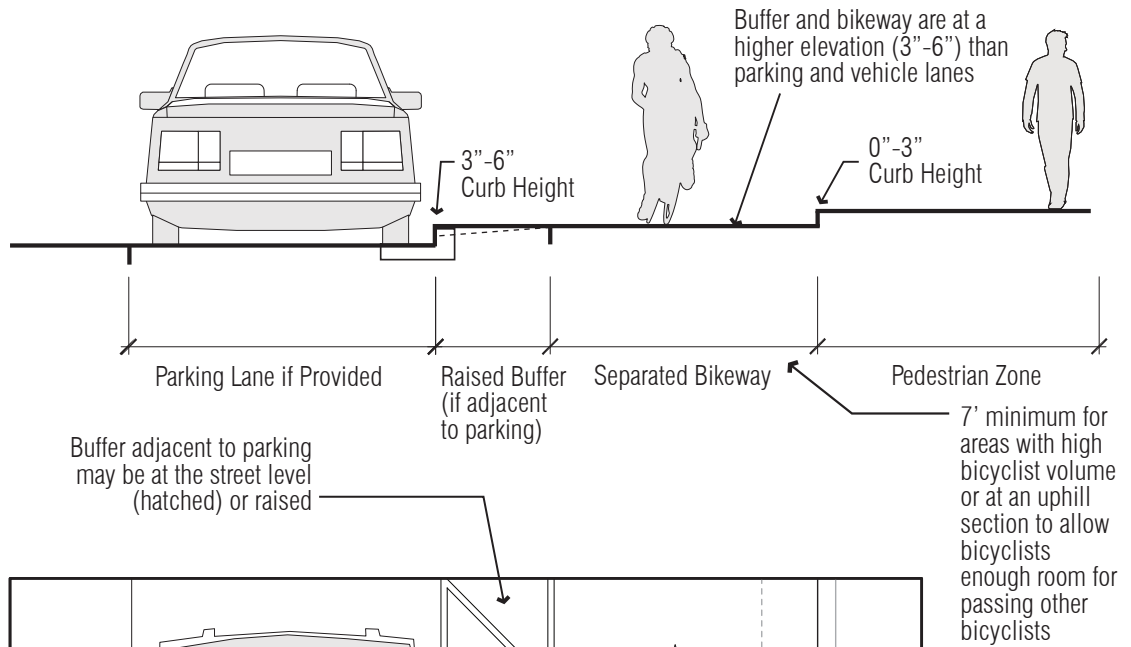

Class IV Protected Bike Lane pavement marking

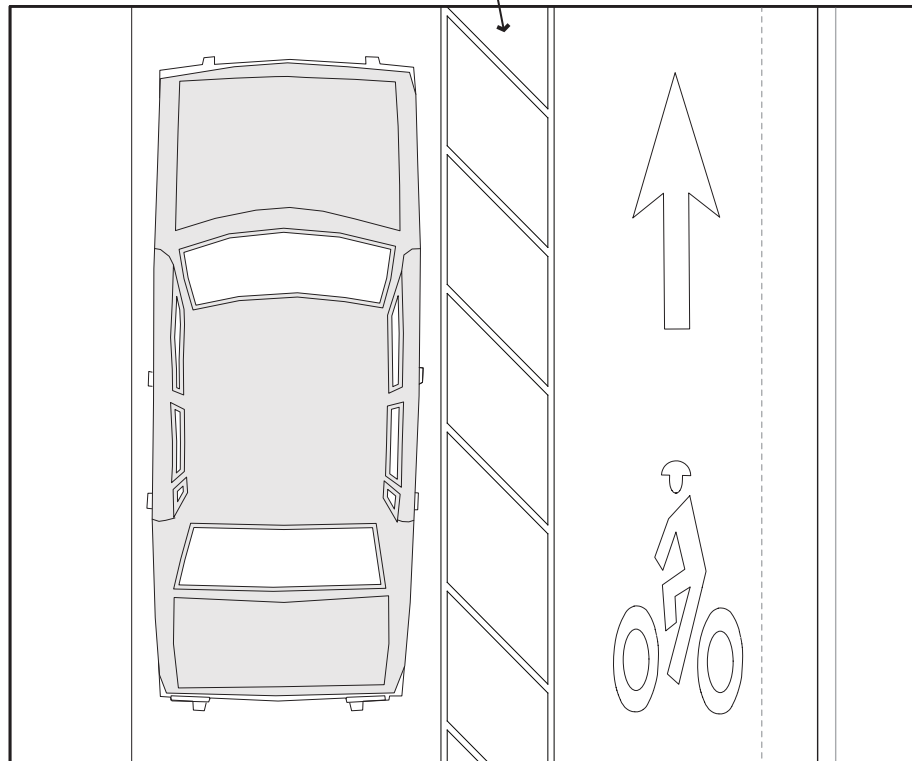

Notes:

1. The raised cycle track maybe at the same level as the sidewalk (typically 6") or it may be at an intermediate level (3").
2. If configured at a height flush with the sidewalk, then the cycle track should be separated and distinguished from the Pedestrian Zone through the use of pavement markings; different surface materials, textures or colors; landscaping; and/or furnishings in order to discourage pedestrian incursion into the Bicycle Zone.
3. All drainage should slope to the street. Drainage inlets should be in the adjacent travel or parking lane.
4. Mountable curb may be used if a need is foreseen for cyclists to transition from roadway to cycle track. If used, the mountable curb should have 4:1 slope with no seams or lips that might cause cyclists to fall when traversing the curb. This curb is not considered a rideable surface when determining cycle track width.
5. Sources: California Department of Transportation, December 2015, "Class IV Bikeway Guidance: Separate Bikeways/Cycle Tracks," Design Information Bulletin Number 89, pages 2 to 6; National Association of City Transportation Officials, 2012 Second Edition, *Urban Bikeway Design Guide*, pages 53 to 60; Federal Highway Administration, *Separated Bike Lane Planning And Design Guide*, May 2015.
6. The above design guideline is a recommendation for complete streets implementation and does not supersede a jurisdiction's existing standards.
7. Refer to Illustrative Section for zone widths.

DESIGN GUIDELINE

Class IV Protected Bike Lane: Off-Street

Class IV Protected Bike Lanes provide exclusive use of bicycles, including separation in the form of physical barriers or grade separation, between the bicycle lane and vehicle lane.

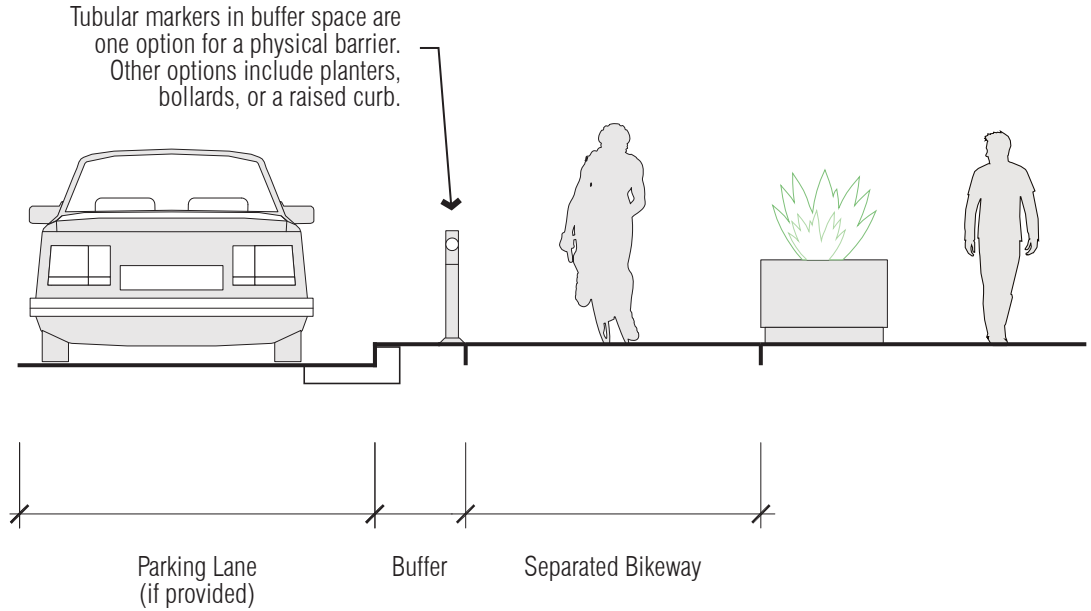

Class IV Protected Bike Lane adjacent to on-street parking

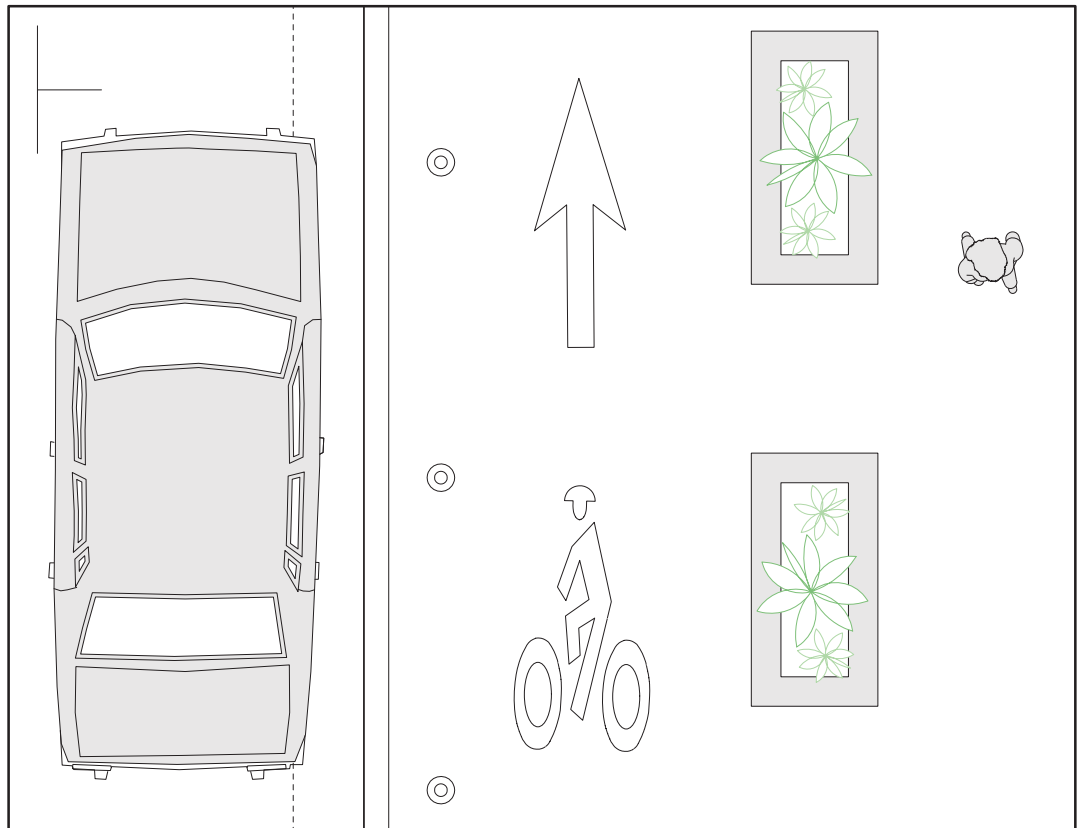

Notes:

1. It is recommended to provide a wider Bicycle Zone to include a buffer between the Bicycle and Vehicle Zones or between the Bicycle and Parking Zones (Class IV Protected Bike Lane).
2. National Association of City Transportation Officials, 2012 Second Edition, *Urban Bikeway Design Guide*, pages 45 to 47.
3. The above design guideline is a recommendation for complete streets implementation and does not supersede a jurisdiction's existing standards.
4. Refer to Street Type Illustrative Sections in Chapter 2 for zone widths.

DESIGN GUIDELINE

Class IV Protected Bike Lane: With Island Bus Platform

In-lane bus stops minimize bus delays caused from weaving with bikes and from waiting for a gap to pull back into traffic. Bus loading islands also increase comfort and reduce sideswipe collision risks for cyclists by eliminating the need to pass stopped buses.



Bus platform with bike lane adjacent to sidewalk
Source: NACTO.org

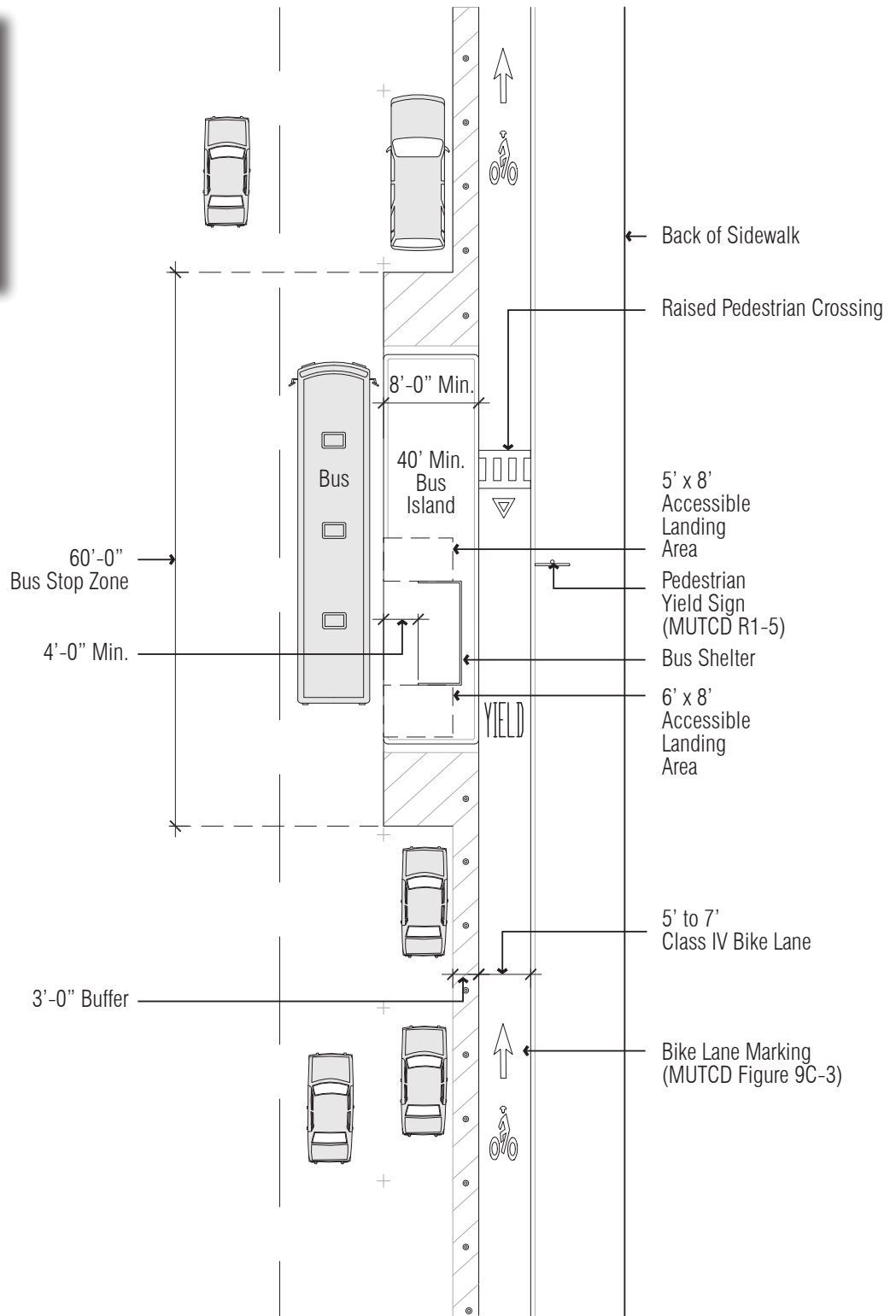

Notes:

1. It is recommended to provide a wider Bicycle Zone to include a buffer between the Bicycle and Vehicle Zones or between the Bicycle and Parking Zones (Class IV Protected Bike Lane).
2. Source: National Association of City Transportation Officials, 2012 Second Edition, *Urban Bikeway Design Guide*, pages 45 to 47.
3. The above design guideline is a recommendation for complete streets implementation and does not supersede a jurisdiction's existing standards.
4. Raised pedestrian crossing eliminates need for curb cuts and forces cyclists to slow before crossing where pedestrians have right of way.

DESIGN GUIDELINE
Bike Box

Bike boxes provide space for cyclists to queue where there are visible, reducing right-hook collision risks. Bike boxes also can reduce delays to right-turning vehicles by encouraging bikes to wait in a location that does not block turning movements.



Bike box pavement markings

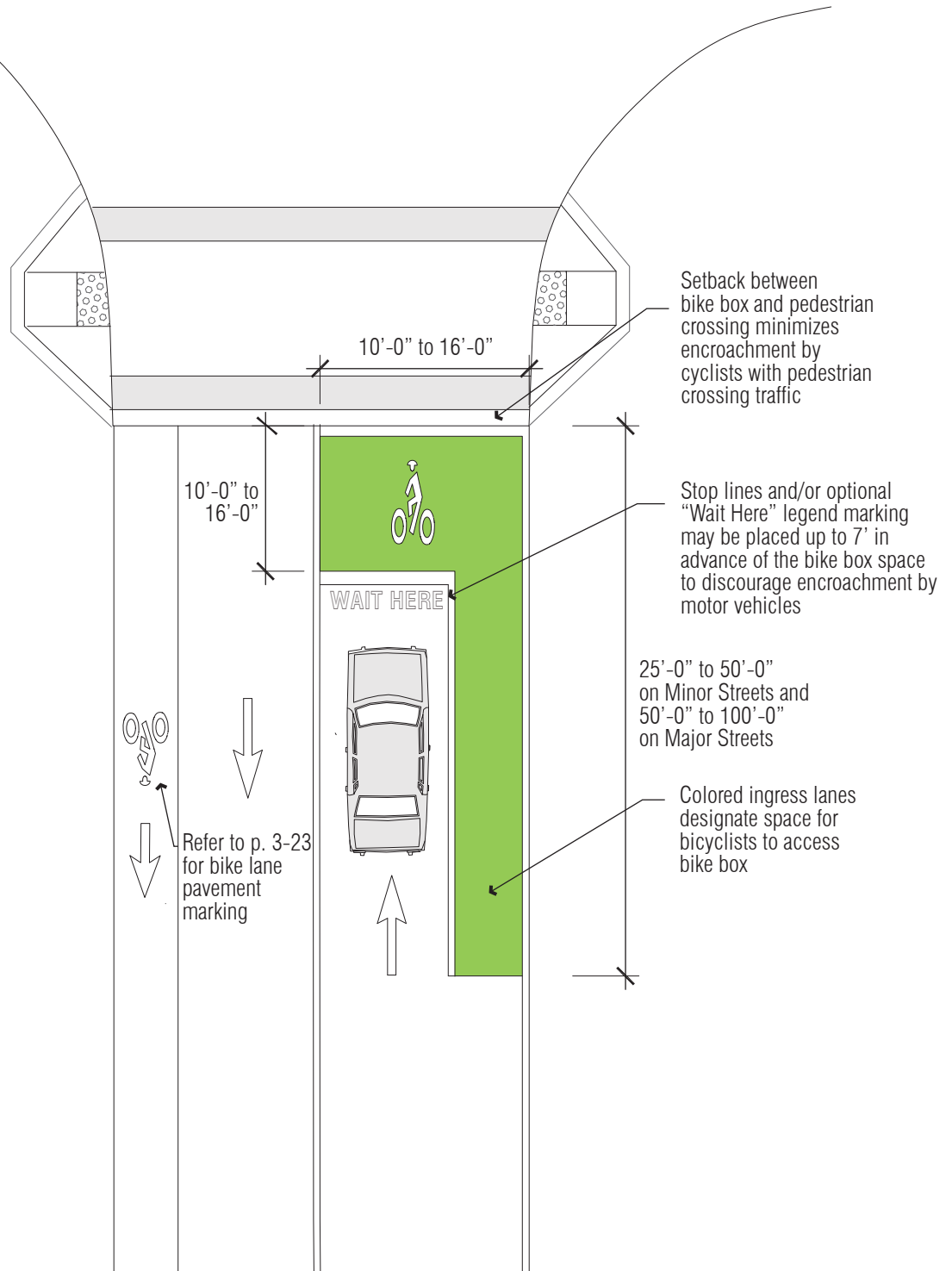

Notes:

1. Bike boxes should have colored pavement and be formed by transverse lines to provide space for queuing bicyclists at signalized intersection.
2. Deeper bike boxes minimize encroachment by vehicles.
3. It is recommended to provide bike boxes in an urban land use typology.
4. Source: National Association of City Transportation Officials, 2012 Second Edition, *Urban Bikeway Design Guide*, pages 71 to 73.
5. The above design guideline is a recommendation for complete streets implementation and does not supersede a jurisdiction's existing standards.

DESIGN GUIDELINE

Bike Detection at Actuated Traffic Signals

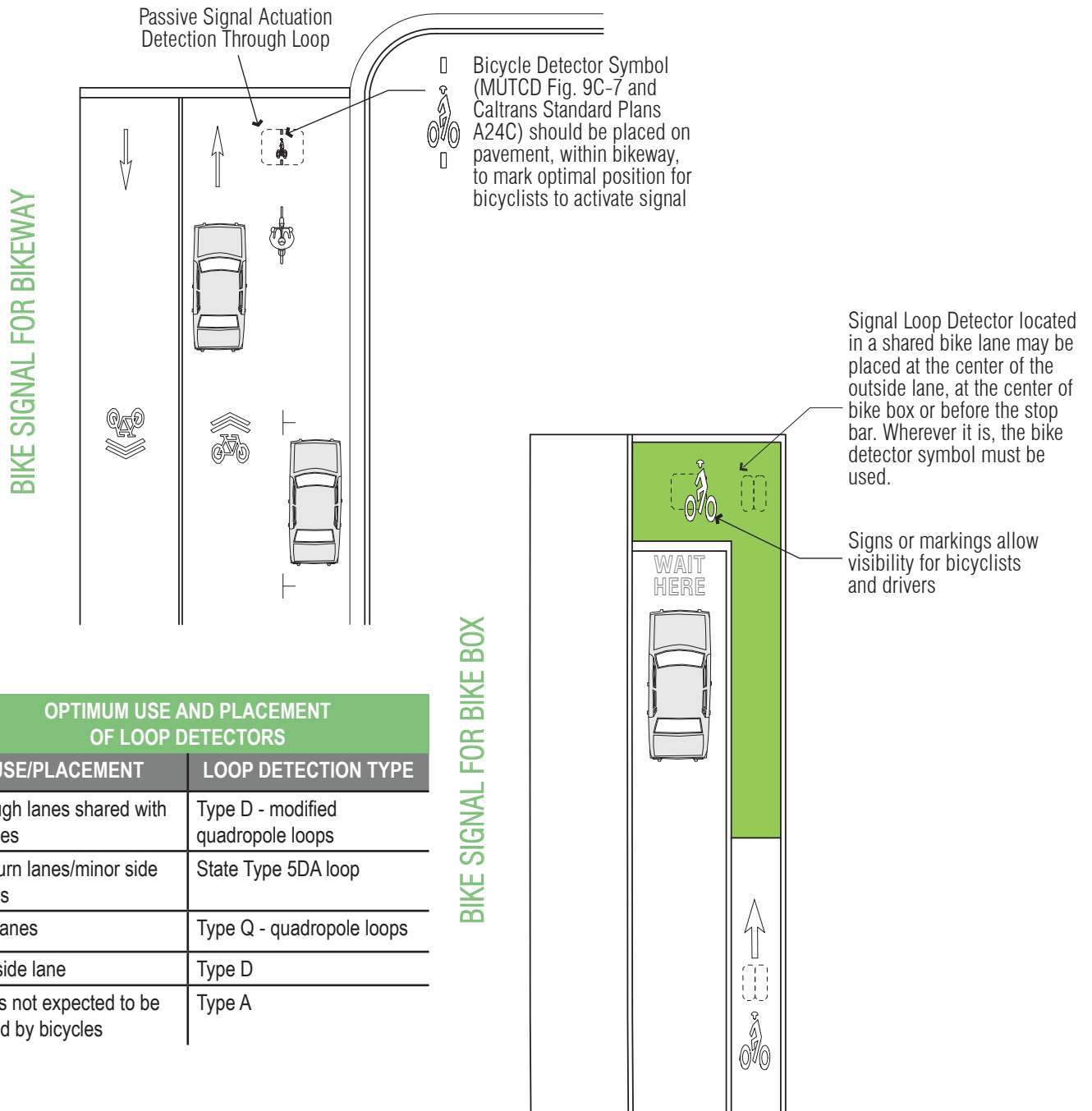

OPTIMUM USE AND PLACEMENT OF LOOP DETECTORS

USE/PLACEMENT	LOOP DETECTION TYPE
Through lanes shared with bicycles	Type D - modified quadropole loops
Left-turn lanes/minor side streets	State Type 5DA loop
Bike lanes	Type Q - quadropole loops
Curbside lane	Type D
Roads not expected to be shared by bicycles	Type A

Notes:

1. Per CVC 21450.5, all new and retrofitted traffic signals must detect bicycles on all approaches and movements or be placed on permanent recall or fixed time operation.
2. Detection at actuated traffic signals provides bicyclists the ability to trigger a traffic signal, rather than activating a pedestrian push button or illegally crossing a red light.
3. Bicycle detection can be provided with bicycle-sensitive loop detectors or video detection that prompt traffic signals to change. A bicycle detector symbol must be painted on the roadway to show bicyclists where they should be located to trigger the detection.
4. Source: National Association of City Transportation Officials, 2012 Second Edition, *Urban Bikeway Design Guide*, pages 163 to 171; CA MUTCD and 4D.105 (CA) and Figure 4D-111 (CA); Santa Clara Valley Transportation Authority Bicycle Technical Guidelines, 2012.
5. The above design guideline is a recommendation for complete streets implementation and does not supersede a jurisdiction's existing standards.

DESIGN GUIDELINE
Bike Racks and Lockers

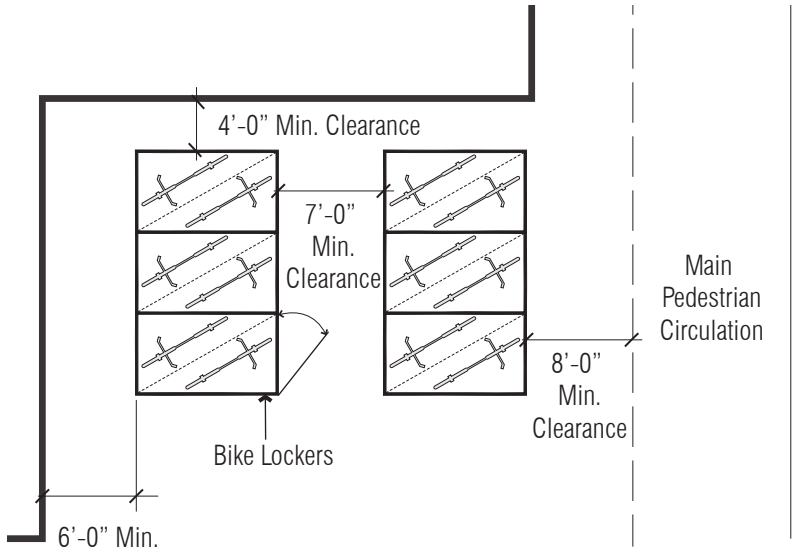

BIKE LOCKERS



Bike lockers



Examples of bike corrals

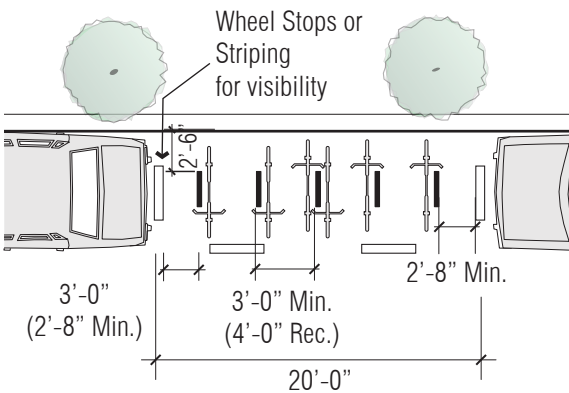

BIKE CORRAL

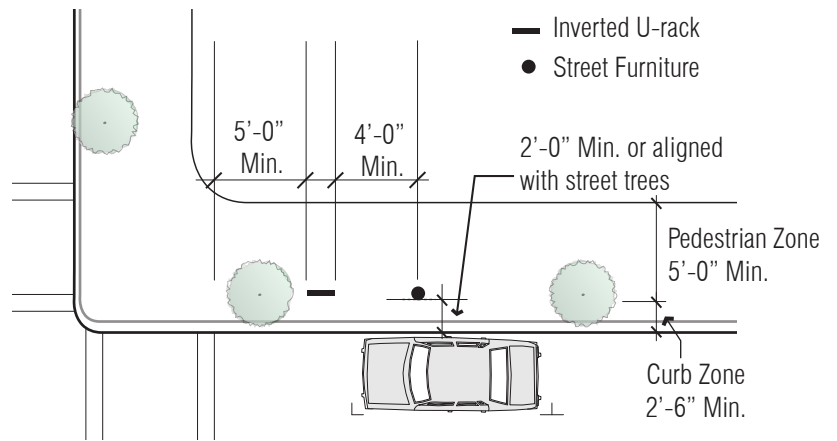

BIKE RACK SPACING RECOMMENDATIONS

Notes:

1. The above design guideline is a recommendation for complete streets implementation and does not supersede a jurisdiction's existing standards.



PARKING ZONE

DESIGN GUIDELINE
On-Street Parallel Parking

RECOMMENDED

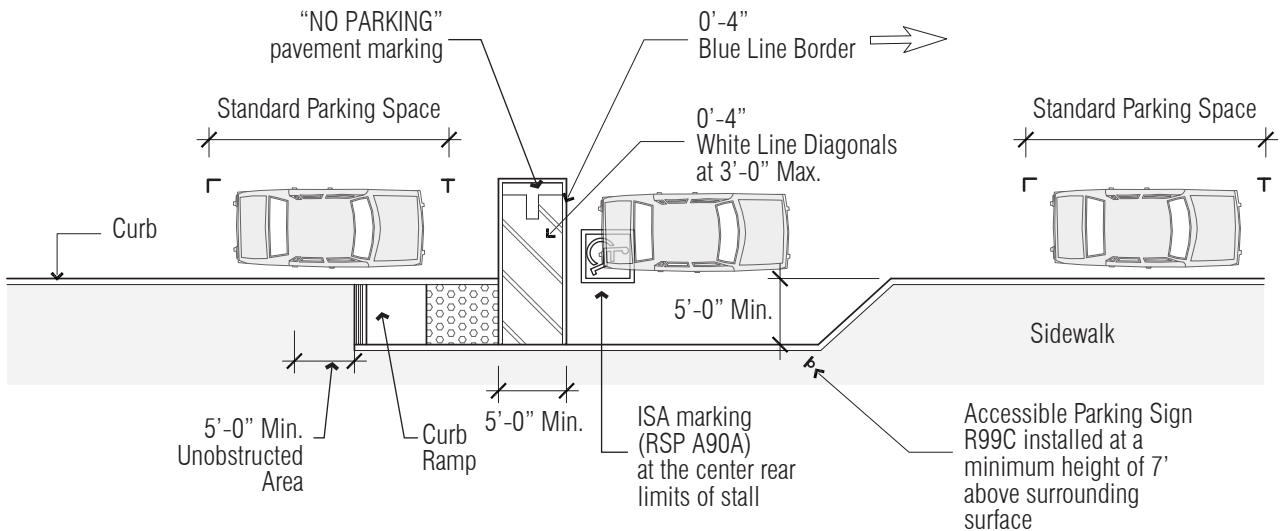

Parallel on-street parking, Berkeley, CA
Source: Google Earth

STANDARD

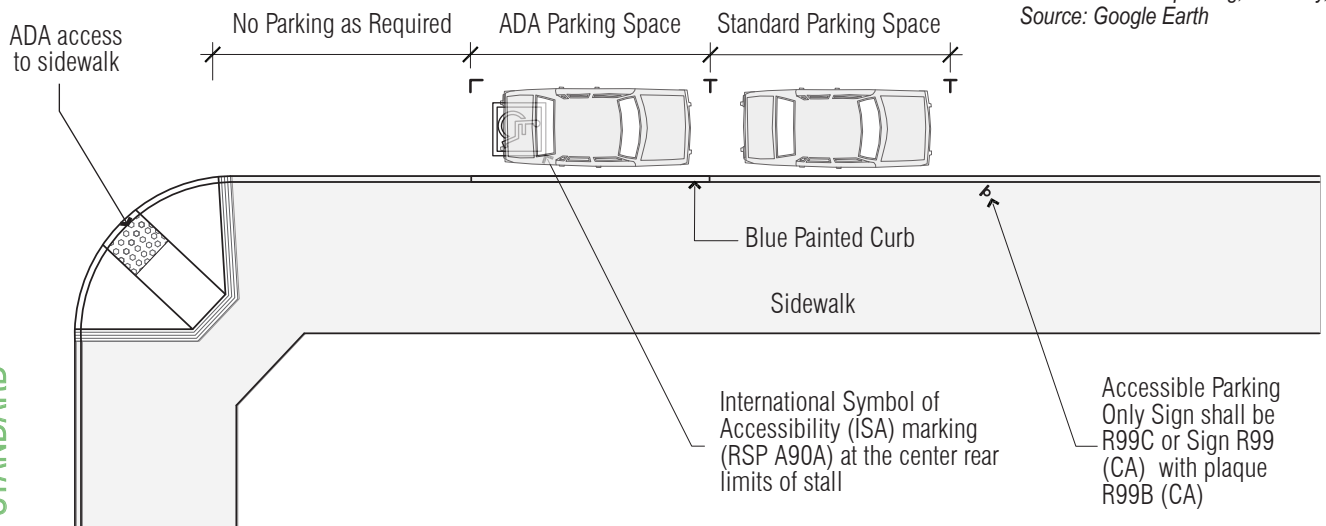

Notes:

1. Accommodate on-street parallel or diagonal parking to allow pedestrians convenient access to the adjacent Pedestrian Zone.
2. Preferred approach, but with limited sidewalk width and drainage constraints. Standard approach is acceptable near corners.
3. Source: State of California Department of Transportation, Accessible Parking On-Street, "Revised Standard Plan RSP A90B," http://www.dot.ca.gov/hq/esc/oe/project_plans/Errata/Errata-2006/2006_StdPln_Errata_No_10/rspa90b.pdf, accessed July 22, 2016.
4. The above design guideline is a recommendation for complete streets implementation and does not supersede a jurisdiction's existing standards.

DESIGN GUIDELINE
On-Street Angled Parking

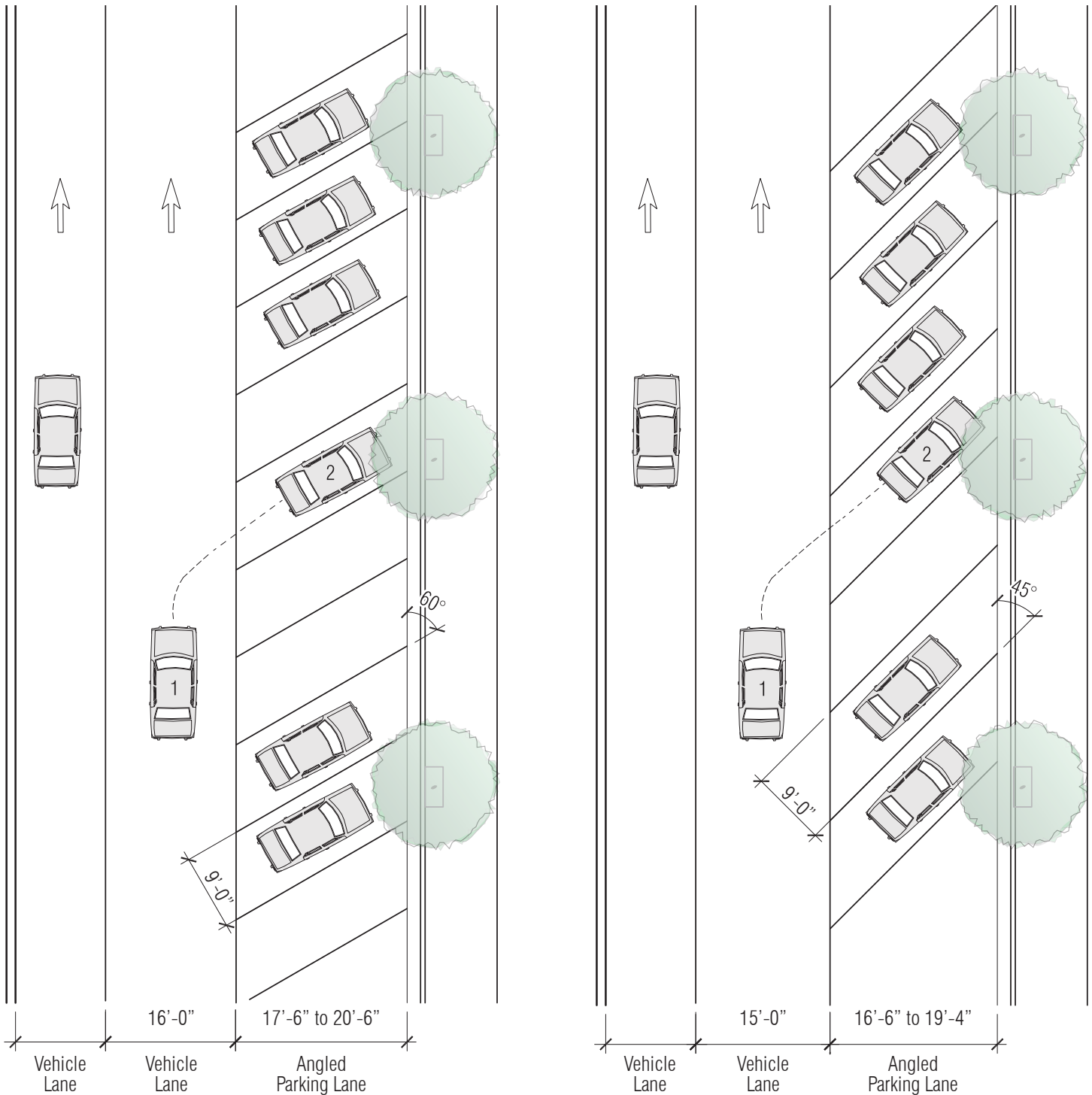

Notes:

1. Accommodate on-street parallel or diagonal parking to allow pedestrians convenient access to the adjacent Pedestrian Zone.
2. Sources: Federal Highway Administration (FHWA), 2006, FHWA University Course on Bicycle and Pedestrian Transportation, "Figure 15-7. Illustration. Changing from diagonal to parallel parking on a two-way street," <http://www.fhwa.dot.gov/publications/research/safety/pedbike/05085/chapt15.cfm>, accessed August 3, 2016; Gibbens, Michael P., *The CalDAG- California Disabled Accessibility Guidebook*, 2008, "General Requirements Parking," page 151.
3. The above design guideline is a recommendation for complete streets implementation and does not supersede a jurisdiction's existing standards.
4. Refer to Illustrative Section for vehicle lane widths.

VEHICLE ZONE



DESIGN GUIDELINE

Travel Lane Widths: By Modal Priority and Posted Speed Limit

RECOMMENDED TRAVEL LANE WIDTHS (feet) FOR ARTERIAL AND COLLECTOR STREETS Auto, Transit, or Truck Modal Priorities ^[1]			
POSTED SPEED LIMIT	25 mph	30 to 35 mph	> 40 mph
With Bike Lanes (Class II or Class IV Separated Bikeways)			
Curb Lane ^[2,3]	10 (auto priority) 12 (transit or truck priority)	10 to 11 (auto priority) 12 (transit or truck priority)	12 ^[6]
Other Travel Lanes (if more than one lane per direction)	10	10 to 11 (auto priority) 11 (transit or truck priority)	11
Without Bike Lanes (includes Class III Bikeway)			
Curb Lane ^[3, 4]	10 (auto priority) 12 (transit or truck priority)	15 ^[5]	12 ^[7]
Other Travel Lanes (if more than one lane per direction)	10	10 to 11 (auto priority) 11 (transit or truck priority)	11

RECOMMENDED TRAVEL LANE WIDTHS (feet) FOR ARTERIAL AND COLLECTOR STREETS Bicycle or Pedestrian Modal Priorities			
POSTED SPEED LIMIT	25 mph	30 to 35 mph	> 40 mph
With Bike Lanes (Class II or Class IV Separated Bikeways)			
All Travel Lanes	10	10	N/A ^[9]
Without Bike Lanes (includes Class III Bikeway)			
Curb Lane	10	10 to 15 ^[8]	N/A ^[9]
Other Travel Lanes (if more than one lane per direction)	10	10 to 11	N/A ^[9]

Notes:

- For transit and truck priority streets, the curb lane should be wider to account for larger vehicles, including mirrors.
- The suggested lane widths apply when the curb lane is a bus-only lane or queue jump.
- The suggested lane widths do not apply to Bus Rapid Transit (BRT), which may operate in either the inside or outside travel lane. Design parameters for BRT should account for faster bus speeds and greater passenger activity (boardings and alightings).
- Where the curb lane is a bus-only lane and the posted speed limit is 30 mph or less, the curb lane can be designated a shared bus/bike lane.
- If there is no Bicycle Zone and posted speed limits are 30 mph or greater, a wide curb lane may accommodate the passing of bicyclists within the lane.
- On streets with posted speed limits of 40 mph or greater, it is recommended to provide a buffer between the curb lane and bike lane. The 12' width assumes that there is also a minimum 2' buffer adjacent to the bike lane or that the bike facility is a Class IV Bikeway. See also table on page 3-19 on Bike Lane widths.
- Where posted speed limits are 40 mph or greater, a shared auto/bike lane is not recommended. Instead, any on-street bike accommodations should be either a Class II or Class IV Bike Lane.
- If there is no bicycle zone and posted speed limits are 30 to 35 mph, a wider curb lane may be used to accommodate the passing of bicyclists within the lane.
- Posted speed limits of 40 mph or greater are not recommended for pedestrian or bicycle priority streets.
- The lane widths indicated do not include the width of the gutter pan; the width of the curb lane is measured from the seam of the gutter pan and the paved roadway. Gutter pan widths typically vary from 12" to 24".
- If on-street parking is permitted, typically 7' to 8' is provided for a parallel parking lane. The width of the parking lane can include the width of the gutter pan (i.e., the parking lane width is measured from the curb face).
- Sources: American Association of State Highway and Transportation Officials (AASHTO), Chapter 4.3, *Green Book*; National Association of City Transportation Officials, *Urban Street Design Guide*; Caltrans, *Highway Design Manual*.

DESIGN GUIDELINE

Bus Facilities: Dedicated Bus-Only Lanes and Signal Priority



Dedicated bus lane

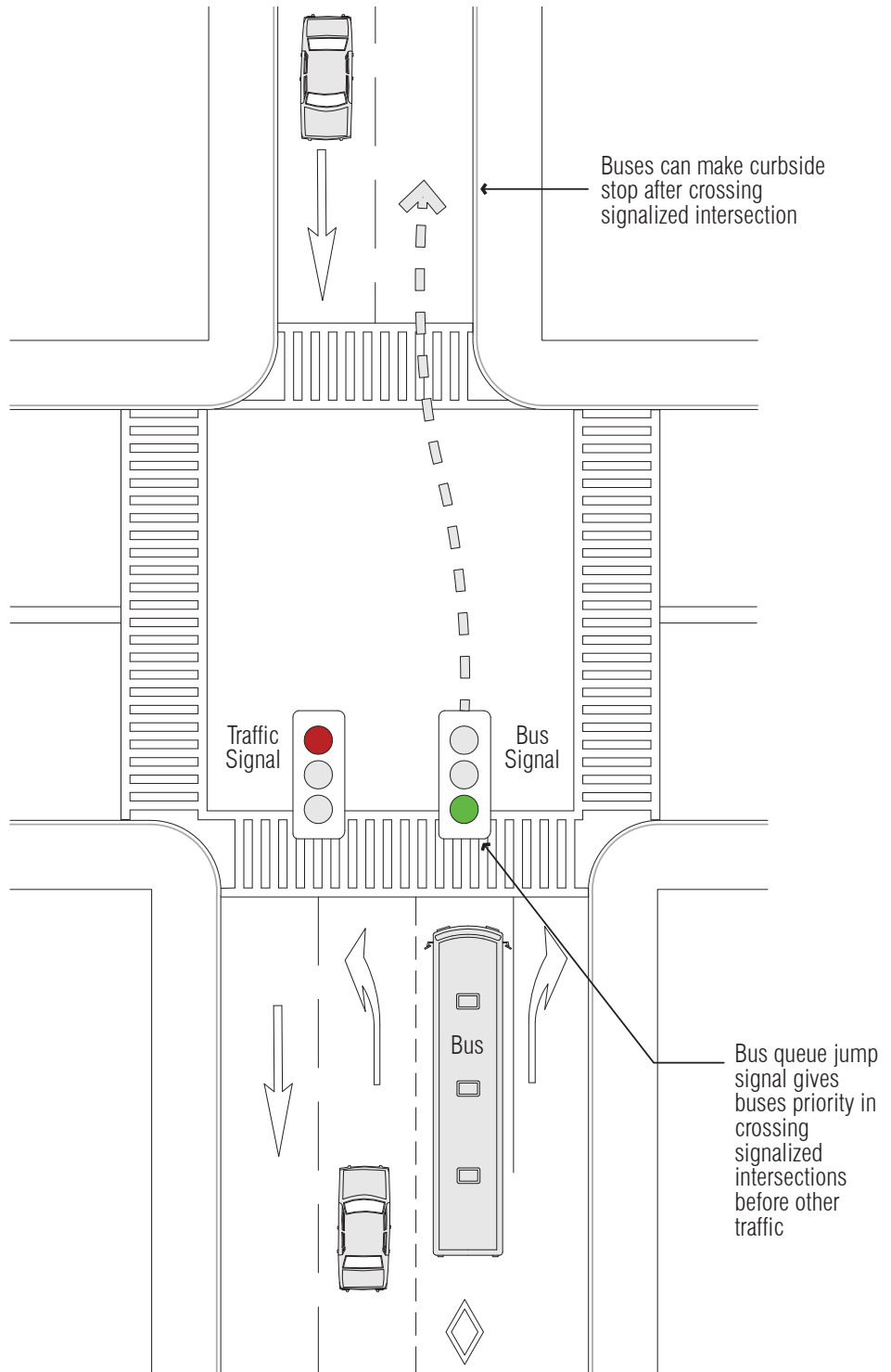

Notes:

1. Sources: National Association of City Transportation Officials, http://nacto.org/docs/usdg/effective_bus_only_lanes_kiesling.pdf, accessed August 3, 2016; Manual on Uniform Traffic Control Devices (MUTCD), 2009 Edition, "Part 3 Figure 3D-3. Markings for Contiguous Preferential Lanes," http://mutcd.fhwa.dot.gov/hm/2009/part3/fig3d_03_longdesc.htm, accessed August 3, 2016.
2. The above design guideline is a recommendation for complete streets implementation and does not supersede a jurisdiction's existing standards.

DESIGN GUIDELINE
Shared Streets

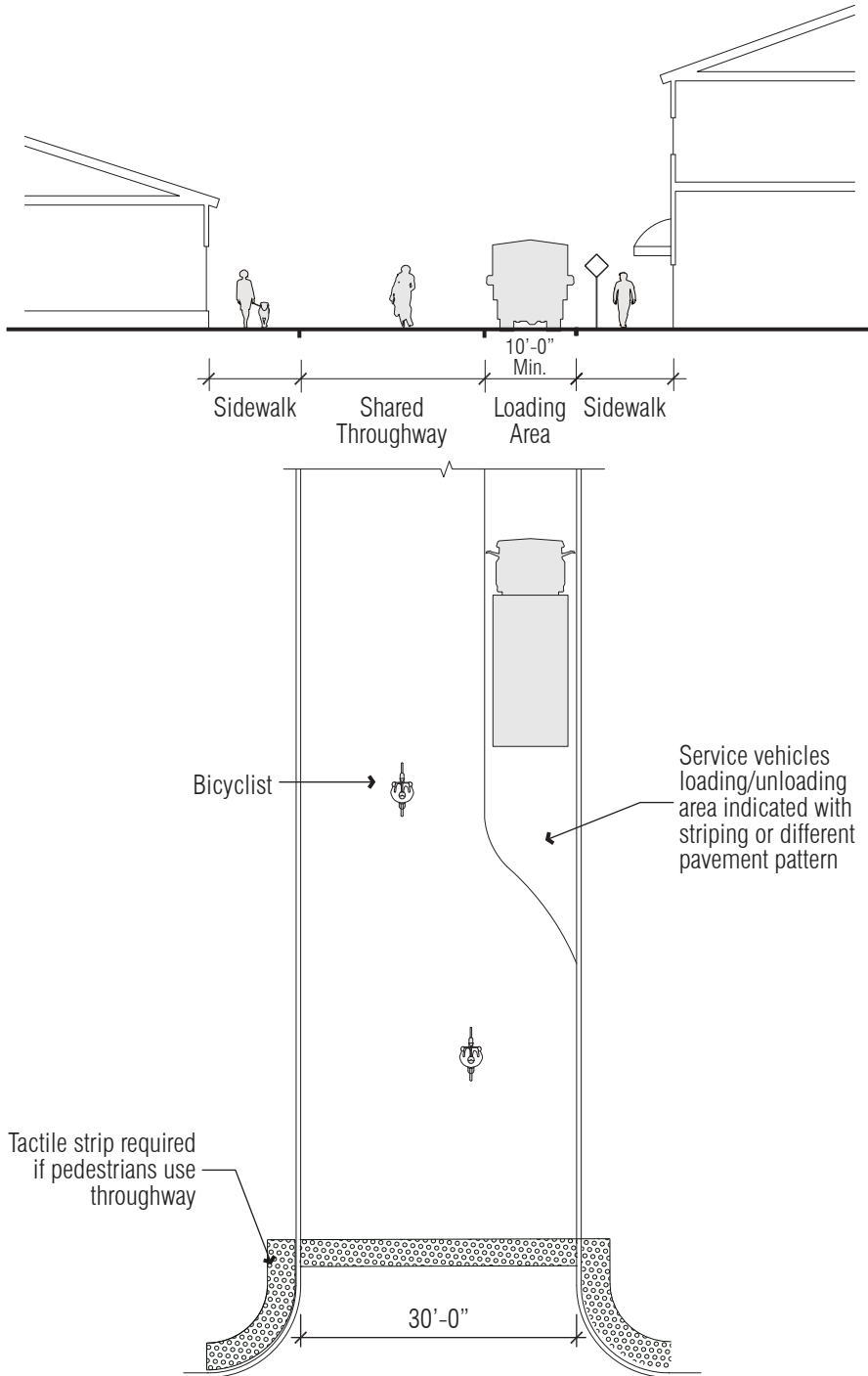

Shared throughway at Bell Street in Seattle, WA showing unloading/loading area for service vehicles



Shared throughway at Bell Street in Seattle, WA



Example of at-grade crossing at shared street intersection, in Seattle, WA

Notes:

1. Consider implementing shared streets with slow vehicle and bicycle traffic.
2. Service Parking areas allow service vehicles and should be indicated with different paving or striping.
3. Source: National Association of City Transportation Officials (NACTO), 2012 Second Edition, *Urban Street Design Guide*, pages 28 to 29; NACTO, "Commercial Shared Street," *Urban Street Design Guide*, <http://nacto.org/publication/urban-street-design-guide/streets/commercial-shared-street>, accessed August 3, 2016.
4. The above design guideline is a recommendation for complete streets implementation and does not supersede a jurisdiction's existing standards.

A photograph of a city street median zone. The median is a grassy strip between two lanes of traffic, planted with large green plants and purple flowers. A green rectangular overlay with the text "MEDIAN ZONE" in white capital letters is centered over the image. In the background, there are trees, a white bus with the number 2731, and a building with a pointed roof. The sky is clear and blue.

MEDIAN ZONE

DESIGN GUIDELINE

Median Landscaping

Per Water Efficiency Landscape Ordinance, no irrigation spray shall be used within 2 feet of impermeable surface.

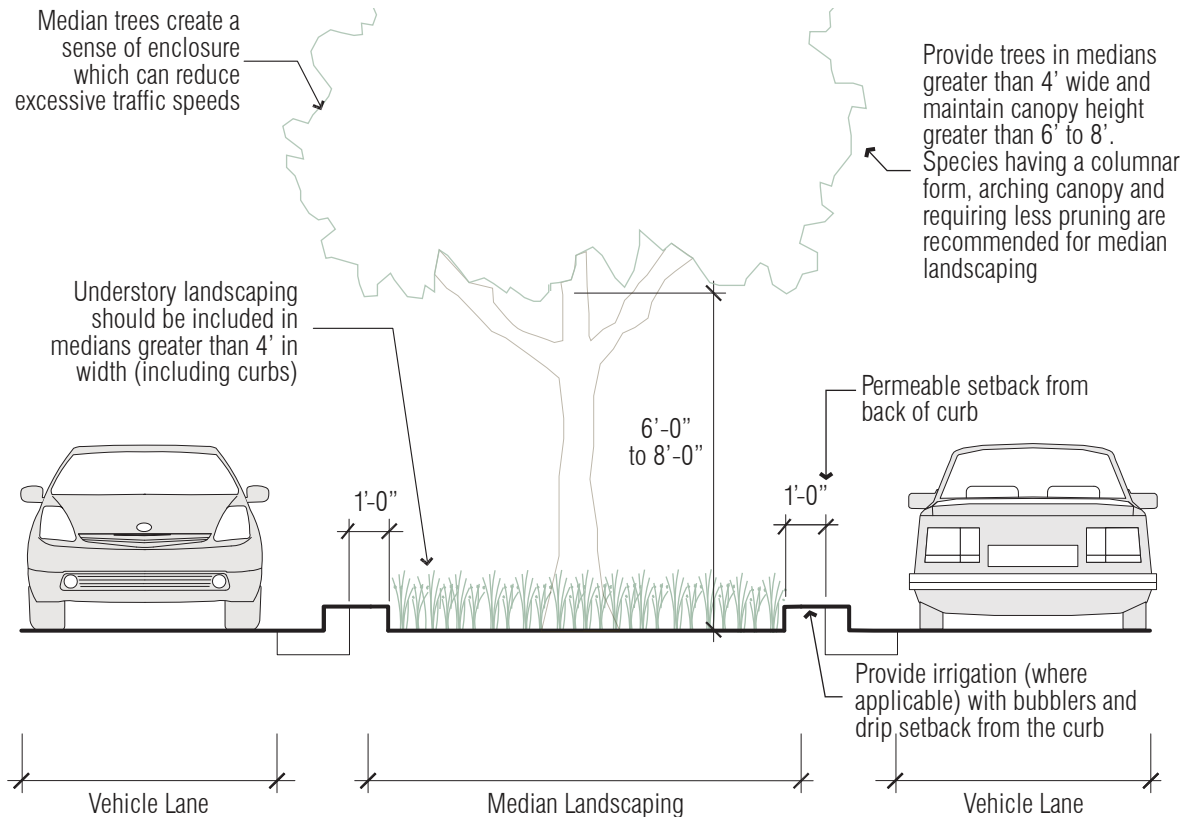

Notes:

1. Trees should not be planted within 25' of an intersection.
2. Trees should be pruned to maintain 14' clearance from the lowest branch, within 50' of an intersection.
3. Spacing of trees may vary from 15' on center to 35' on center, depending on the expected size of the tree at maturity. Small trees (< 20' crown diameter) at 15' on center, medium size tree (20' to 35' crown diameter) at 25' on center, and tall trees (> 35' crown diameter) at 35' on center.
4. Consider incorporating landscaping standards, including green infrastructure/stormwater requirements, for vegetation in the median zone.
5. Source: City and County of San Francisco, 2011, Chapter 6.1: Urban Forest, *Better Streets Plan*, pages 165 to 167.
6. The above design guideline is a recommendation for complete streets implementation and does not supersede a jurisdiction's existing standards.

DESIGN GUIDELINE
Pedestrian Refuge Island

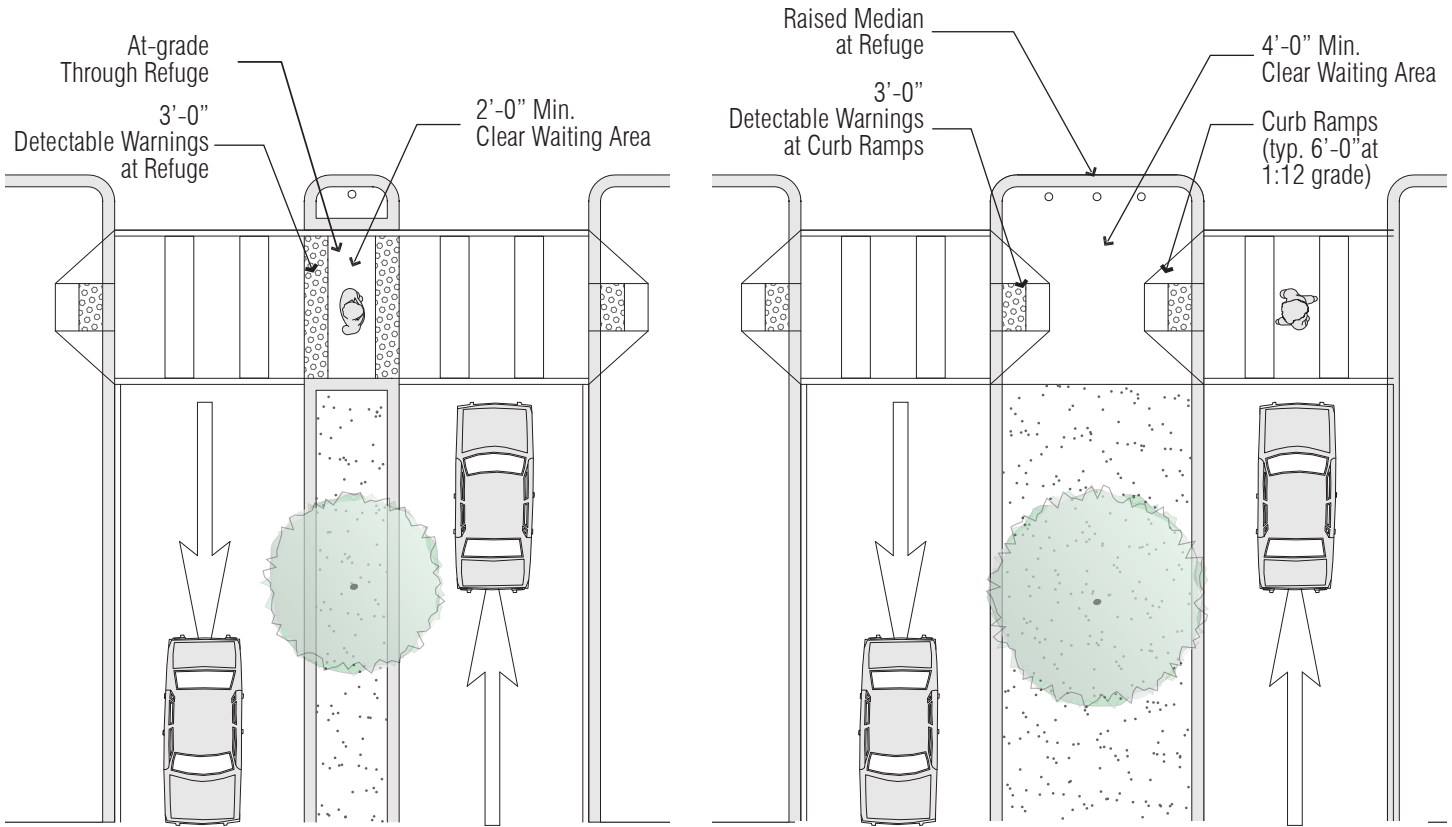

**PEDESTRIAN REFUGE ISLAND
6'-0" TO 16'-0" WIDE**

**PEDESTRIAN REFUGE ISLAND
MORE THAN 16'-0" WIDE**

Pedestrian refuge island with detectable warnings at intersection



Raised median at refuge with clear waiting area for pedestrians crossing the street

Notes:

1. Source: City and County of San Francisco, SF Better Streets, "Medians and Islands," <http://www.sfbetterstreets.org/find-project-types/pedestrian-safety-and-traffic-calming/traffic-calming-overview/medians-and-islands>, accessed August 3, 2016.
2. The above design guideline is a recommendation for complete streets implementation and does not supersede a jurisdiction's existing standards.
3. Median nose provides protection for pedestrians and forces motorists to take turns at slower speed.
4. Pedestrian refuge island width of 6 feet or greater is recommended to provide enough width for parents pushing strollers and cyclists walking bikes.

A photograph of a street intersection. In the foreground, there is a crosswalk with white stripes on a dark asphalt road. A green rectangular box with the text "CROSSING ZONE" in white capital letters is overlaid on the image. In the background, a green bus is driving across the intersection, followed by several white cars. To the left, there is a Chevron gas station. In the distance, a large billboard for Universal Orlando's Islands of Adventure is visible, featuring the text "SWING HIGHER" and "UNIVERSAL ORLANDO". The sky is clear and blue.

CROSSING ZONE

DESIGN GUIDELINE Crosswalks

Higher visibility crosswalks improve yielding compliance because the crosswalk is better aligned with a motorist's eye height.



Continental marked crosswalk



Marked crosswalk using different pavement materials

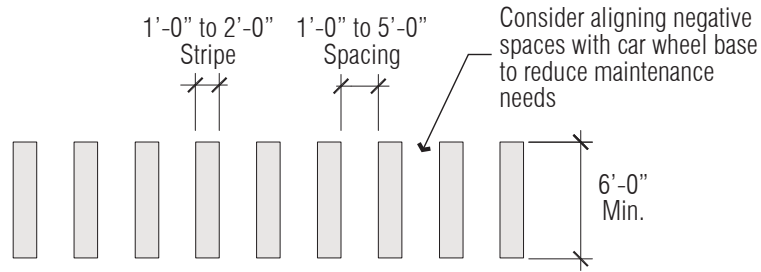

CONTINENTAL MARKED CROSSWALK

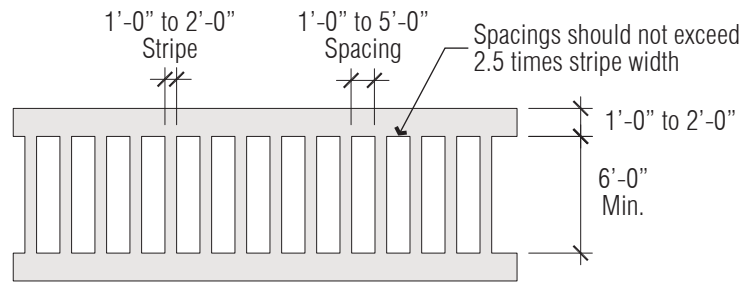

LADDER MARKED CROSSWALK

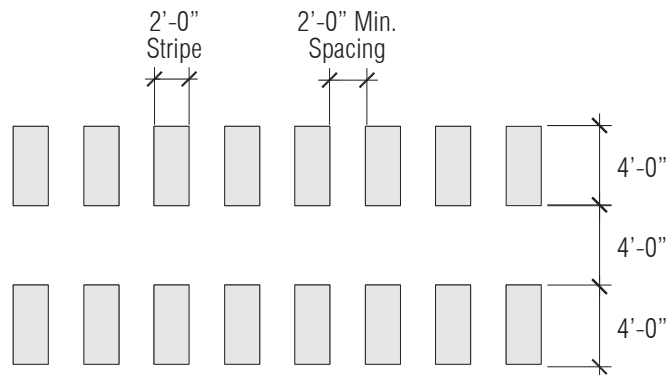

TRIPLE-FOUR MARKED CROSSWALK

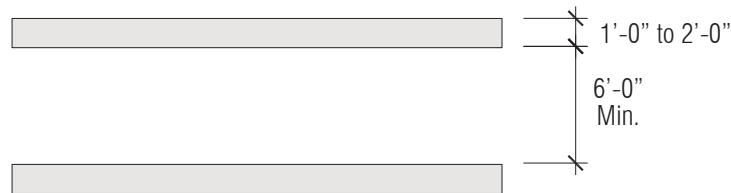

STANDARD MARKED CROSSWALK

Notes:

1. Source: State of California Department of Transportation, 2012, Pavement Markings Crosswalks, Revised Standard Plan RSP A24F, <http://www.fhwa.dot.gov/publications/research/safety/04100/04100.pdf>, accessed July 29, 2016.
2. The unstriped portion of a Triple-Four Marked Crosswalk should provide a space that is not a slipping risk when wet. Consider retroreflectivity, slipping or surface roughness, and application/material selection for durability.
3. The above design guideline is a recommendation for complete streets implementation and does not supersede a jurisdiction's existing standards.

DESIGN GUIDELINE Corner Treatment

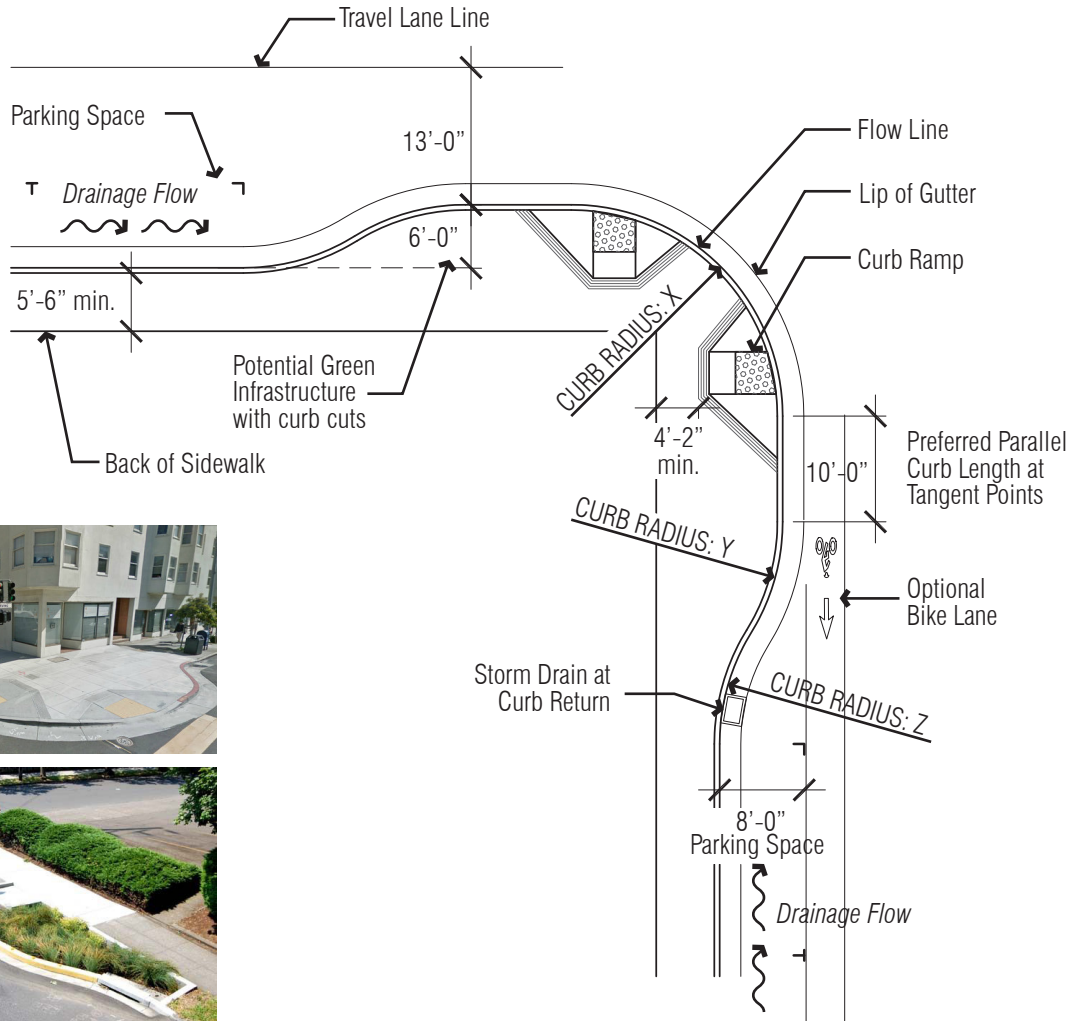

Examples of bulb-outs

ARTERIAL AND COLLECTOR STREETS

MODAL PRIORITY	CURB RADIUS (feet)		
	X	Y	Z
AUTO	20	5	10
BICYCLE	12	5	10
PEDESTRIAN	10	10	10
TRANSIT	30	10	10
TRUCKS	30	10	10

LOCAL STREET

LAND USE TYPOLOGY	CURB RADIUS (feet)		
	X	Y	Z
URBAN	10	5	10
SUBURBAN	5	5	5
RURAL AND OPEN SPACE	12	5	5
INDUSTRIAL	20	5	10

Notes:

1. The above design guideline is a recommendation for complete streets implementation and does not supersede a jurisdiction's existing standards.
2. Green infrastructure should be located to receive water. Curb radius should consider fire truck turning; radius must either allow trucks to stay off the sidewalk or the portion of the sidewalk where they encroach must be clear of obstructions.

DESIGN GUIDELINE
Protected Intersection



Protected intersection with colored pavement

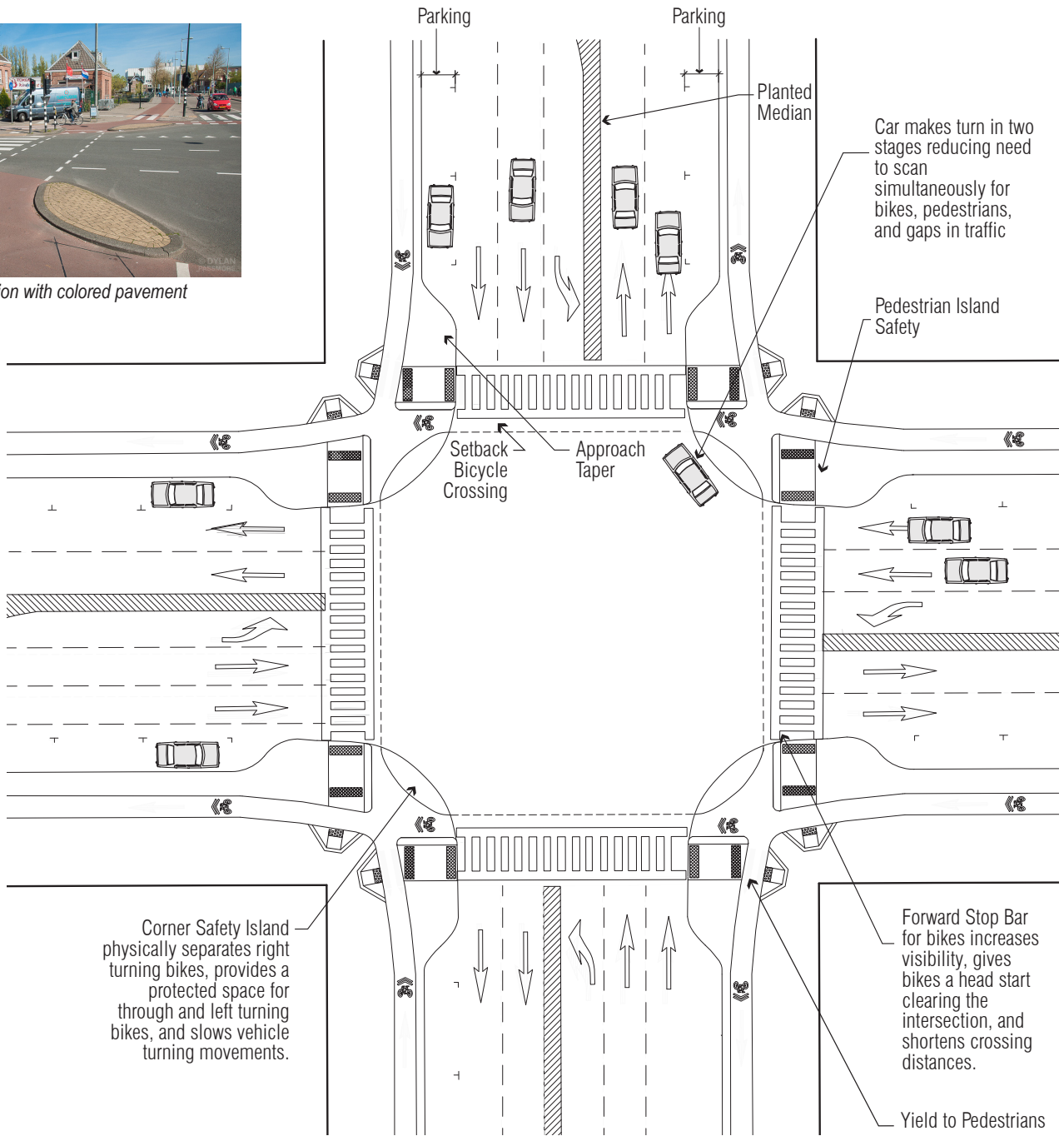

Notes:

1. Source: California Department of Transportation, December 2015, "Class IV Bikeway Guidance: Separated Bikeways/Cycle Tracks," Design Information Bulletin Number 89, page 7.
2. The above design guideline is a recommendation for complete streets implementation and does not supersede a jurisdiction's existing standards.

DESIGN GUIDELINE

Crosswalk Dual Ramps

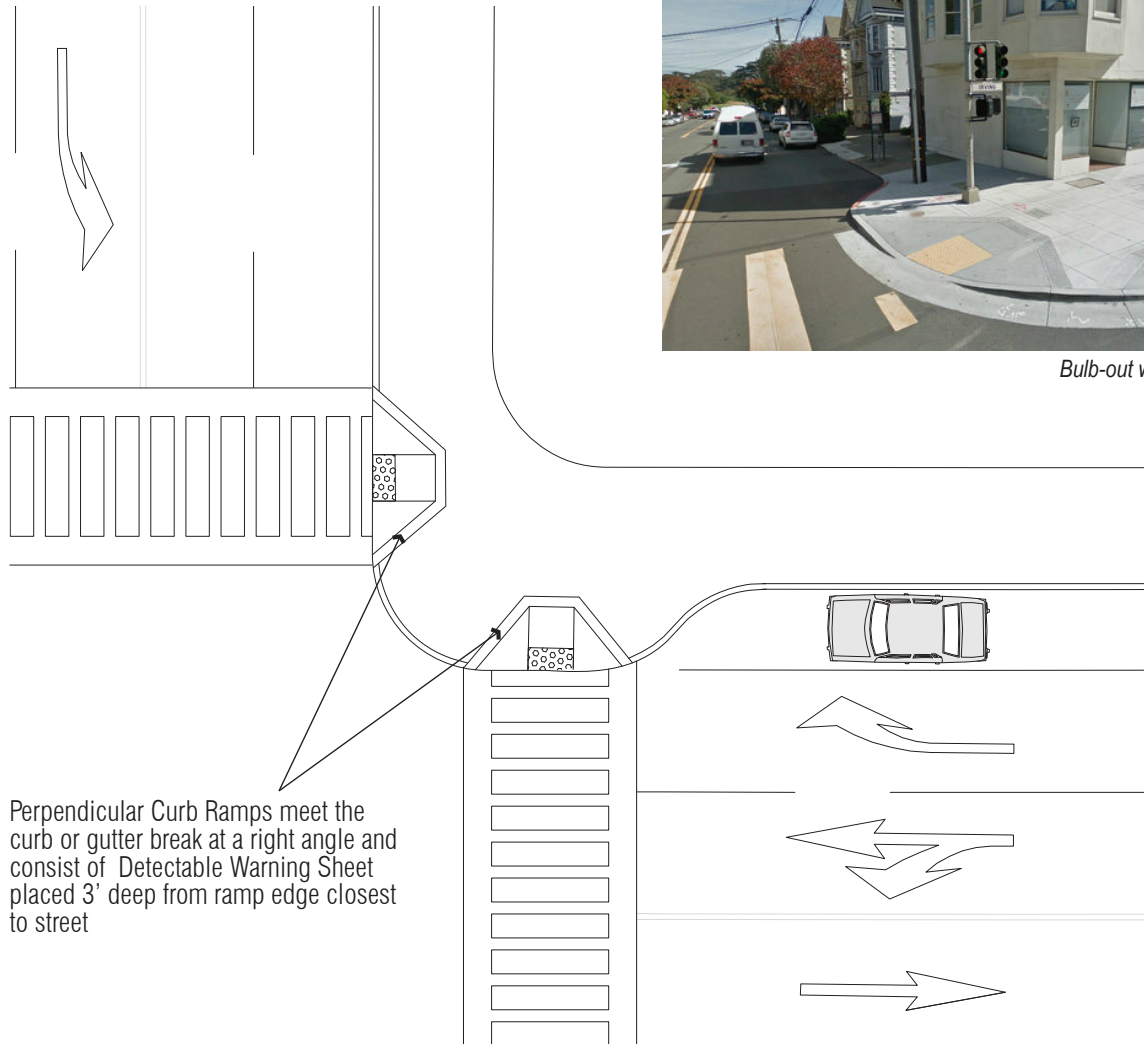

Bulb-out with crosswalk dual ramps
Source: SF Streets Blog

Notes:

1. Truncated domes in the detectable warning surface should be aligned in a square or radial pattern and comply with R304 of ADA guidelines. Surface tile is cast-in-place and has a thickness of 0.25", with standard sizes of 24"x36", 24"x48", 24"x60", 36"x48", and 36"x60". A typical 24"x36" tile has dome spacing of 1.67".
2. Detectable warning surfaces should contrast in color with the adjacent street or walkway surface to help pedestrians with mobility or vision impairments to locate the curb ramp from the other side of the street. The surface color could be either light-on-dark or vice versa, and may provide for full ramp surface except for the flared sides of the ramp.
3. Perpendicular ramps can be provided where sidewalk width is at least 12' wide and has minimum 4'-2" clear space on top of the ramp to allow adequate space for pedestrians to walk. If distance from the curb to sidewalk is limited, corner-type or diagonal curb ramp may be provided with a minimum of 4'-2" clear space at the end of the ramp located within the marked crosswalk, to ensure safety of pedestrians from vehicular traffic.
4. Source: City and County of San Francisco, *Better Streets Plan*, 2011, Chapter 5: Street Designs, pages 165 to 167; United States Access Board, <https://www.access-board.gov/guidelines-and-standards/streets-sidewalks/public-rights-of-way/proposed-rights-of-way-guidelines/chapter-r3-technical-requirements>, Accessed September 26, 2016; Americans with Disabilities Act Guidelines, <http://www.detectable-warning.com/guidelines.shtml>, Accessed September 26, 2016; California Department of Transportation, http://www.dot.ca.gov/hq/esc/oe/project_plans/highway_plans/2010-RSP-and-NSP/rspa88a.pdf, Accessed September 26, 2016.
5. The above design guideline is a recommendation for complete streets implementation and does not supersede a jurisdiction's existing standards.

DESIGN GUIDELINE
Mid-block Crossing

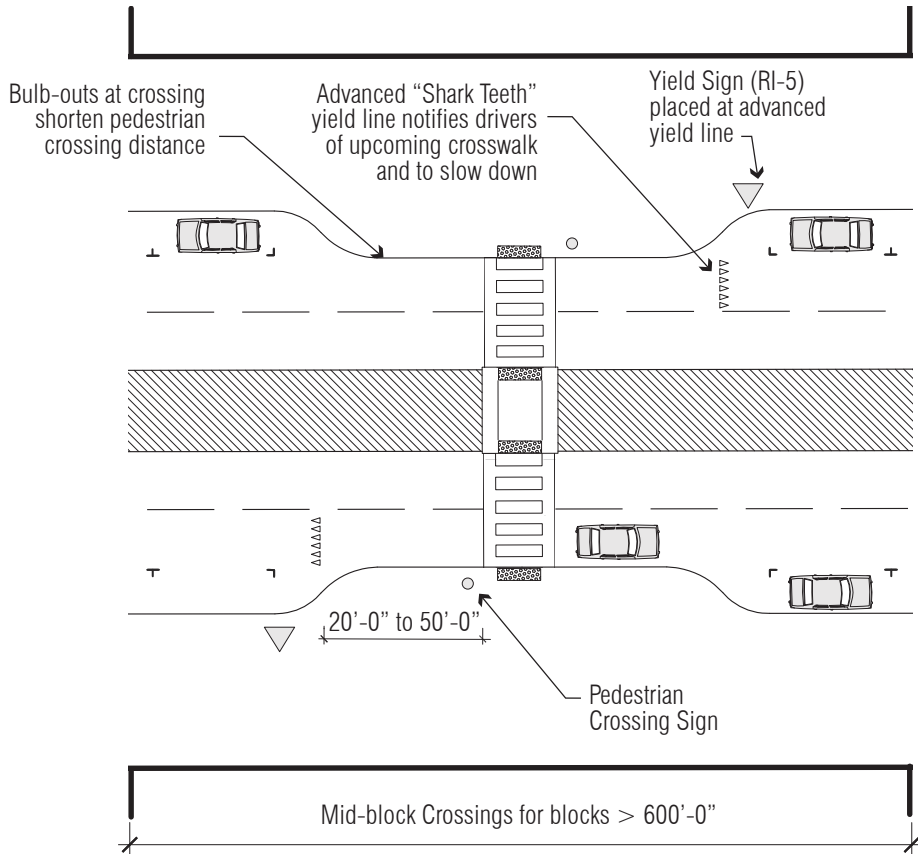

Advanced "shark teeth" yield line

OTHER TRAFFIC CONTROL DEVICES¹

	<p>Rectangular rapid flashing beacon (RRFB)</p>
	<p>In-roadway warning lights</p> <p>Source: FHWA DOT</p>
	<p>Pedestrian hybrid beacon (PHB)</p>

STANDARD WARNING SIGNS

<p>Place Pedestrian Crossing sign at mid-block crossing</p>	<p>Place Advance Pedestrian Crossing sign 100 feet in advance of intersection</p>	<p>Place R1-5 or R1-5a at YIELD line</p>

Source: Trafficsign.us

Notes:

1. Traffic control devices are mutually exclusive. Do not use traffic control devices with yield or stop signs.
2. On-street parking should be prohibited in area between yield lines and crosswalk.
3. Sources: CA MUTCD Section 4F Pedestrian Hybrid Beacons, Section 4N In-roadway lights; Federal Highway Administration (FHWA), Pedestrian Hybrid Beacon Guide - Recommendations and Case Study, http://safety.fhwa.dot.gov/ped_bike/tools_solve/fhwasa14014, accessed September 28, 2016; American Association of State Highway and Transportation Officials (AASHTO), 2004, *Guide for the Planning, Design, and Operation of Pedestrian Facilities*; National Association of City Transportation Officials, Urban Street Design Guide, <http://nacto.org/publication/urban-street-design-guide/intersection-design-elements/crosswalks-and-crossings/midblock-crosswalk>, accessed September 29, 2016; FHWA Designing Sidewalks and Trails for Access Part II of II: Best Practices Design Guide Chapter 8; FHWA, 2008, Interim Approval for Option Use of Rectangular Rapid Flashing Beacons (IA-11); FHWA, 2006, Federal Highway Administration University Course on Bicycle and Pedestrian Transportation Lesson 12: Midblock Crossings.
4. The above design guideline is a recommendation for complete streets implementation and does not supersede a jurisdiction's existing standards.

DESIGN GUIDELINE
Daylighting Intersections

CONDITION	DAYLIGHTING GUIDANCE
Urban streets with 20 to 30 mph speed limits	Keep at least 20 feet clear (removal of one parking space) in advance of crosswalks at each intersection approach
Streets with 35 to 45 mph speed limits	Keep at least 50 feet clear (removal of two parking spaces) in advance of crosswalks at each intersection approach

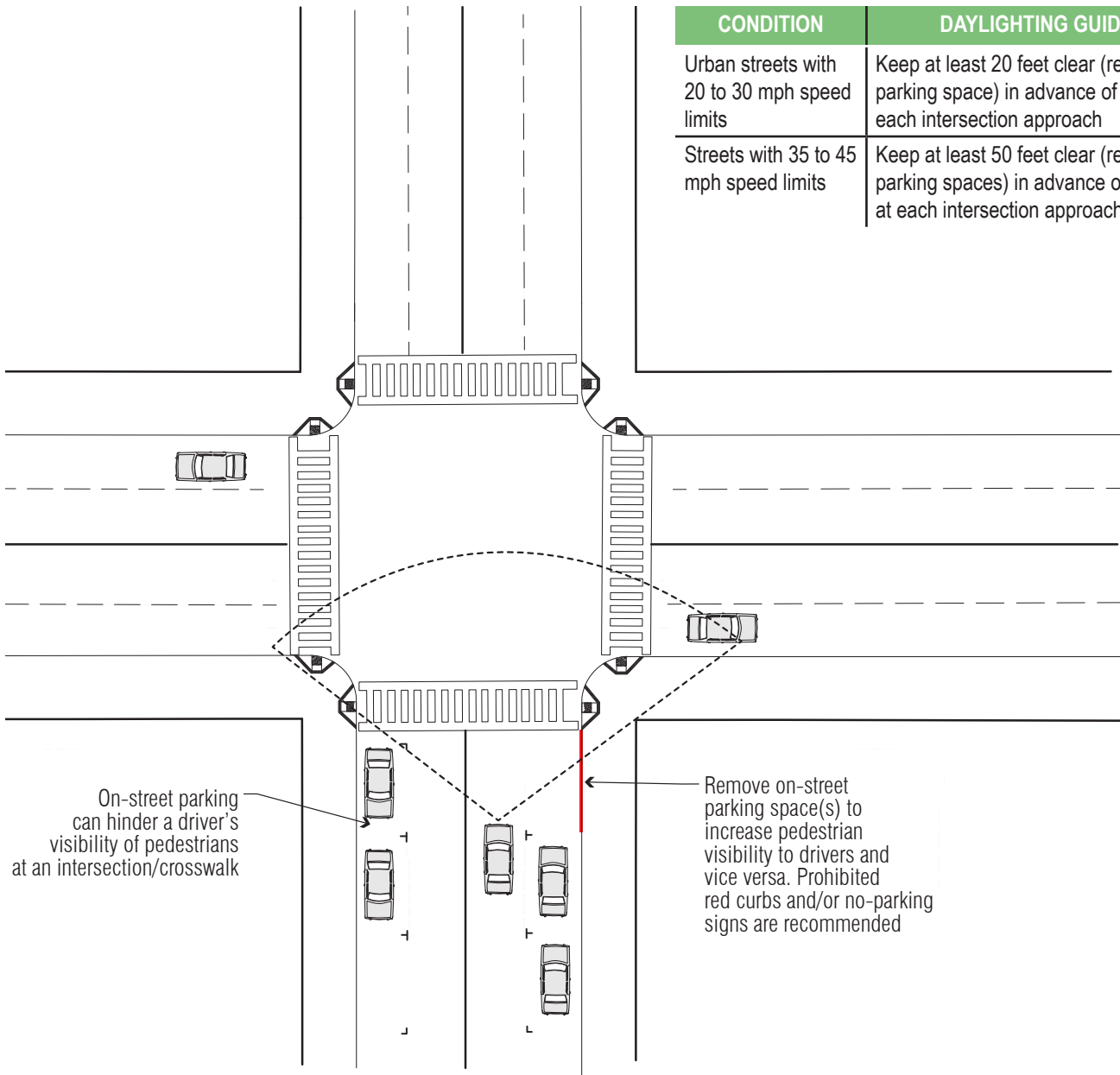

Notes:

1. Daylighting can also be used at driveways and other poor sightline areas.
2. Daylighting can provide space for other uses such as green infrastructure, landscaping, bike parking, curb extensions, parklets, and Painted Safety Zones.
3. Sources: National Association of City Transportation Officials, Urban Street Design Guide, <http://nacto.org/publication/urban-street-design-guide/intersection-design-elements/visibility-sight-distance>, accessed September 27, 2016; America Walks, Daylighting, <http://americawalks.org/daylighting>, accessed September 27, 2016; San Francisco Municipal Transportation Agency Blog, March 2015, "Daylighting' Makes San Francisco Crosswalks Safer", accessed September 27, 2016.
4. The above design guideline is a recommendation for complete streets implementation and does not supersede a jurisdiction's existing standards.

DESIGN GUIDELINE
Painted Safety Zone

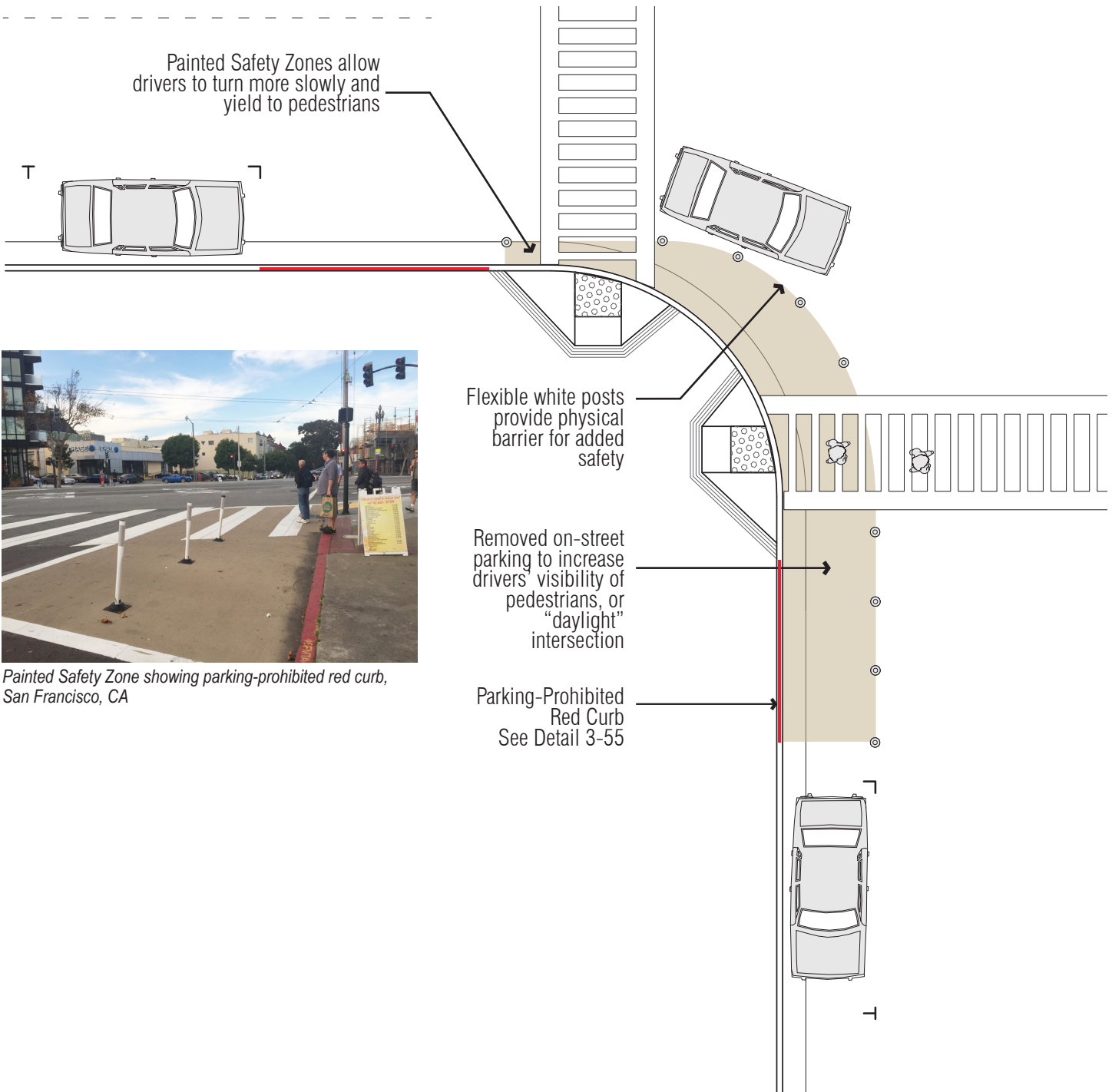

Painted Safety Zone showing parking-prohibited red curb, San Francisco, CA

Notes:

1. Painted Safety Zones act as a low-cost measure to provide a buffer between pedestrians waiting at or crossing an intersection. In the future, a Painted Safety Zone has the potential to be built to become a curb extension.
2. It is recommended that Painted Safety Zones be installed at busy and historically unsafe intersections, especially where sight lines are poor.
3. Sources: San Francisco Municipal Transportation Agency (SFMTA) Blog, June 2016, "Painted Safety Zones", <https://www.sfmta.com/about-sfmta/blog/painted-safety-zones>, accessed September 27, 2016; SFMTA Blog, August 2016, "Three Ways Painted Safety Zones Make People Safer", <https://www.sfmta.com/about-sfmta/blog/three-ways-painted-safety-zones-make-people-safer>, accessed September 27, 2016; StreetsBlog SF, June 2015, "SFMTA Plans to Install Painted 'Safety Zones' at 40 Intersections This Year," <http://sf.streetsblog.org/2015/06/25/sf-mta-plans-to-install-painted-safety-zones-at-40-intersections-this-year>, accessed September 27, 2016.
4. The above design guideline is a recommendation for complete streets implementation and does not supersede a jurisdiction's existing standards.

DESIGN GUIDELINE
Truck Turning

Mountable curbs/truck aprons allow truck movements in areas that have limited right-of-way dimensions. They can be applied at intersections, driveways, median noses, and roundabouts.

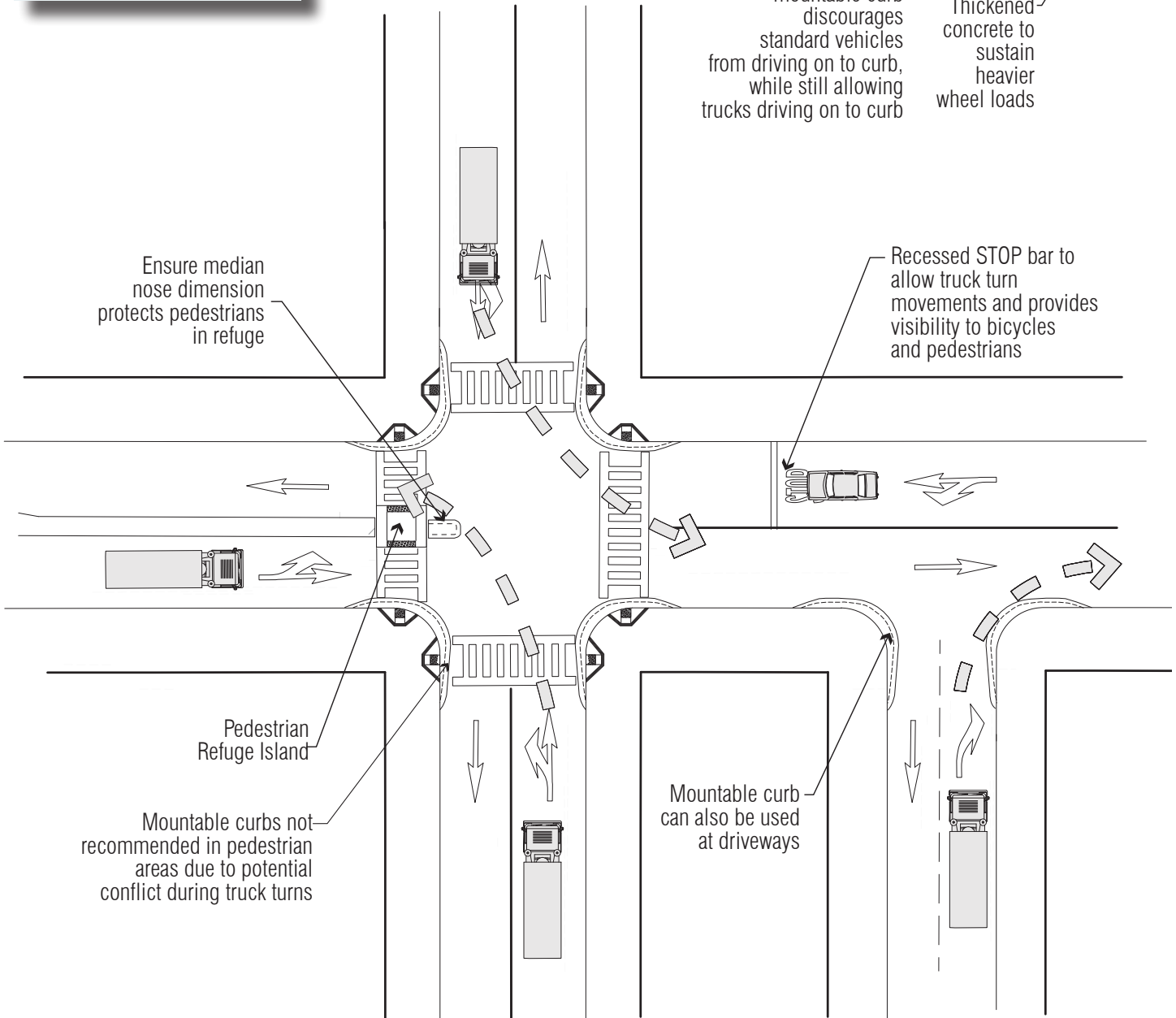
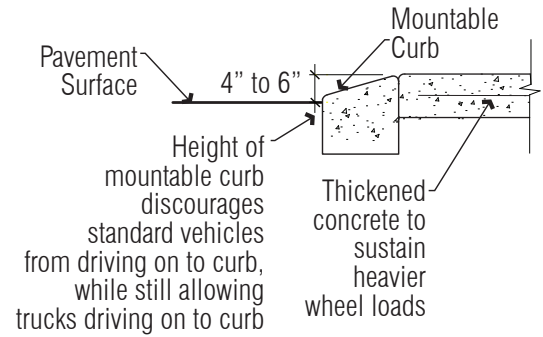

Notes:

1. Sources: City of Portland Office of Transportation, 2008, *Truck Movements and Other Large Vehicles in Portland*, pages 30 to 33; Federal Highway Administration, *Achieving Multimodal Networks: Applying Design Flexibility and Reducing Conflicts*, https://www.fhwa.dot.gov/environment/bicycle_pedestrian/publications/multimodal_networks/part01.cfm, accessed September 28, 2016;
2. The above design guideline is a recommendation for complete streets implementation and does not supersede a jurisdiction's existing standards.